

ADN-C Series

120 - 960 Watts
DIN Rail

Total Power: 120 - 960 Watts
Input Voltage: 85-264 Vac
90-375 Vdc
of Outputs: Single



Special Features

- Slim form factor
- Five year warranty
- High Efficiency > 90% Typ.
- Full Power at 60°C
- Power Boost™
- Industrial Grade Design
Patented metal mounting clip
Metal case
- MTBF > 450Khr demonstrated at 40°C
- Active PFC > 0.92
- Adjustable output
- Overvoltage protection with autorecovery
- Continuous short circuit and overload protection
- SEMI F47 Sag Immunity
- 3 Status LEDs
Input / Output / Alarm
- DCOK Relay
- Parallel operation capability
- Screw terminal connections
- RoHS Compliant
- No tools required for mounting

Safety

- UL 508, cULus Listed
- UL 60950-1, cURus
- IEC 60950-1
- Class I, Div 2 Hazardous Locations
- ATEX Certified on selected models
- IP20
- CE

Product Descriptions

The ADN-C series has improved upon the superior reliability of the ADN Series of AC-DC power supplies with increased Mean Time Between Failure (MTBF) by reducing the part count and strategic use of high quality components. In addition to being extremely reliable by design, the ADN-C has built-in protection from over temperature, overloads and short circuits. This ensures that reliability is not compromised by operation temporarily outside of normal conditions. Intuitive visual diagnostics help ensure easy troubleshooting when such conditions occur so that equipment downtime can be minimized.

The ADN-C series features a universal 85-264 Vac input – enabling it to be used anywhere in the world - and is also capable of operating from a 90-375 Vdc input. The power supply produces a tightly regulated 24V output of up to 960W continuously with convection cooling. The main output can be adjusted over the range from 22.5V to 28.5V (24V to 28V for ADN20-24-1PM-C & ADN40-24-1PM-C) over nominal factory set output voltage of 24.5V.

Active power factor correction is employed to minimize input harmonic current distortion and ensure compliance with the international EN61000-3-2 standard. The power supplies have a full load ambient operating temperature range of -25 to +60 degrees Celsius without derating at convection cooling condition. Operation between 60 and 70 degrees Celsius, the output should be derated by 5 percent per degree.

Model Numbers

Standard	Output Voltage	Minimum Load	Maximum Load	Maximum Power
ADN5-24-1PM-C	24Vdc	0A	5A	120W
ADN10-24-1PM-C	24Vdc	0A	10A	240W
ADN20-24-1PM-C	24Vdc	0A	20A	480W
ADN40-24-1PM-C	24Vdc	0A	40A	960W

Options

None

Electrical Specifications

Absolute Maximum Ratings

Stress in excess of those listed in the “Absolute Maximum Ratings” may cause permanent damage to the power supply. These are stress ratings only and functional operation of the unit is not implied at these or any other conditions above those given in the operational sections of this TRN. Exposure to any absolute maximum rated condition for extended periods may adversely affect the power supply’s reliability.

Table 1. Absolute Maximum Ratings:

Parameter	Model	Symbol	Min	Typ	Max	Unit
Input Voltage						
AC continuous operation	All models	$V_{IN,AC}$	85	-	264	Vac
DC continuous operation	All models	$V_{IN,DC}$	90	-	375	Vdc
Maximum Output Power, continuous	ADN5-24-1PM-C ADN10-24-1PM-C ADN20-24-1PM-C ADN40-24-1PM-C	$P_{O,max}$	- - - -	- - - -	120 240 480 960	W
Isolation Voltage						
Input to output	All models		-	-	2500	Vdc
Input to safety ground	All models		-	-	2500	
Output to safety ground	All models		-	-	100	
Ambient Operating Temperature	All models	T_A	-25	-	+70 ^{1,2}	°C
Storage Temperature	All models	T_{STG}	-40	-	+85	°C
Humidity (non-condensing)						
Operating	All models		5	-	95	%
Non-operating	All models		0	-	95	
Altitude						
Operating	All models		0	-	10,000	feet
Non-operating	All models		-1,000	-	50,000	

Note 1 - Derate each output at 5% per degree C from 60°C to 70°C

Note 2 - Operation up to 50% load permissible with sideways (horizontal) or front side up (top) mounting orientation

Input Specifications

Table 2. Input Specifications:

Parameter	Conditions	Symbol	Min	Typ	Max	Unit
Operating Input Voltage, AC	All	$V_{IN,AC}$	85	115/230	264	Vac
Operating Input Voltage, DC	All	$V_{IN,DC}$	90	-	375	Vdc
Input AC Frequency	All	f_{IN}	43	50/60	67	Hz
Maximum steady state Input Current	ADN5 ADN10 ADN20 ADN40 $V_{IN,AC} = 85Vac$	$I_{IN,max}$	- - - -	- - - -	4 6 8 13	A
Harmonic Line Currents	All	THD	Per EN61000-3-2			
Power Factor	$I_O = I_{O,max}$ $V_{IN,AC} = 85 \text{ to } 264Vac$	PF	0.92	-	-	
Startup Surge Current (Inrush) @ 25°C	ADN5 ADN10 ADN20 ADN40 $V_{IN,AC} = 264Vac$	$I_{IN,surge}$	- - - -	- - - -	15 30 40 60	A_{PK}
Input Fuse	ADN5 ADN10 ADN20 ADN40 Internal, L line 250VAC rated MXEP type		- - - -	- - - -	3 5 10 15	A
Input AC Low Line Start-up Voltage	$I_O = I_{O,max}$	$V_{IN,AC-start}$	70	-	78	Vac
PFC Switching Frequency	All	$f_{SW,PFC}$	43	-	53	kHz
Efficiency ($T_A = 25^\circ C$)	ADN5 ADN10 ADN20 ADN40 $V_{IN,AC} = 230Vac$ $I_O = I_{O,max}$	η	- - - -	90 90 92 94	- - - -	%
Hold Up Time	$V_{IN,AC} = 100Vac$ $P_O = P_{O,max}$ $T_A = 25^\circ C$	$t_{Hold-Up}$	20	-	-	mSec
Turn On Delay	Resistive Load Capacitive Load $V_{IN,AC} = 85Vac$ $I_O = I_{O,max}$	$t_{Turn-On}$	- -	- -	1.0 1.5	Sec

Output Specifications

Table 3. Output Specifications:

Parameter	Condition	Symbol	Min	Typ	Max	Unit
Factory Set Voltage	$I_O = 0A$	$V_{O,Factory}$	24.25	24.50	24.75	V
Output Adjust Range	$I_O = 0A$	V_O	22.5 22.5 24.0 24.0	- - - -	28.5 28.5 28.0 28.0	V
Line / Load Regulation	$V_{IN,AC} = 85 \text{ to } 264V_{ac}$ $I_O = 0 \text{ to } I_{O,max}$	$\%V_O$	-2.0	-	+2.0	%
Total Regulation	Inclusive of line, load temperature change, warm-up drift	$\%V_O$	-2.0	-	+2.0	%
Output Ripple, pk-pk	See note 1	V_O	- - - -	- - - -	50 50 100 100	mV _{PK-PK}
Output Current, continuous	See note 2 and 3	$I_{O,max}$	0 0 0 0	- - - -	5 10 20 40	A
Maximum Output Power, continuous	See note 2 and 3	$P_{O,max}$	- - - -	- - - -	120 240 480 960	W
Output Current, peak	$V_O \geq 20.0V$, 4 sec max	$I_{O,peak}$	- - - -	- - - -	7.5 15 30 60	A
Output Current, short circuit	$V_O \leq 0.5V$, auto recovery	$I_{O,SC}$	160	-	-	$\% I_{O,max}$
Dynamic Response Peak Deviation Setting Time	50% to 100% of $I_{O,max}$ load change Slew rate = $1A/\mu S$ Output capacitance = $100\mu F/A$	$\pm\%V_O$	-	-	2	%
		t_s	-	-	5	mSec
Turn On Overshoot	$I_O = 0$	$\%V_O$	-	-	2	%
Rise Time Resistive Load Capacitive Load	$I_O = I_{O,max}$ $I_O = I_{O,max}$ with $7000\mu F$	t_r	- -	- -	150 500	mSec
DCDC Switching Frequency	All	$f_{SW,DC-DC}$	84	-	90	kHz

Output Specifications

Table 3. Output Specifications, con't:

Parameter	Condition	Symbol	Min	Typ	Max	Unit
Over Voltage Protection	Auto recovery	V _O	30.5	-	33.0	V
Back EMF Immunity	No damage, auto recovery	V _O	-	-	35.0	V
Load Capacitance	Startup	C _O	0	-	7000	μF
Over Temperature Protection	All		Auto Recovery			
MTBF	Telcordia Issue 2, at full load, 40°C		550,000	-	-	Hrs
			550,000	-	-	
			450,000	-	-	
			500,000	-	-	

Note 1 - Measure with a 0.1μF ceramic capacitor in parallel with a 10μF tantalum capacitor using a 20MHz bandwidth limited oscilloscope

Note 2 - Standard operating orientation is front side facing forward.

Note 3 - Operation up to 50% load permissible with sideways (horizontal) or front side up (top) mounting orientation

ADN5-24-1PM-C Performance Curves

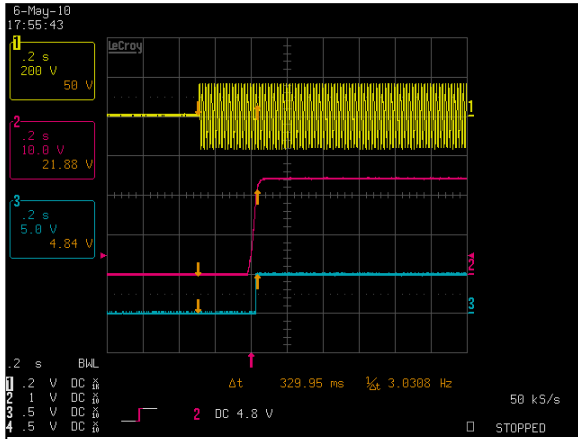

Figure 1: ADN5-24-1PM-C Turn-on delay
 Vin = 115Vac Load: Io = 5.0A
 Ch 1: AC Mains Ch 2: Vo Ch 3: DCOK

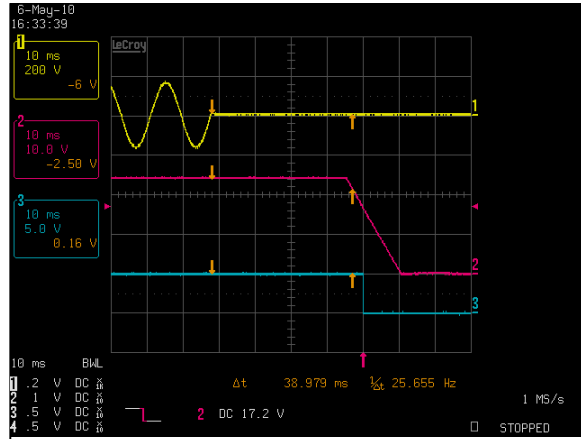

Figure 2: ADN5-24-1PM-C Hold-up Time (time to decay)
 Vin = 115Vac Load: Io = 5.0A
 Ch 1: AC Mains Ch 2: Vo Ch 3: DCOK

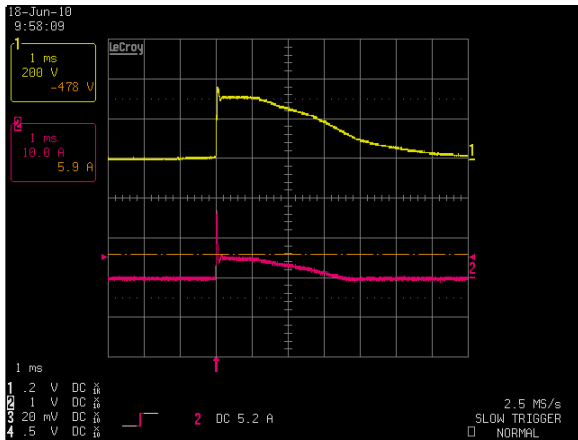

Figure 3: ADN5-24-1PM-C Inrush Current
 Vin = 230Vac Io = 0A, Turn on angle = 90 deg
 Ch 1: AC Mains Ch 2: Io

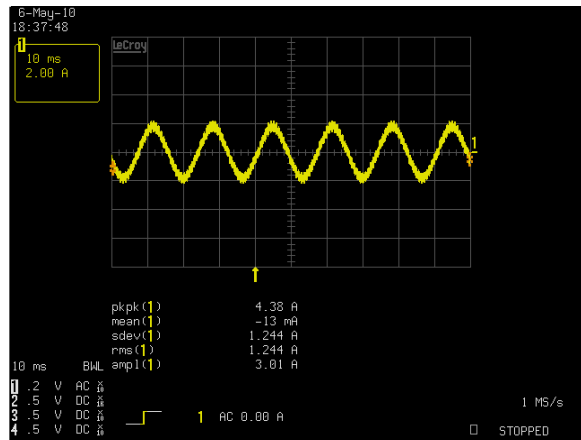

Figure 4: ADN5-24-1PM-C Input Current Waveform
 Vin = 115Vac Io = 5.0A
 Ch 1: Io

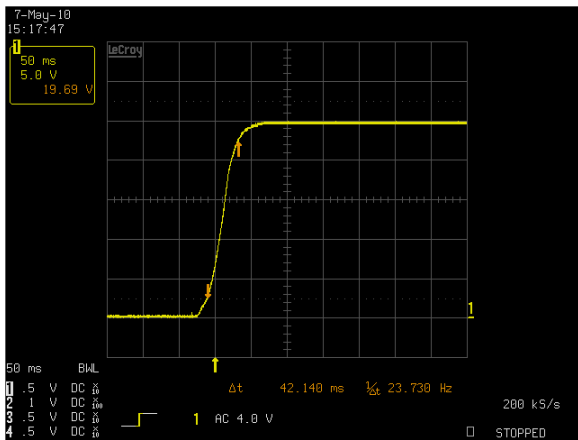

Figure 5: ADN5-24-1PM-C Output Voltage Startup Characteristic
 Vin = 90Vac Io = 5.0A, Output Capacitance = 330uF/A
 Ch 1: Vo

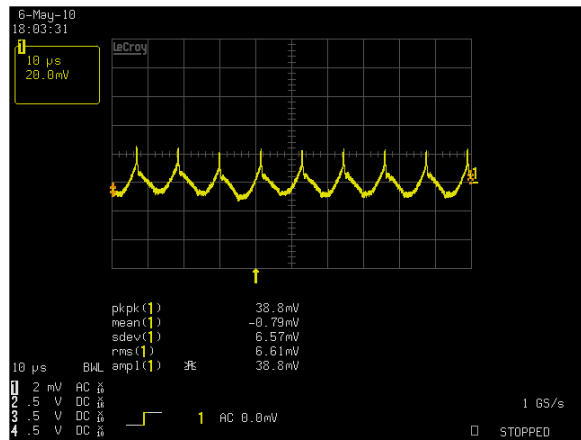

Figure 6: ADN5-24-1PM-C Ripple and Noise Measurement
 Vin = 115Vac Io = 5.0A
 Ch 1: Vo

ADN5-24-1PM-C Performance Curves

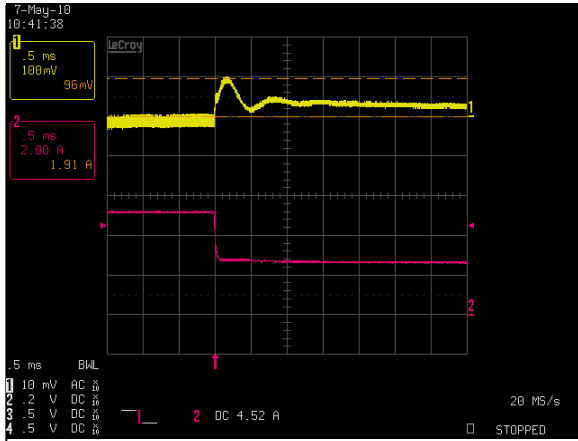

Figure 7: ADN5-24-1PM-C Transient Response – High to Low
100% to 50% load change, 1A/ μ S slew rate V_{in} =115Vac
Ch 1: V_o
Ch 2: I_o

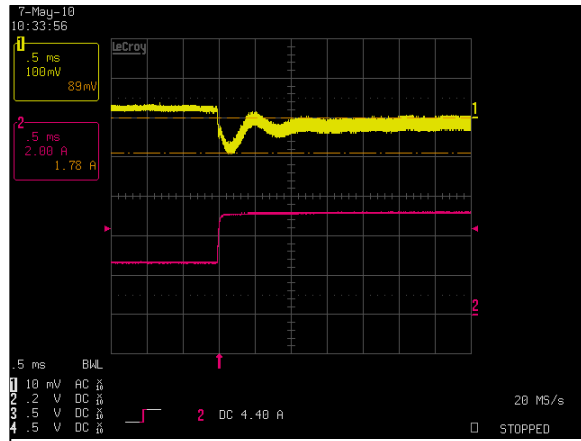
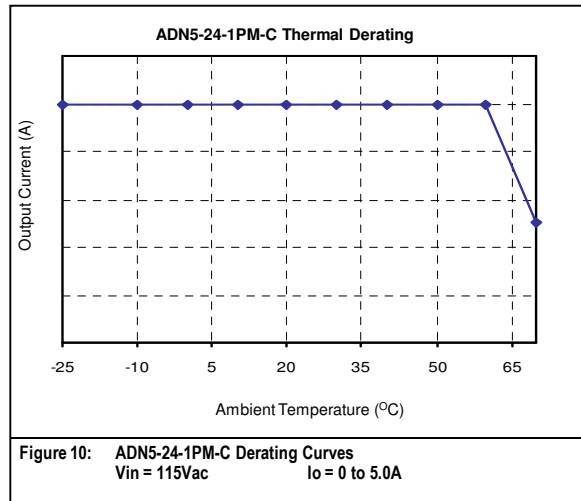
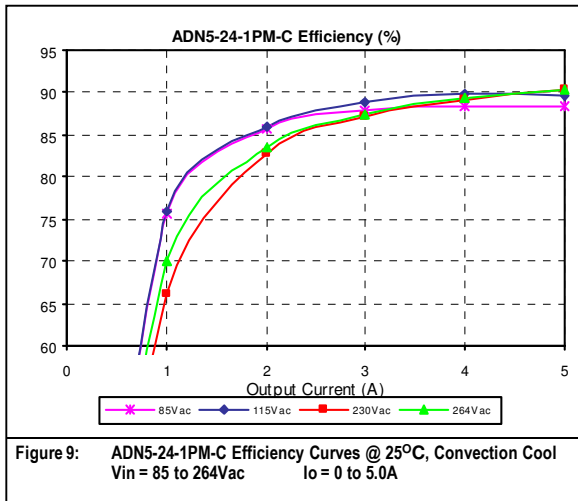

Figure 8: ADN5-24-1PM-C Transient Response – Low to High
50% to 100% load change, 1A/ μ S slew rate V_{in} =115Vac
Ch 1: V_o
Ch 2: I_o



ADN10-24-1PM-C Performance Curves

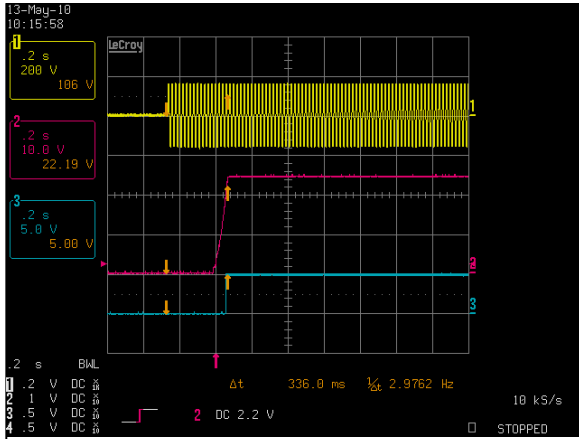

Figure 11: ADN10-24-1PM-C Turn-on delay
Vin = 115Vac Io = 10.0A
Ch 1: AC Mains Ch 2: Vo Ch3: DCOK

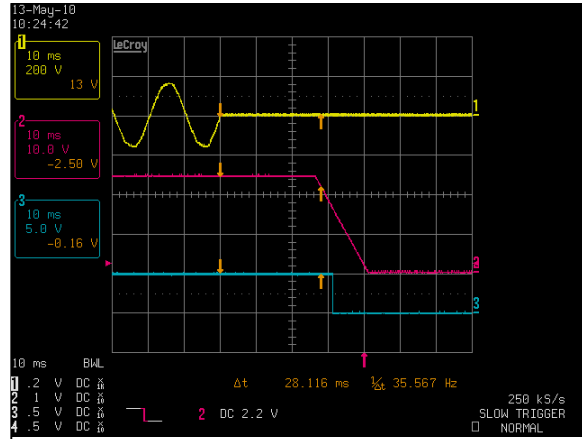

Figure 12: ADN10-24-1PM-C Hold-up Time (time to decay)
Vin = 115Vac Io = 10.0A
Ch 1: AC Mains Ch 2: Vo Ch 3: DCOK

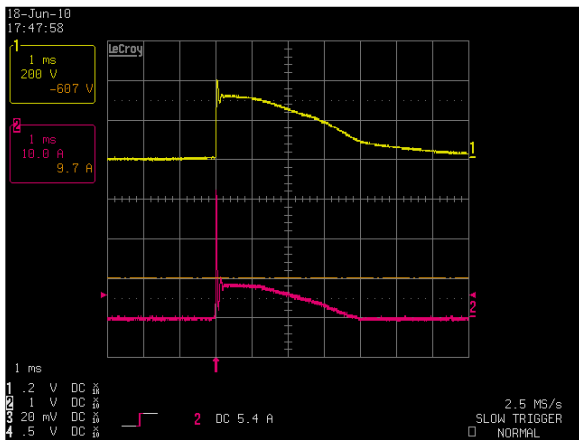

Figure 13: ADN10-24-1PM-C Inrush Current
Vin = 230Vac Io = 0A, Turn on angle = 90 deg
Ch 1: AC Mains Ch 2: I_{IN}

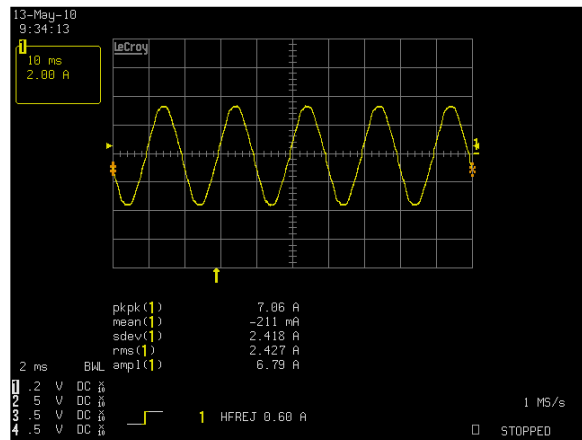

Figure 14: ADN10-24-1PM-C Input Current Waveform
Vin = 115Vac Io = 10.0A
Ch 1: I_{IN}

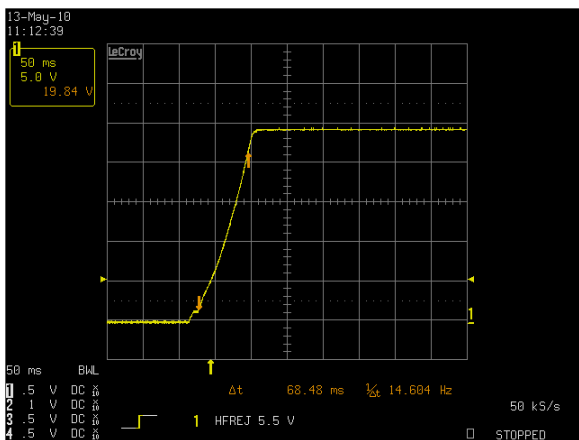

Figure 15: ADN10-24-1PM-C Output Voltage Startup Characteristic
Vin = 90Vac Io = 10.0A, Output Capacitance = 330uF/A
Ch 1: Vo

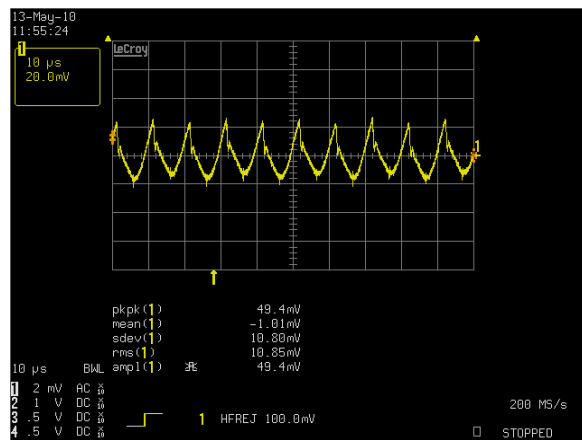

Figure 16: ADN10-24-1PM-C Ripple and Noise Measurement
Vin = 115Vac Io = 10.0A
Ch 1: Vo

ADN10-24-1PM-C Performance Curves

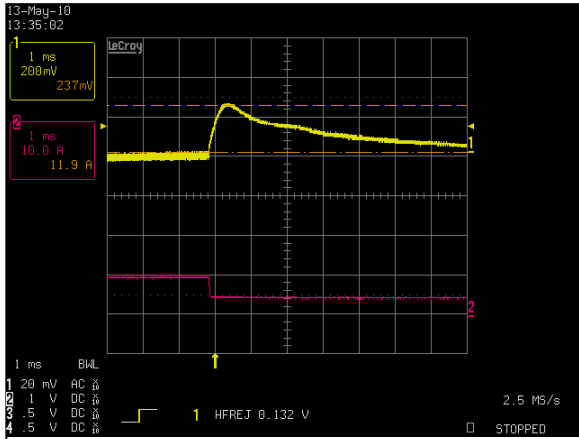

Figure 17: ADN10-24-1PM-C Transient Response – High to Low
100% to 50% load change, 1A/ μ S slew rate, Vin = 115Vac
Ch 1: Vo
Ch 2: Io

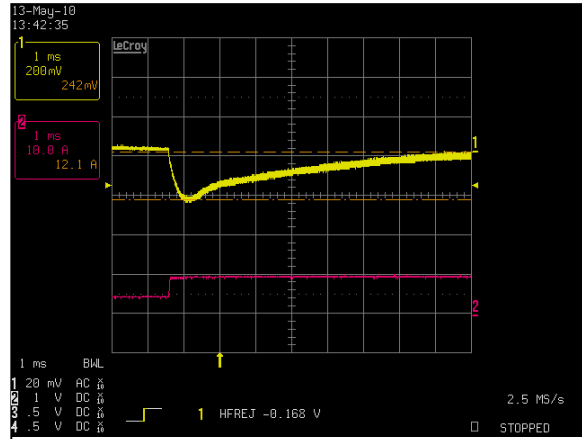
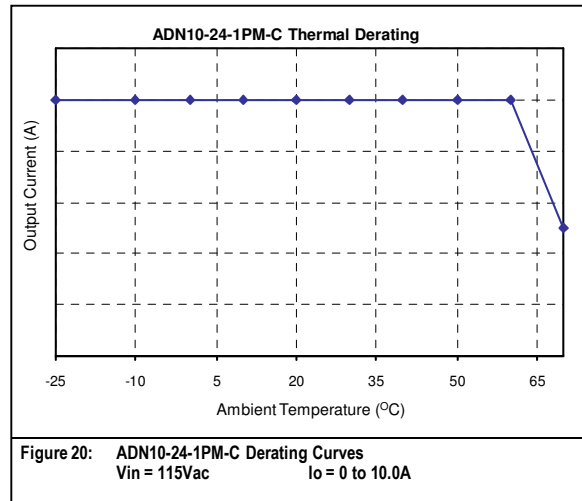
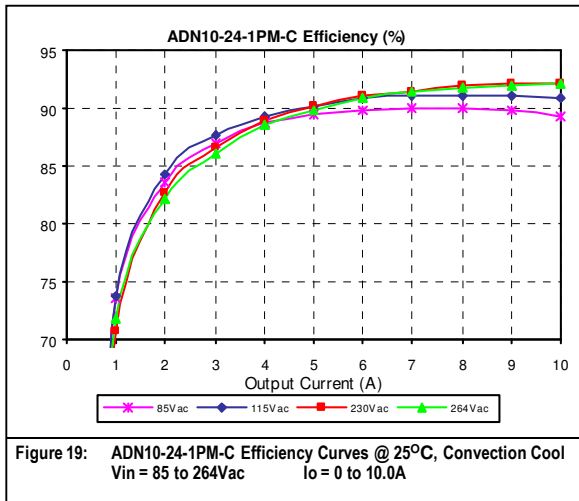

Figure 18: ADN10-24-1PM-C Transient Response – Low to High
50% to 100% load change, 1A/ μ S slew rate, Vin = 115Vac
Ch 1: Vo
Ch 2: Io



ADN20-24-1PM-C Performance Curves

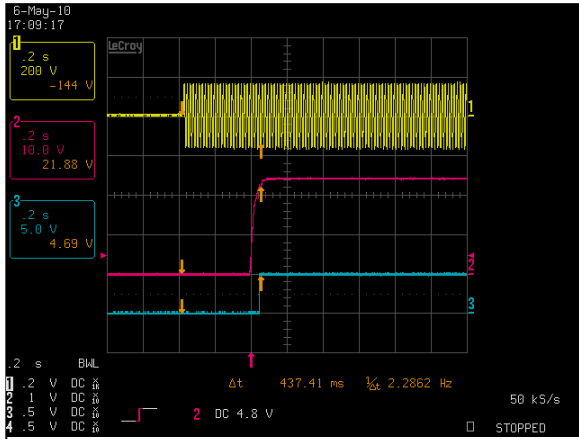

Figure 21: ADN20-24-1PM-C Turn-on delay
Vin = 115Vac Load: Io = 20.0A
Ch 1: AC Mains Ch 2: Vo Ch 3: DCOK

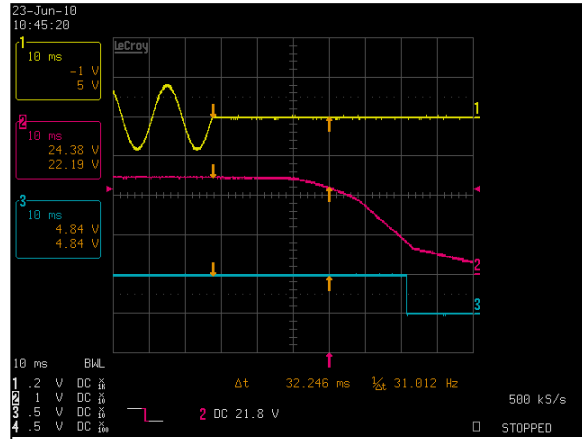

Figure 22: ADN20-24-1PM-C Hold-up Time (time to decay)
Vin = 115Vac Load: Io = 20.0A
Ch 1: AC Mains Ch 2: Vo Ch 3: DCOK

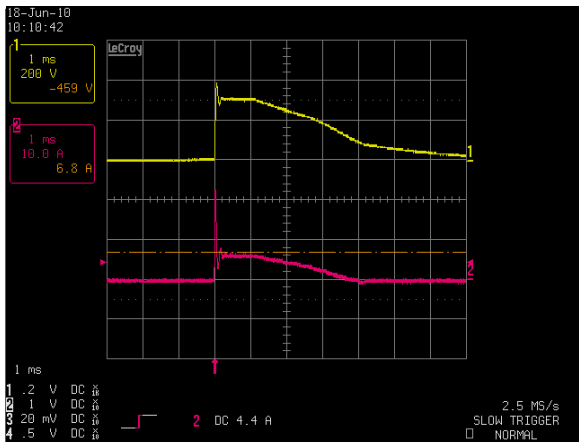

Figure 23: ADN20-24-1PM-C Inrush Current
Vin = 230Vac Io = 0A, Turn on angle = 90 deg
Ch 1: AC Mains Ch 2: I_{IN}

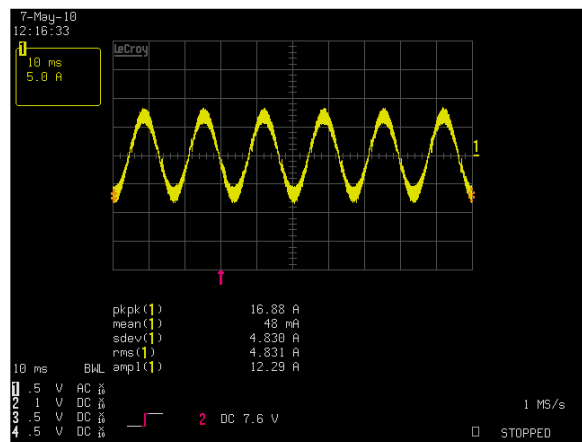

Figure 24: ADN20-24-1PM-C Input Current Waveform
Vin = 115Vac Io = 20.0A
Ch 1: I_{IN}

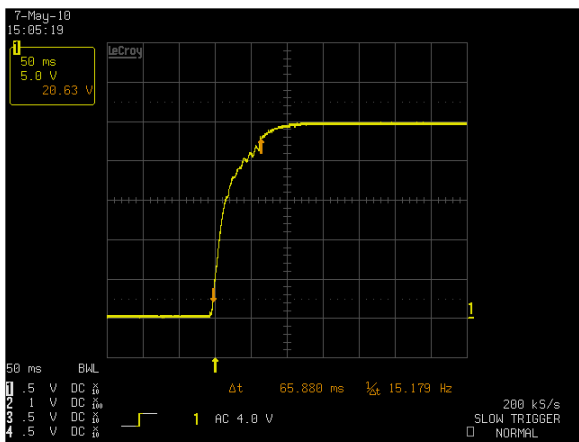

Figure 25: ADN20-24-1PM-C Output Voltage Startup Characteristic
Vin = 90Vac Io = 20.0A, Output Capacitance = 330uF/A
Ch 1: Vo

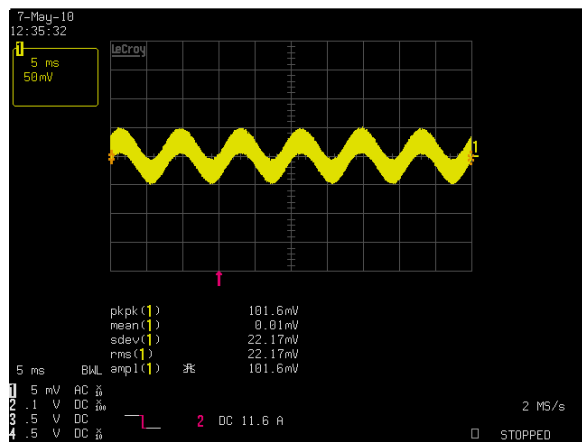

Figure 26: ADN20-24-1PM-C Ripple and Noise Measurement
Vin = 115Vac Io = 20.0A
Ch 1: Vo

ADN20-24-1PM-C Performance Curves

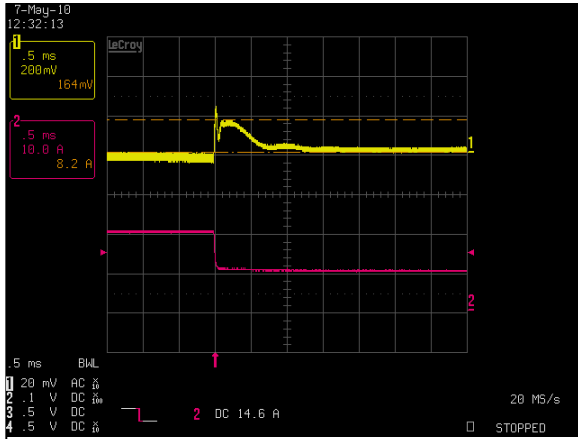

Figure 27: ADN20-24-1PM-C Transient Response – High to Low
100% to 50% load change, 1A/ μ S slew rate, V_{in} = 115Vac
Ch 1: V_o
Ch 2: I_o

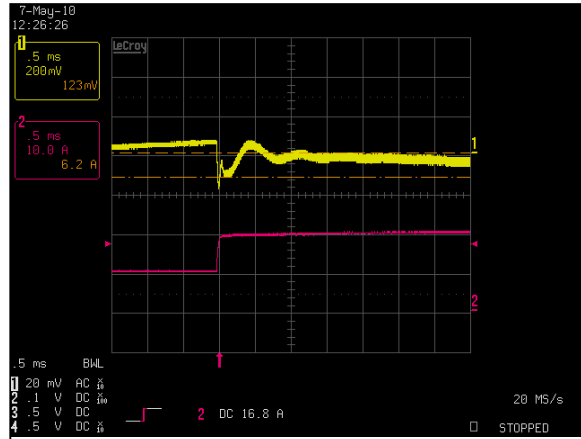
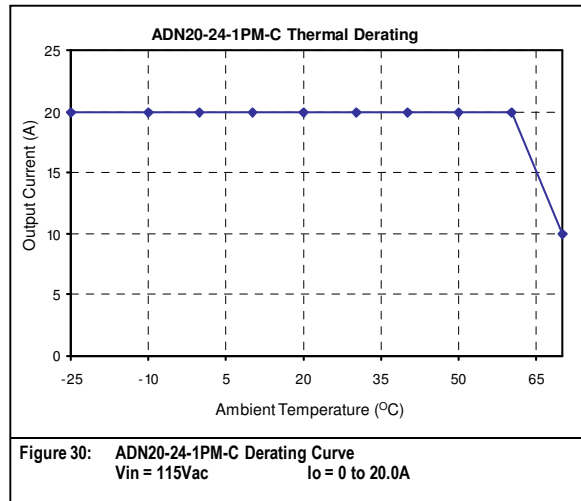
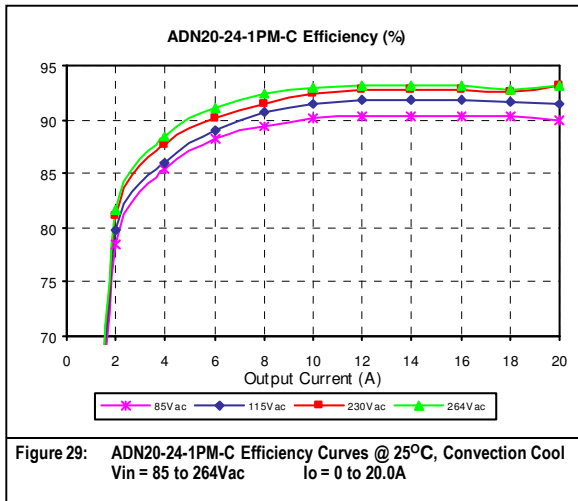

Figure 28: ADN20-24-1PM-C Transient Response – Low to High
50% to 100% load change, 1A/ μ S slew rate, V_{in} = 115Vac
Ch 1: V_o
Ch 2: I_o



ADN40-24-1PM-C Performance Curves

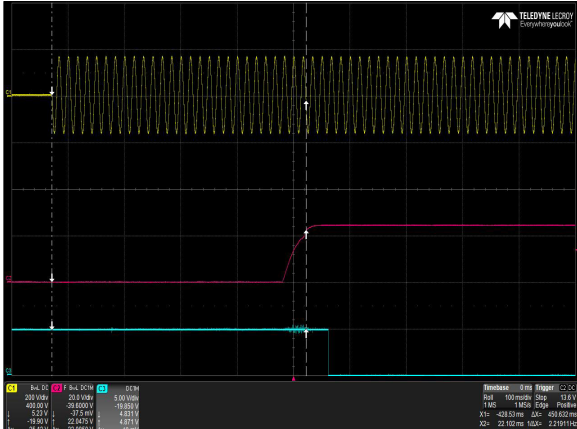

Figure 31: ADN40-24-1PM-C Turn-on delay
 Vin = 115Vac Load: Io = 40.0A
 Ch 1: AC Mains Ch 2: Vo Ch 3: DCOK

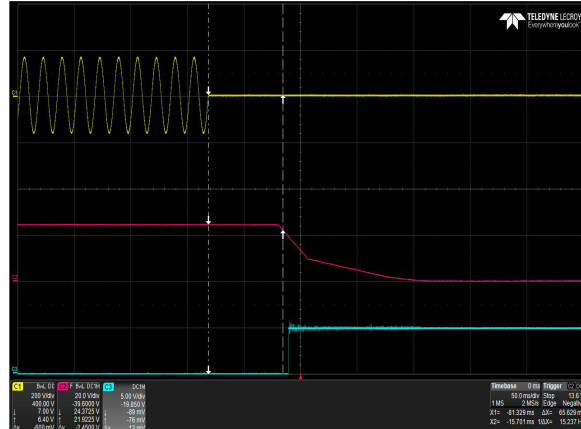

Figure 32: ADN40-24-1PM-C Hold-up Time (time to decay)
 Vin = 115Vac Load: Io = 40.0A
 Ch 1: AC Mains Ch 2: Vo Ch 3: DCOK

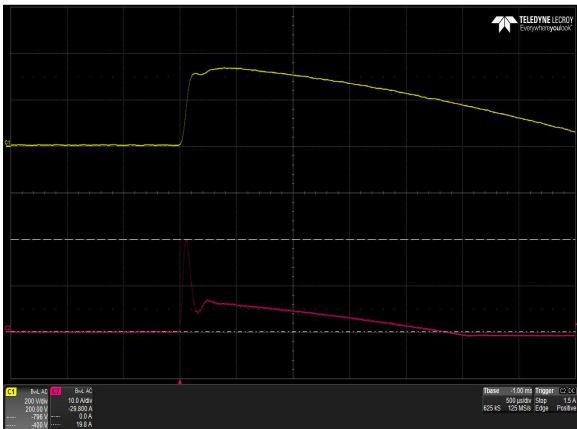

Figure 33: ADN40-24-1PM-C Inrush Current
 Vin = 230Vac Io = 0A, Turn on angle = 90 deg
 Ch 1: AC Mains Ch 2: I_{IN}

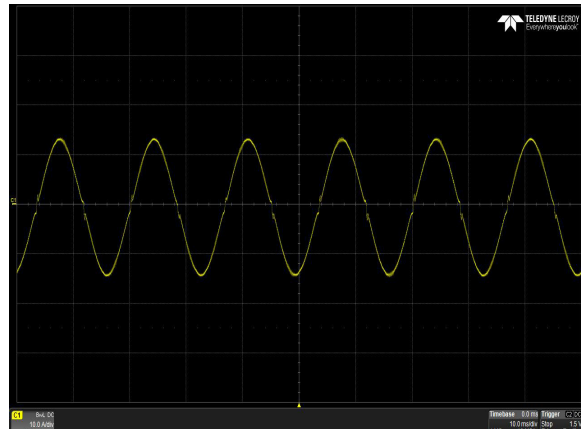

Figure 34: ADN40-24-1PM-C Input Current Waveform
 Vin = 115Vac Io = 40.0A
 Ch 1: I_{IN}

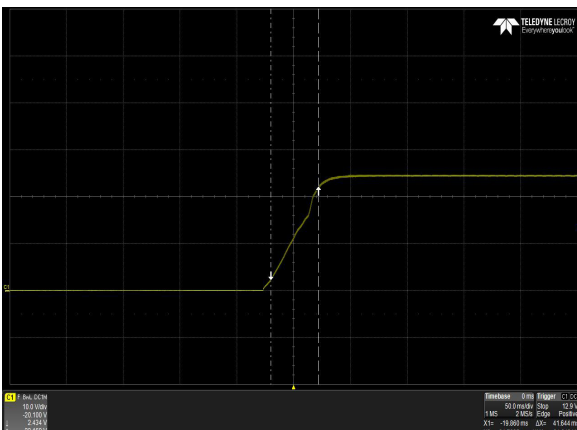

Figure 35: ADN40-24-1PM-C Output Voltage Startup Characteristic
 Vin = 90Vac Io = 40.0A, Output Capacitance = 330uF/A
 Ch 1: Vo

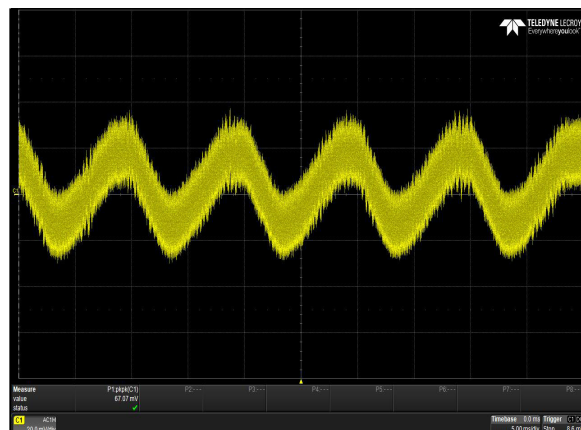

Figure 36: ADN40-24-1PM-C Ripple and Noise Measurement
 Vin = 115Vac Io = 40.0A
 Ch 1: Vo

ADN40-24-1PM-C Performance Curves

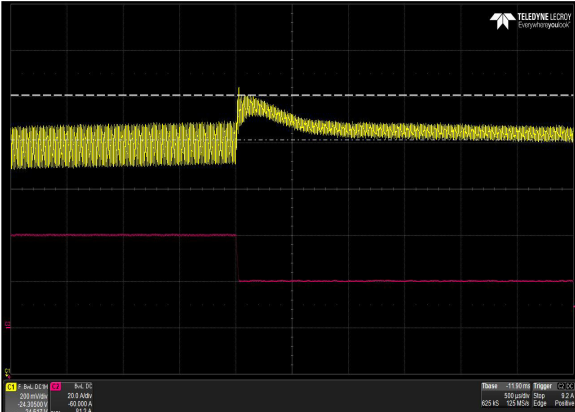

Figure 37: ADN40-24-1PM-C Transient Response – High to Low
100% to 50% load change, 1A/ μ S slew rate, $V_{in} = 115V_{ac}$
Ch 1: V_o
Ch 2: I_o

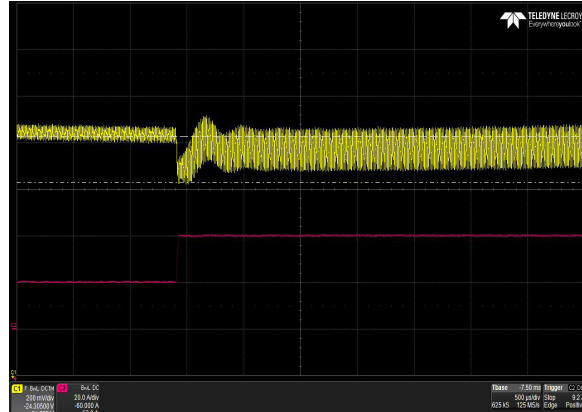

Figure 38: ADN40-24-1PM-C Transient Response – Low to High
50% to 100% load change, 1A/ μ S slew rate, $V_{in} = 115V_{ac}$
Ch 1: V_o
Ch 2: I_o

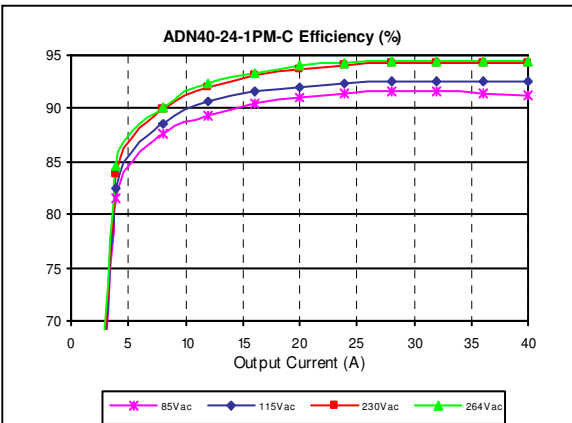

Figure 39: ADN40-24-1PM-C Efficiency Curves @ 25°C, Convection Cool
 $V_{in} = 85$ to $264V_{ac}$ $I_o = 0$ to $40.0A$

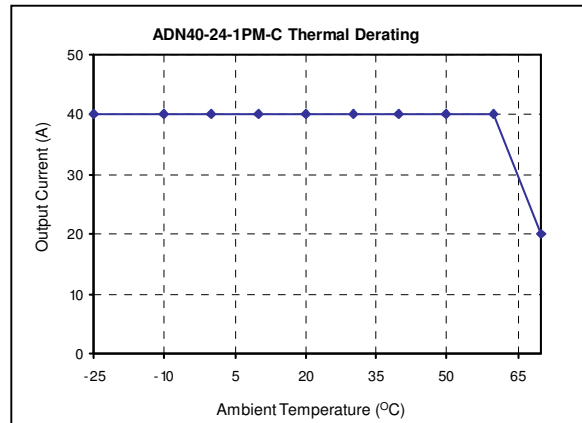

Figure 40: ADN40-24-1PM-C Derating Curve
 $V_{in} = 115V_{ac}$ $I_o = 0$ to $40.0A$

Protection Function Specifications

Over Voltage Protection (OVP)

The power supply main Vo output will shutdown and auto recover after remove output over voltage.

Parameter	Min	Nom	Max	Unit
V _O Output Overvoltage	30.5	/	33.0	V

Over Current Protection and PowerBoost™

With PowerBoost™, the ADN-C power supplies can supply a higher output current for a short period of time without the output voltage breaking down. When an overload occurs, the output current can increase up to 1.5 times its nominal rating for four seconds. If the overload lasting for longer than 4 seconds, the power supply will go into hiccup mode for protection. Refer to PowerBoost™ diagram below for details.

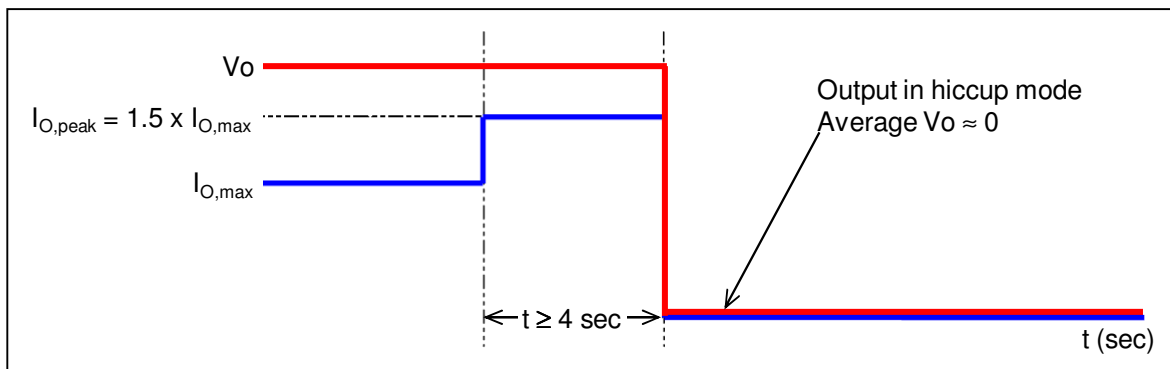

Short Circuit Protection (SCP)

The ADN-C series power supply is protected against short circuit to its output. A short circuit is defined as 0.03 ohm resistance or less between the output terminals. When a short circuit condition occurs, the output current can reach 160% of the rated current or higher, the output will shut off immediately and goes into hiccup mode.

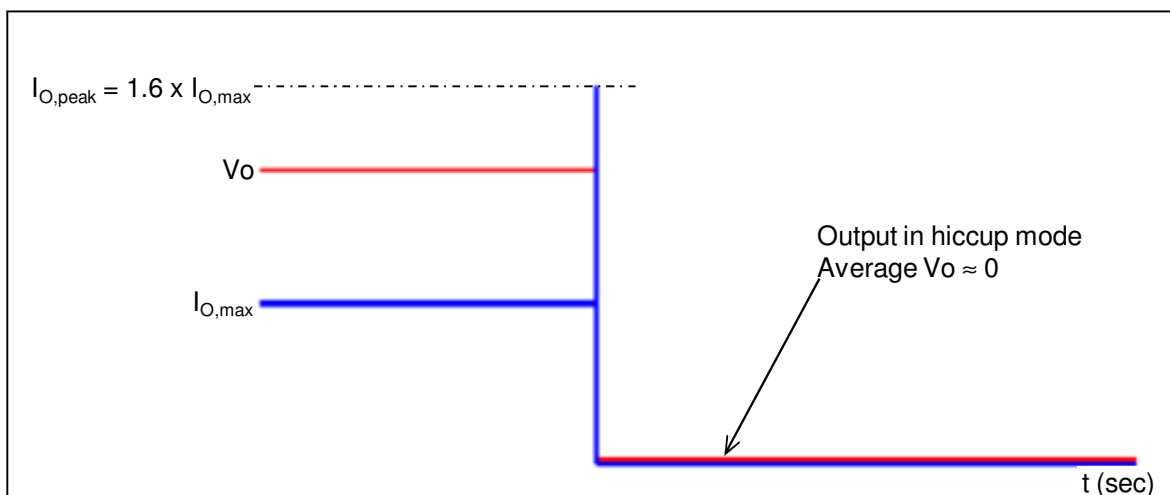

Mechanical Specifications

Mechanical Outlines

ADN5-24-1PM-C

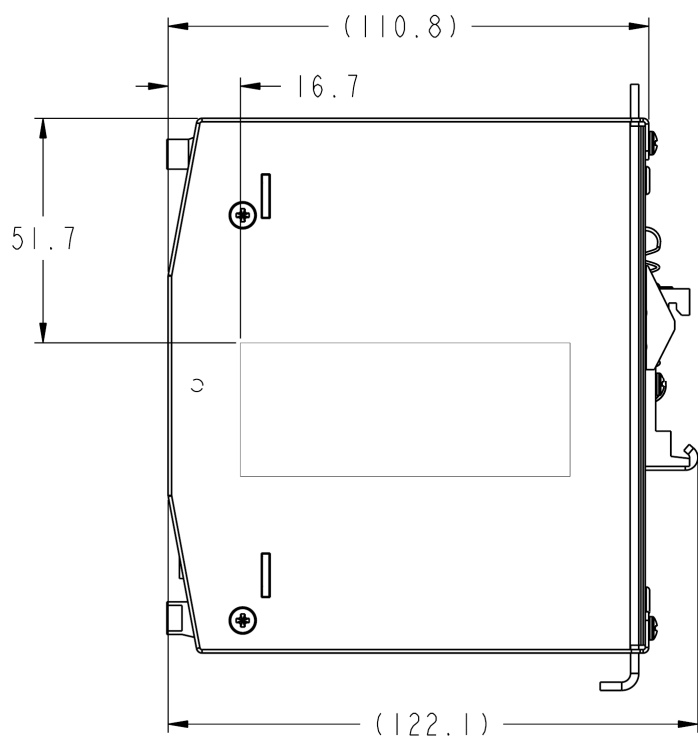
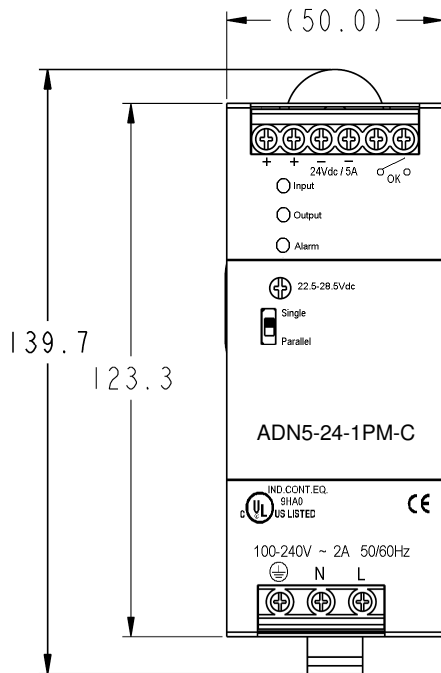
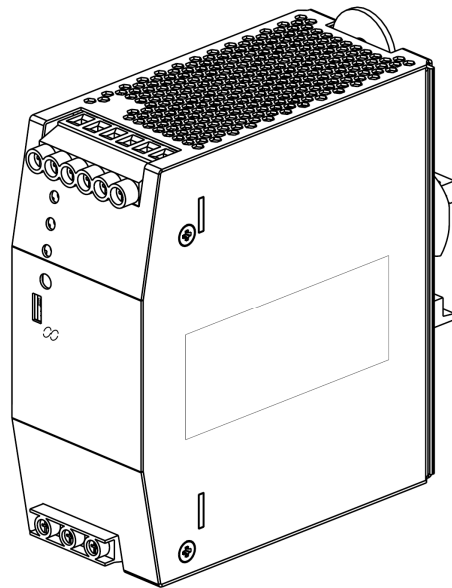
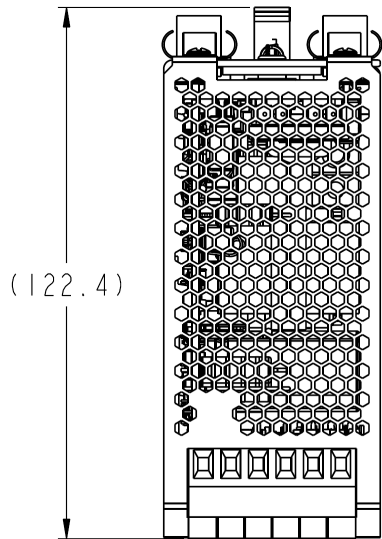

Mechanical Outlines

ADN10-24-1PM-C

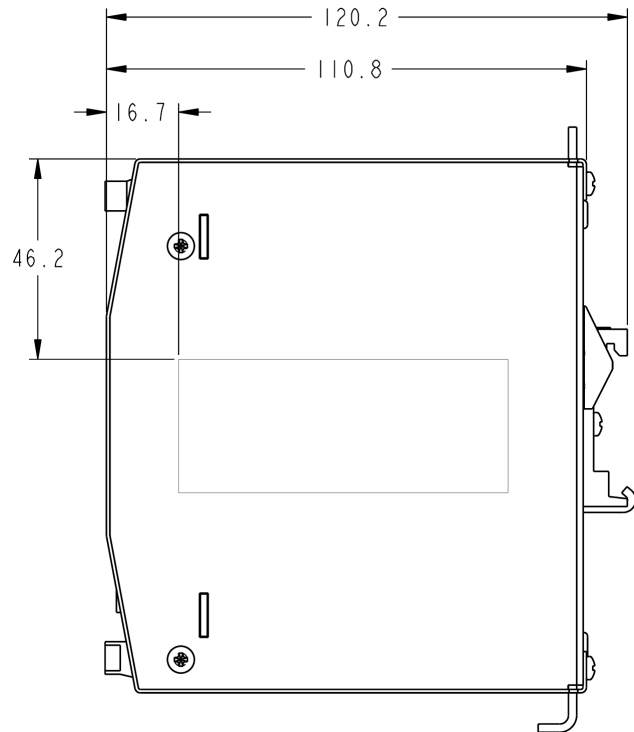
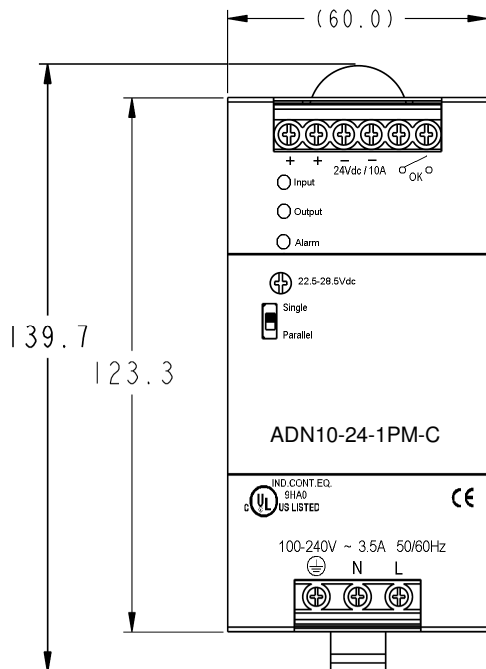
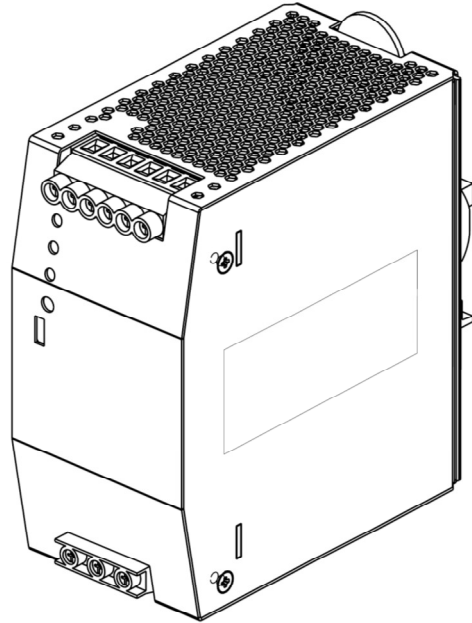
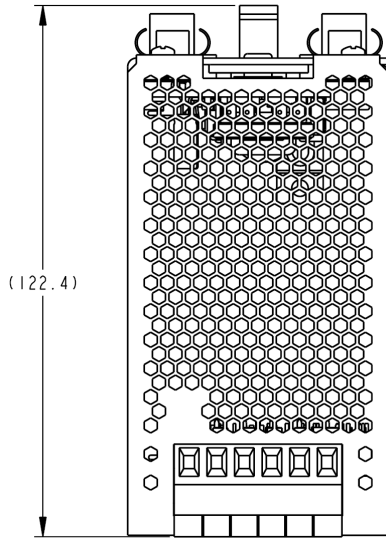

Mechanical Outlines

ADN20-24-1PM-C

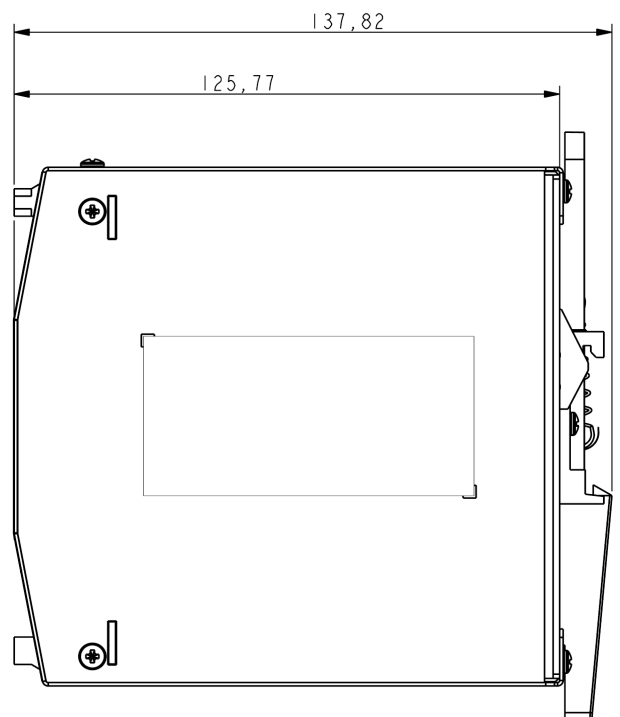
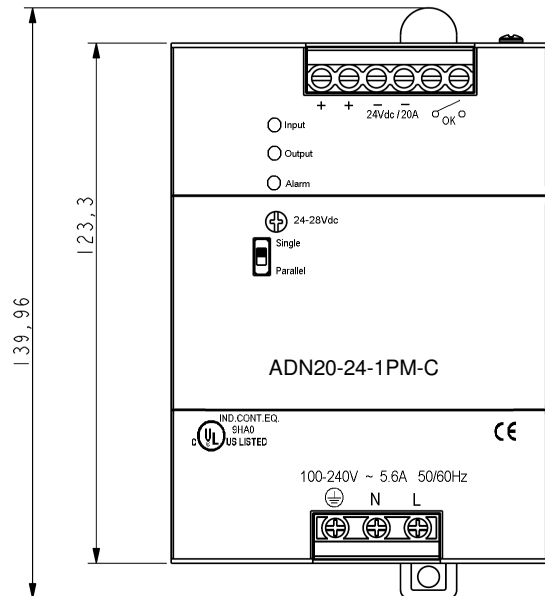
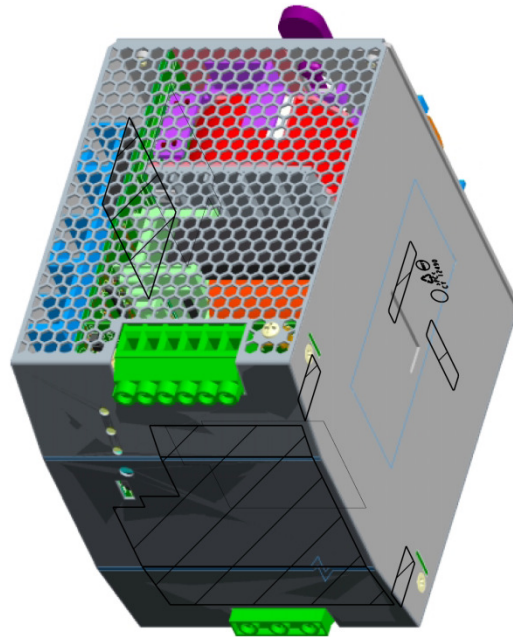
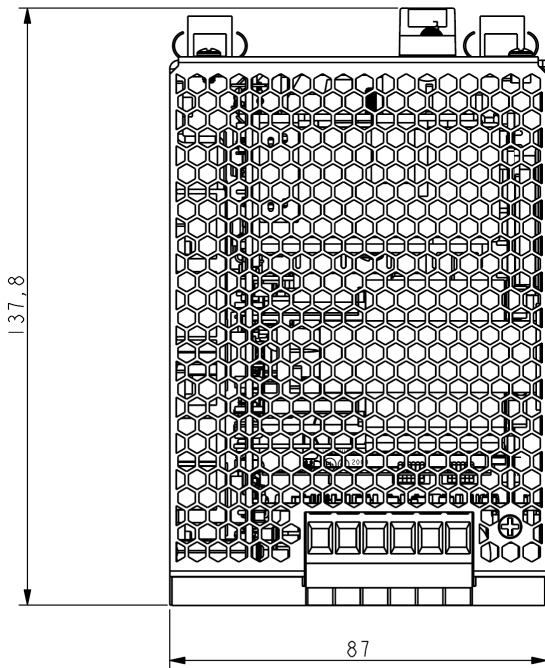

Mechanical Outlines

ADN40-24-1PM-C

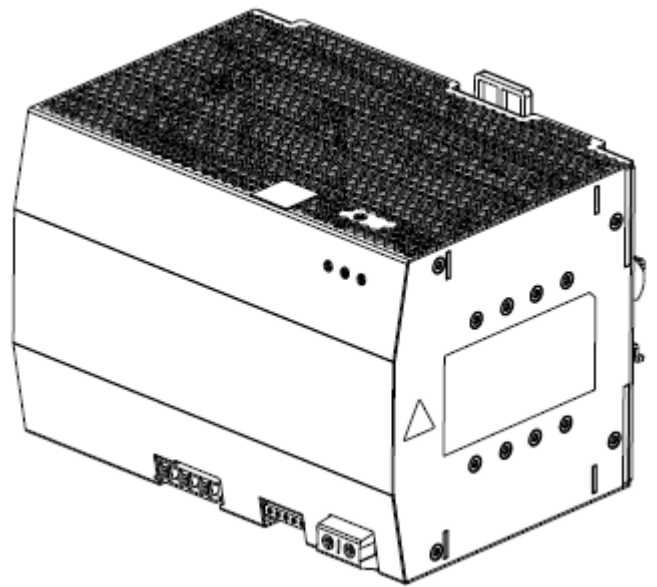
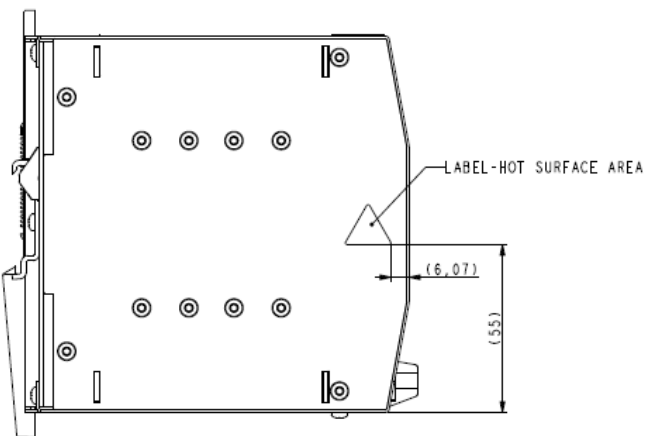
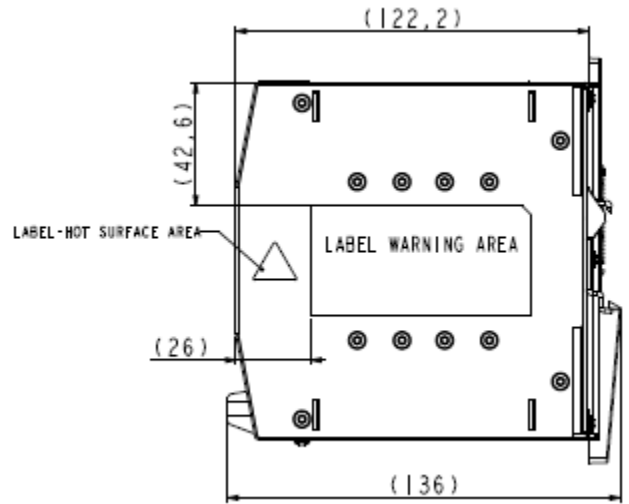
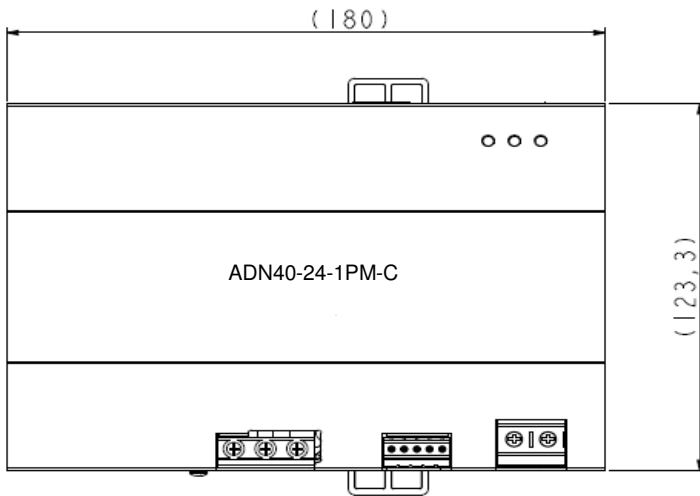

Mounting

DIN rail mounting (DIN TS35/7.5 or TS35/15 rail system)

1. Tilt unit slightly backwards
2. Put it onto the DIN Rail
3. Push downwards until stopped
4. Push at the lower front edge to lock
5. Shake the unit slightly to ensure that the retainer has locked

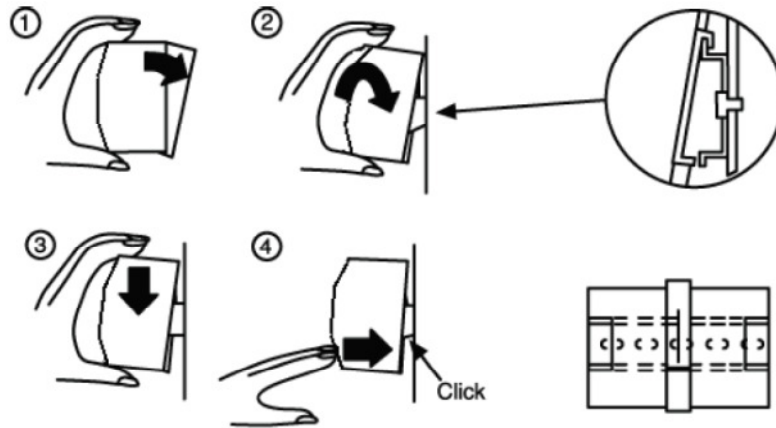

Alternative Panel Mount: Using the optional accessory, the unit can be screw mounted to a panel.

Detachment from DIN rail:

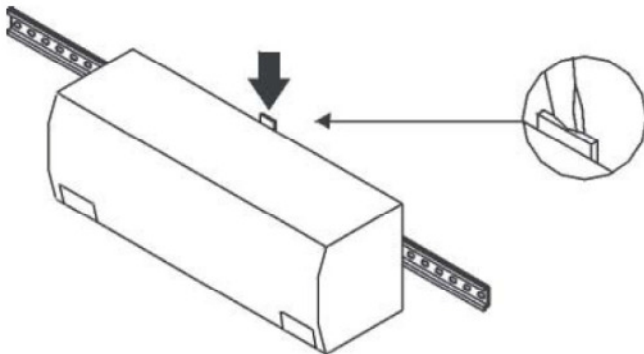

Chassis mounting

Instead of mounting on DIN rail, a ADN-C series power supply can also be attached to chassis by using two metal brackets, which replace the existing two aluminum profiles.

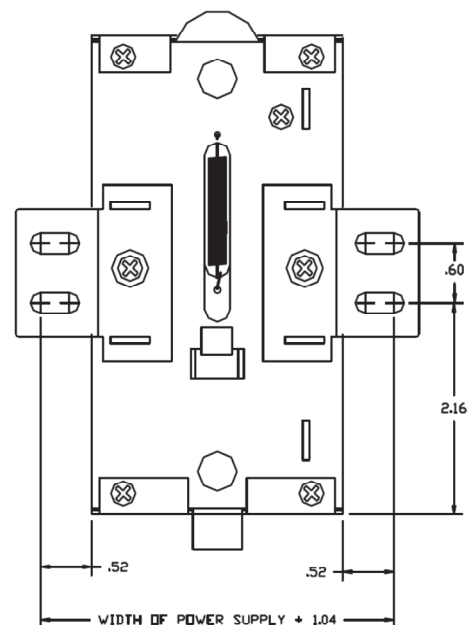
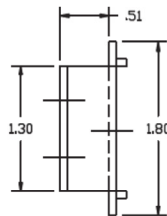
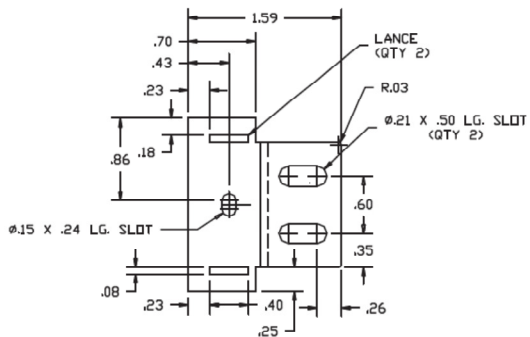

Mounting Orientations

Vertical (Standard)

- AC Input connector on TOP
- LED indicators face FRONT
- No derating require

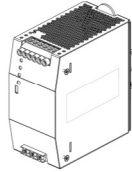

Horizontal (Sideways mount)

- AC Input and Output connectors on horizontal plane
- LED indicators face FRONT
- Maximum output = 50% rated output current

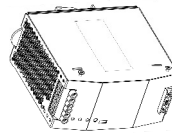

Top mount (Front side up)

- LED indicators face UP
- Maximum output = 50% rated output current

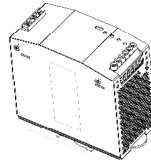

Mounting Space

Free space (minimum)

- | | |
|--------------------------------|--|
| ADN5-24-1PM-C / ADN10-24-1PM-C | - 15mm in front, 25mm above and below, 10mm left and right |
| ADN20-24-1PM-C | - 15mm in front, 40mm above and below, 10mm left and right |
| ADN40-24-1PM-C | - 15mm in front, 25mm above and below, 25mm left and right |

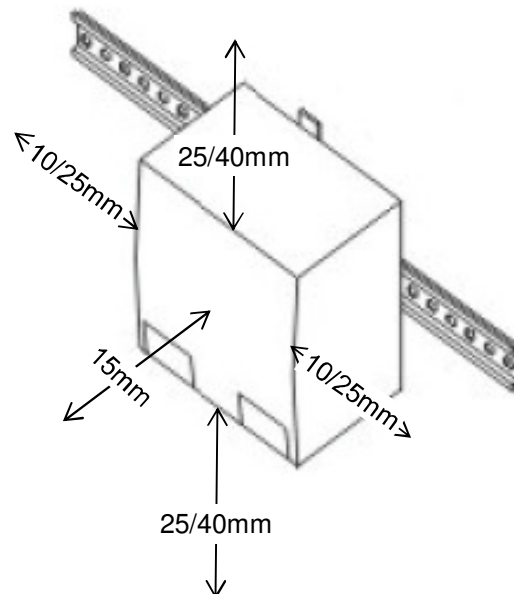

Connector Definitions

AC Input Connector

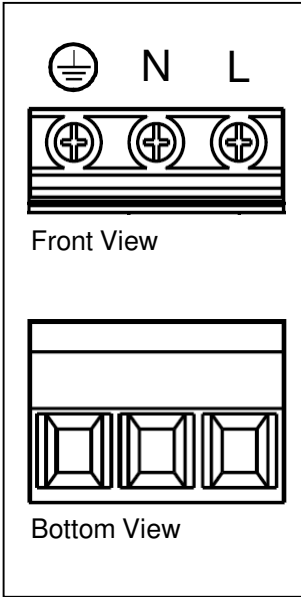

Output Connector

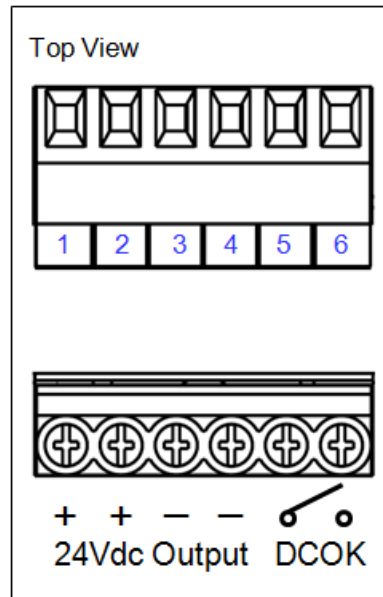

Output Connector (For ADN40 only)

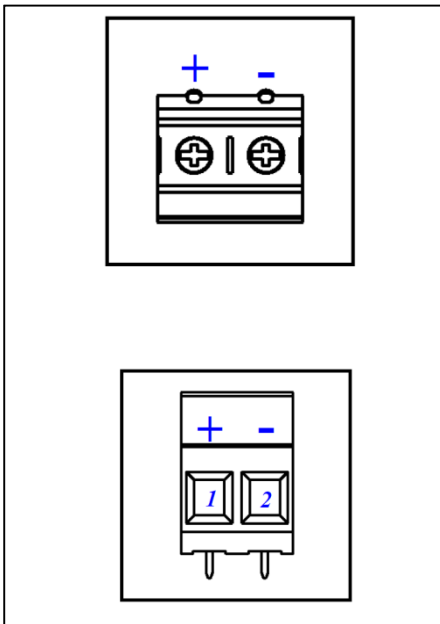

Signal Connector (For ADN40 only)

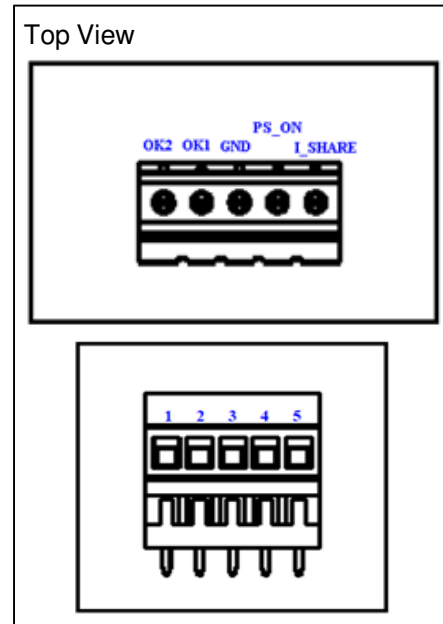

AC Input Connector

These terminals supply the AC Mains to the ADN-C series power supply.

- Pin 1 - Earth Ground (Safety Ground)
- Pin 2 - Neutral
- Pin 3 - Line

Output Connector

These terminals provide the main output for the ADN-C power supply and the DCOK contact output.

- Pin 1 & 2 - (+) 24V Output (Vo)
- Pin 3 & 4 - (-) 24V Output (Vo Return)
- Pin 5 & 6 - DCOK

The Vo and the Vo Return terminals are the positive and negative rails, respectively of the main output of the ADN-C series power supply. The Main Output is electrically isolated from the Earth Ground and can be operated as a positive or negative output.

DCOK – (Pin 5 and Pin 6)

DCOK is a dry relay contact output capable of switching up to a maximum of 0.2A / 50Vdc

- Relay contact close - DC OK - Output 24V available
- Relay contact open - DC Fail - Output 24V failed

Signal Connector (ADN40 only)

- Pin 1 - OK2 (DC OK2 Signal)
- Pin 2 - OK1 (DC OK1 Signal)
- Pin 3 - GND (Ground)
- Pin 4 - PS_ON (Active low remote power on)
- Pin 5 - I_SHARE (Share voltage at parallel operation)

Connector Type and Wire Sizes

Table 4. Connector type on ADN-C series

Reference		Description	Wire Size
Input AC Connector	All models	3-Pole, 9.52mm Pitch, Euro Type, Cage Clamp Terminal Block	16 to 10 AWG (1.5 to 6 mm ²) solid wire
Output Connector	ADN5-24-1PM-C ADN10-24-1PM-C ADN20-24-1PM-C	6-Pole, 6.35mm Pitch, Euro Type, Cage Clamp Terminal Block	16 to 10 AWG (1.5 to 6 mm ²) solid wire
	ADN40-24-1PM-C	2-Pole, 10.16mm Pitch, Euro Type, Cage Clamp Terminal Block	7 to 6 AWG (10.6 to 13 mm ²) solid wire
Signal Connector	ADN40-24-1PM-C	5-Pole, 3.81mm Pitch, Euro Type, Cage Clamp Terminal Block	30 to 14 AWG (0.05 to 2 mm ²) solid wire

Switches and Potentiometer Definitions

Vo adjustment – The output of the ADN-C series power supply can be adjusted from its nominal output voltage via the front trim pot screw. Clockwise rotation will increase the output voltage while counterclockwise rotation will decrease the output voltage.

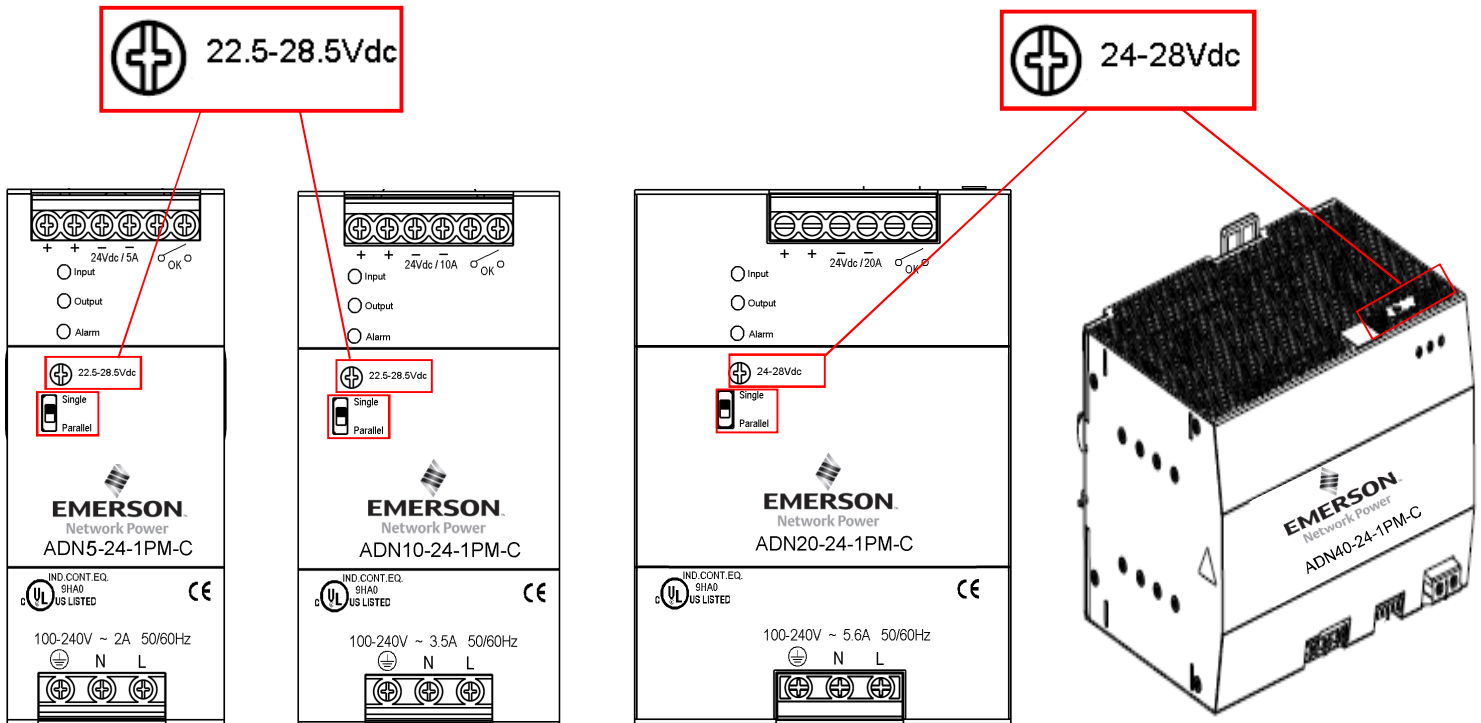

Single / Parallel switch - The outputs of two or more of ADN-C series power supplies can be connected in parallel to increase the total current capability. When operate the ADN-C power supplies in parallel, the Single / Parallel switch on each of the ADN-C power supply should be placed in the parallel position. Units will not be damaged by parallel operation (regardless of switch position setting)

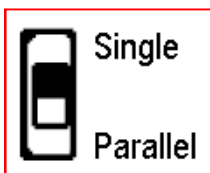

LED Indicator Definitions

Three user-friendly LEDs for status and diagnostics shows status of input power, output power and alarm condition. Valuable troubleshooting aid to reduce system downtime.

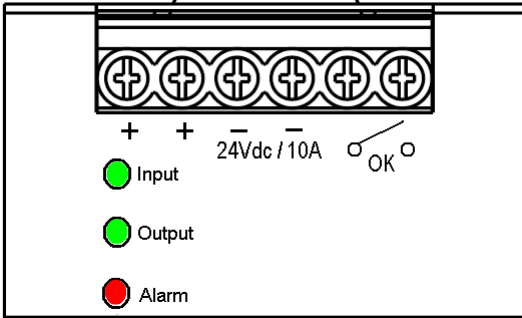

LED Diagnostics								
LED	Normal	ACOOR	DCHL	DC Fail	AC Fail	Overload	OTPending	OTShutdown
● Input	Green	Amber	Green	Green	Off	Green	Green	Green
● Output	Green	Green	Amber	Off	Off	Amber	Green	Off
● Alarm	Off	Off	Amber	Red	Off	Red	Amber	Amber

Normal - AC input in range and DC output OK.

ACOOR - AC out of Range. AC input < 85Vac

DCHL - DC Heavy Load. Output current > 90% of Nominal load current

DC Fail - DC Failure. Output shutdown, but AC is good

AC Fail - AC Failure. AC failure leading to output failure

Overload - DC failure due to overcurrent. Output current > 110% of Nominal load current

OTPending - Over Temperature Pending. Unit near OTP shutdown

OTShutdown - Over Temperature Shutdown. Unit shutdown due to OTP

Weight

ADN5-24-1PM-C	- 1.10 lb (0.50kg)
ADN10-24-1PM-C	- 1.98 lb (0.90kg)
ADN20-24-1PM-C	- 2.60 lb (1.20kg)
ADN40-24-1PM-C	- 6.00 lb (2.75kg)

Environmental Specification

EMC Immunity

The ADN-C Series power supply is designed to meet the following EMC immunity specifications

Table 5. Environmental Specifications:

Document	Description
EN55011, Class B	Limits and methods of measurement of radio disturbance characteristics of industrial, scientific and medical (ISM) radiofrequency equipment
EN55022, Radiated and Conducted including Annex A	Information technology equipment. Radio disturbance characteristics. Limits and methods of measurement
EN61000-3-2	EMC limits for harmonic current emissions for equipment with input current up to and including 16A per phase
EN61000-6-3: 2001	EMC Emission standard for residential, commercial and light industrial environments
EN61000-6-1: 2001	Immunity Standard for Residential, Commercial and Light-Industrial Environments
EN61000-6-2: 2001	Immunity Standard for Industrial Environments
EN61000-4-2 Level 4	ESD, Electrostatic Discharge
EN61000-4-3 Level 3	Radiated, radio-frequency, electromagnetic field immunity test
EN61000-4-4 Level 4 input EN61000-4-4 Level 3 output	Electrical Fast Transient/Burst Immunity Test
EN61000-4-5 Isolation Class 4	Surge immunity test
EN61000-4-6 Level 3	Immunity to conducted disturbances, induced by radio-frequency fields
EN61000-4-11	EMC standard is applicable to power supplies whose input current (I_{IN}) is below 16A
IEC 61000-4-34	Voltage dip immunity standard
SEMI F47 Sag Immunity	

Safety Certifications

The ADN-C series is suitable for use in Class I, Division 2, Groups A, B, C, and D hazardous locations or non-hazardous locations only.

The ADN-C series has been designed in accordance with following safety standards. Appropriate safety certificates and approvals are available to download from our website www.powerconversion.com.

Table 6. Safety Certifications for ADN-C series power supply

Document	Description
UL508 Listed, cULus	Standard for Industrial Control Equipment
UL60950-1, cRUus	Safety of information Technology Equipment
IEC/EN60950-1	Safety of information Technology Equipment
ATEX Certification	Class 1, Division 2 hazardous location, Groups A, B, C, D w/ T3A temp class up to 40°C Ambient
CB Certificate and Report	(All CENELEC Countries)
CE Mark	LVD (73/23 & 2004/108/EC) EMC (89/336 & 93/68/EEC)
IEC536	Protection Class 1
IEC60529	IP20
IEC60950-1	SELV

Storage and Shipping Temperature / Humidity

The ADN-C series power supplies can be stored or shipped at temperatures between -40°C to +85°C and relative humidity from 0% to 95% non-condensing.

Altitude

The ADN-C series will operate within specifications at altitudes up to 10,000 feet above sea level.

Humidity

The ADN-C series will operate within specifications when subjected to a relative humidity from 5% to 95% non-condensing. The ADN-C series can be stored in a relative humidity from 0% to 95% non-condensing.

Vibration

The ADN-C power supply will pass the following vibration specifications:

Parameter	Model	Symbol	Min	Typ	Max	Unit
Vibration Operating	ADN5	Accordance to Vibration (Sinusoidal) per IEC 68-2-6 0.15 gravity (g) peak, 5–500 Hz (swept sine); 5–500 Hz (random); vertical axis only				
	ADN10	4.0 gravity (g) peak, 10–2000 Hz (random); 3 axes for 20 mins. each per IEC 60068-2-6				
	ADN20	15 gravity (g) peak, 5–500 Hz (swept sine); 5–500 Hz (random); vertical axis only				
	ADN40	Accordance to Vibration (Sinusoidal) per IEC 60068-2-6 0.21 gravity (g) peak, 5–500 Hz (swept sine); 5–500 Hz (random); vertical axis only				

Shock

The ADN-C power supply will pass the following shock specifications:

Parameter	Model	Symbol	Min	Typ	Max	Unit
Shock Operating	ADN5	Accordance to IEC 68-2-27 3g peak, 11 milliseconds half-sine pulse				
	ADN10	15g peak, 11 milliseconds per IEC 60068-2-6				
	ADN20	3g peak, 11 milliseconds half-sine pulse				
	ADN40	30g peak, 11 milliseconds half-sine pulse based on QP4205				

Application Notes

Output Ripple and Noise Measurement

The setup outlined in the diagram below has been used for output voltage ripple and noise measurements on the ADN Series. When measuring output ripple and noise, the scope is connected to the circuit via an RGU58-50Ω cable. One side is BNC and the other is soldered to the PCB. Shield is grounded. Oscilloscope should be set to 50Ω input with 20 MHz bandwidth for this measurement.

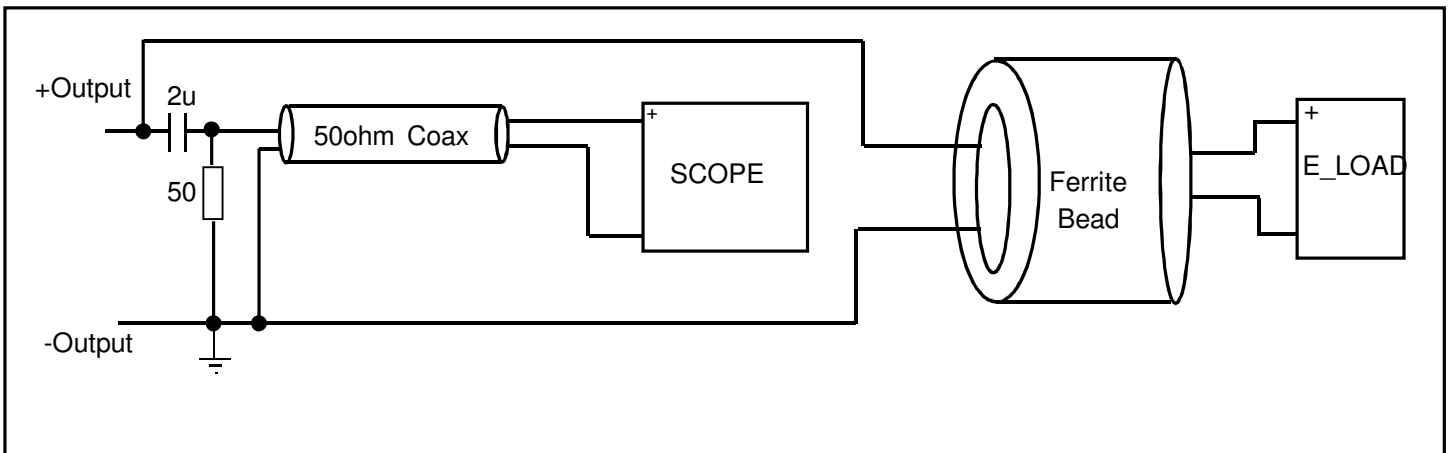

Common-Mode Noise

The setup outlined in the diagram below has been used for output voltage common-mode noise measurements on the ADN Series. The measurements are made individually (+) to GND or (-) to GND. The scope is connected to the circuit via an RGU58-50Ω cable. One side is BNC and the other is soldered to the PCB. Shield is grounded. Oscilloscope should be set to 50Ω input with 20 MHz bandwidth for this measurement.

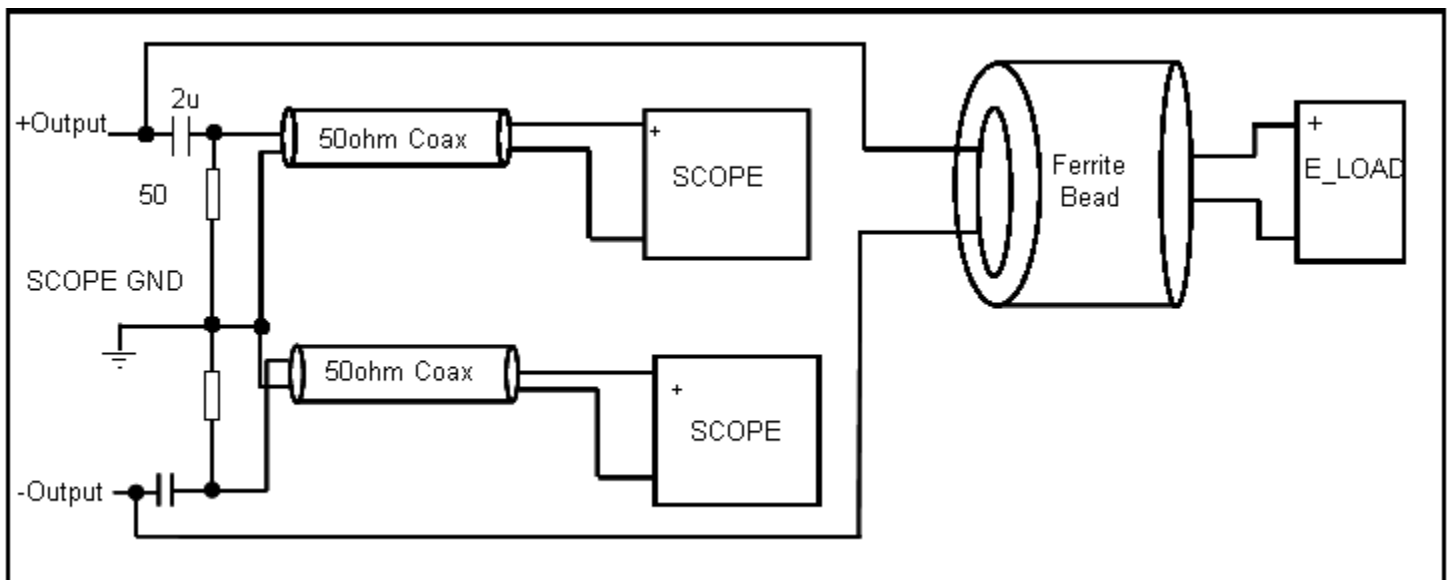

WORLDWIDE OFFICES

Americas

2900 S.Diablo Way
Tempe, AZ 85282
USA
+1 888 412 7832

Europe (UK)

Waterfront Business Park
Merry Hill, Dudley
West Midlands, DY5 1LX
United Kingdom
+44 (0) 1384 842 211

Asia (HK)

14/F, Lu Plaza
2 Wing Yip Street
Kwun Tong, Kowloon
Hong Kong
+852 2176 3333



www.artesyn.com

While every precaution has been taken to ensure accuracy and completeness in this literature, Artesyn Embedded Technologies assumes no responsibility, and disclaims all liability for damages resulting from use of this information or for any errors or omissions. Artesyn Embedded Technologies, Artesyn and the Artesyn Embedded Technologies logo are trademarks and service marks of Artesyn Technologies, Inc. All other names and logos referred to are trade names, trademarks, or registered trademarks of their respective owners.
© 2014 All rights reserved.

For more information: www.artesyn.com/power
For support: productsupport.ep@artesyn.com