

FAST RECOVERY DIODES

Stud Version

Features

- High power FAST recovery diode series
- 1.0 to 1.5 μ s recovery time
- High voltage ratings up to 1600V
- High current capability
- Optimized turn on and turn off characteristics
- Low forward recovery
- Fast and soft reverse recovery
- Compression bonded encapsulation
- Stud version JEDEC DO-30
- Maximum junction temperature 125°C
- RoHS Compliant

150A

Typical Applications

- Snubber diode for GTO
- High voltage free-wheeling diode
- Fast recovery rectifier applications

Major Ratings and Characteristics

Parameters	SD153N/R	Units
$I_{F(AV)}$	150	A
@ T_C	85	°C
$I_{F(RMS)}$	235	A
I_{FSM} @ 50Hz	4280	A
@ 60Hz	4480	A
I^2t @ 50Hz	92	KA ² s
@ 60Hz	84	KA ² s
V_{RRM} range	400 to 1600	V
t_{rr} range	1.0 to 1.5	μ s
@ T_J	25	°C
T_J	- 40 to 125	°C

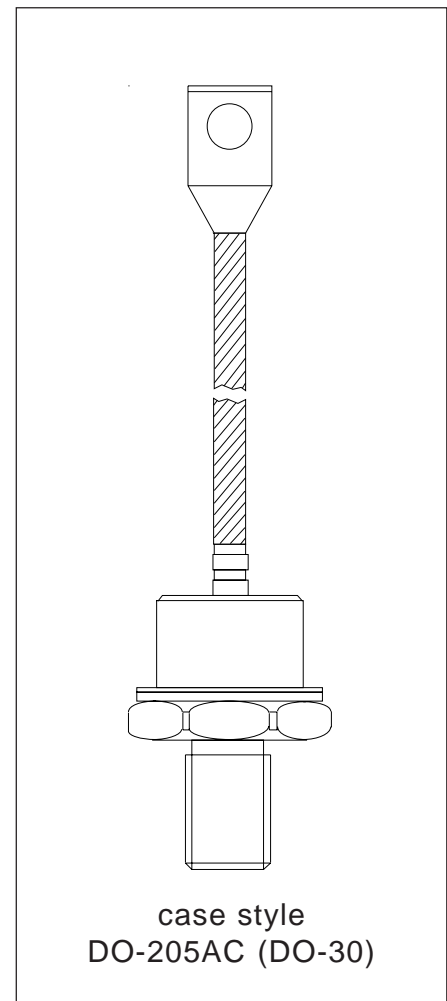

ELECTRICAL SPECIFICATIONS

Voltage Ratings

Type number	Voltage Code	V _{RRM} max. repetitive peak and off-state voltage V	V _{RSM} , maximum non-repetitive peak voltage V	I _{RRM} max. T _J = 125°C mA
SD153N/R..S10	04	400	500	35
	08	800	900	
	10	1000	1100	
SD153N/R..S15	12	1200	1300	
	14	1400	1500	
	16	1600	1700	

Forward Conduction

Parameter	SD153N/R	Units	Conditions
I _{F(AV)} Max. average forward current @ Case temperature	150	A	180° conduction, half sine wave.
	85	°C	
I _{F(RMS)} Max. RMS current	235	A	DC @ 74°C case temperature
I _{FSM} Max. peak, one-cycle non-repetitive forward current	4280	A	t = 10ms No voltage reappplied
	4480		t = 8.3ms reappplied
	3600		t = 10ms 100% V _{RRM} reappplied
	3770		t = 8.3ms reappplied
I ² t Maximum I ² t for fusing	92	KA ² s	t = 10ms No voltage reappplied
	84		t = 8.3ms reappplied
	65		t = 10ms 100% V _{RRM} reappplied
	59		t = 8.3ms reappplied
I ² √t Maximum I ² √t for fusing	916	KA ² √s	t = 0.1 to 10ms, no voltage reappplied
V _{F(TO)1} Low level of threshold voltage	1.00	V	(16.7% × π × I _{F(AV)} < I < π × I _{F(AV)}), T _J = T _J max.
V _{F(TO)2} High level of threshold voltage	1.46		(I > π × I _{F(AV)}), T _J = T _J max.
r _{f1} Low level of forward slope resistance	1.35	mΩ	(16.7% × π × I _{F(AV)} < I < π × I _{F(AV)}), T _J = T _J max.
r _{f2} High level of forward slope resistance	0.52		(I > π × I _{F(AV)}), T _J = T _J max.
V _{FM} Max. forward voltage	1.55	V	I _{pk} = 470 A, T _J = 25°C, t _p = 400 μs square pulse

Recovery Characteristics

Code	T _J = 25°C typical t _{rr} @ 25% I _{RRM} (μs)	Testconditions			Max. values @ T _J = 125°C			
		I _{pk} Square Pulse (A)	di/dt (A/μs)	V _r (V)	t _{rr} @ 25% I _{RRM} (μs)	Q _{rr} (μC)	I _{rr} (A)	
S10	1.0	350	25	-30	1.6	21	27	
S15	1.5				2.3	61	37	

Thermal and Mechanical Specification

Parameter	SD153N/R	Units	Conditions
T _J Max. operating temperature range	-40 to 125	°C	
T _{stg} Max. storage temperature range	-40 to 150		
R _{thJC} Max. thermal resistance, junction to case	0.16	K/W	DC operation
R _{thCS} Max. thermal resistance, case to heatsink	0.10		Mounting surface, smooth, flat and greased
T Mounting torque ± 10%	15.5	N m	Not lubricated threads
	13.5		Lubricated threads
wt Approximate weight	120	g	
Case style	DO-205AC (DO-30)		See Outline Table

ΔR_{thJC} Conduction

(The following table shows the increment of thermal resistance R_{thJC} when devices operate at different conduction angles than DC)

Conduction angle	Sinusoidal conduction	Rectangular conduction	Units	Conditions
180°	0.011	0.012	K/W	T _J = T _J max.
120°	0.016	0.019		
90°	0.021	0.023		
60°	0.029	0.030		
30°	0.041	0.041		

Ordering Information Table

Device Code

SD	15	3	R	16	S15	P	B	V
①	②	③	④	⑤	⑥	⑦	⑧	⑨

- 1** - Diode
- 2** - Essential part number
- 3** - 3 = Fast recovery
- 4** - N = Stud Normal Polarity (Cathode to Stud)
R = Stud Reverse Polarity (Anode to Stud)
- 5** - Voltage code: Code x 100 = V_{RRM} (see Voltage Ratings table)
- 6** - t_{rr} code (see Recovery Characteristics table)
- 7** - P = Stud base DO-205AC (DO-30) 1/2" 20UNF-2A
M = Stud base DO-205AC (DO-30) M12 X 1.75
- 8** - B = Flag top terminals (for Cathode/ Anode Leads)
S = Isolated lead with silicone sleeve
(Red = Reverse Polarity; Blue = Normal Polarity)
None = Not isolated lead
- 9** - V = Glass-metal seal

Outline Table

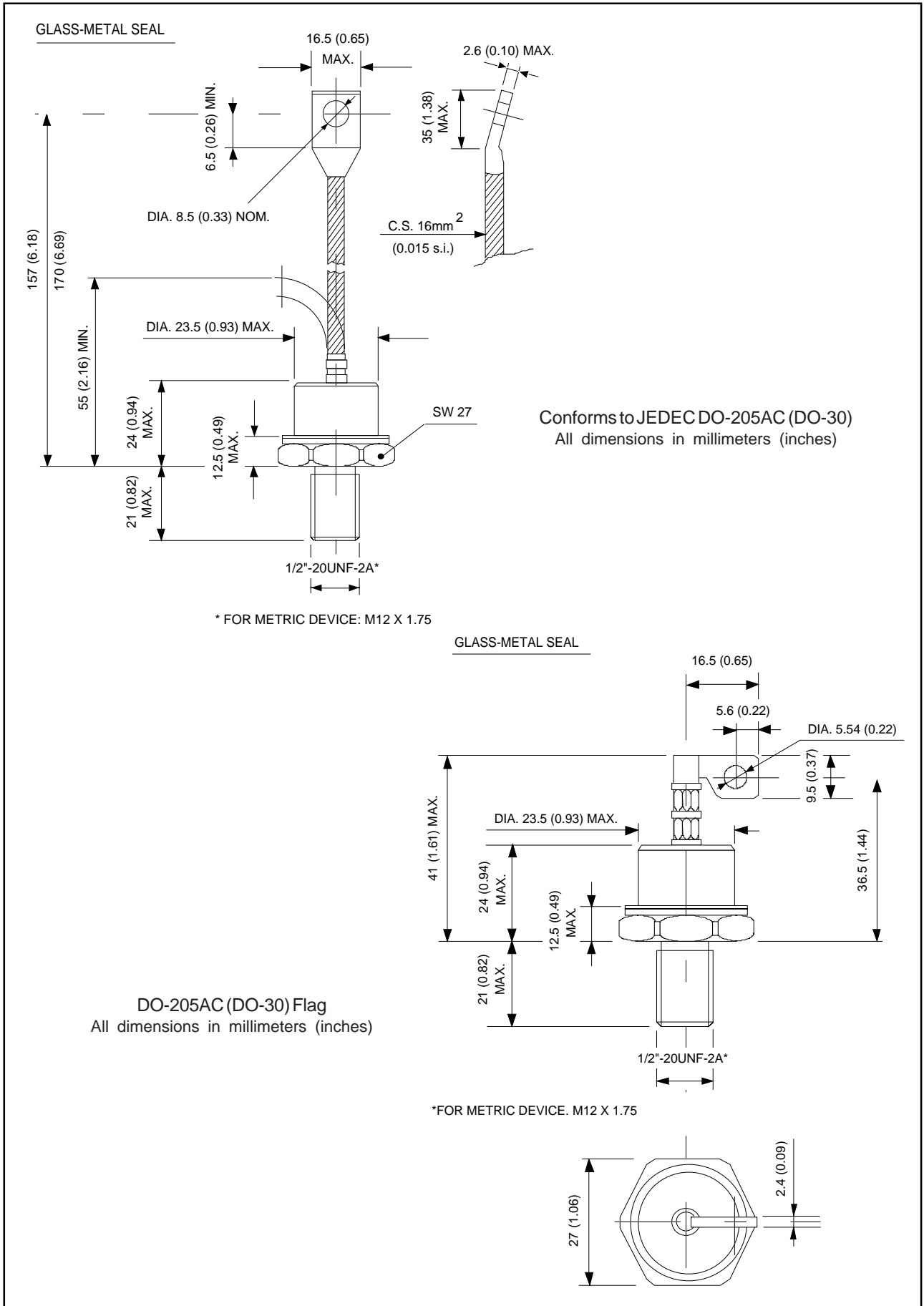

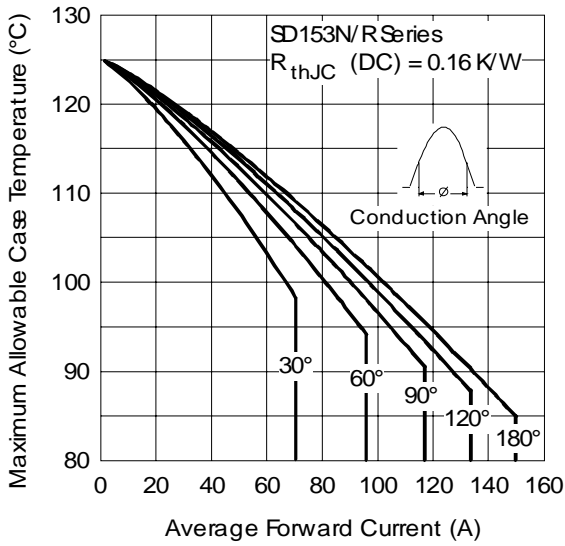

Fig. 1 - Current Ratings Characteristics

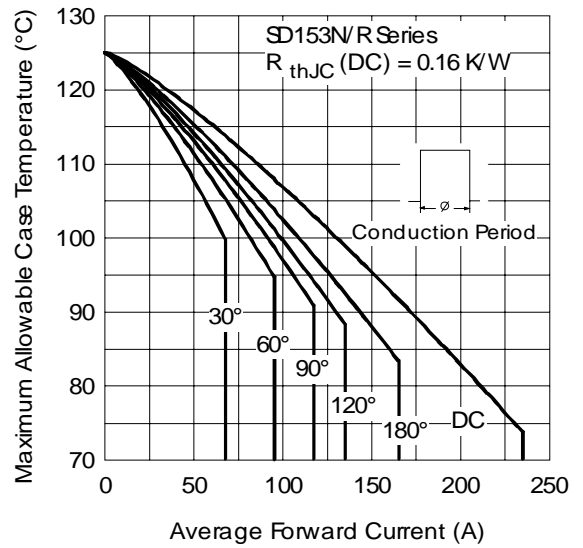

Fig. 2 - Current Ratings Characteristics

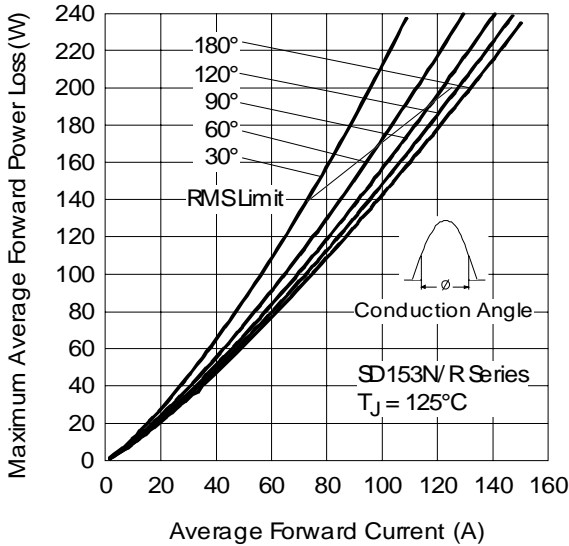

Fig. 3 - Forward Power Loss Characteristics

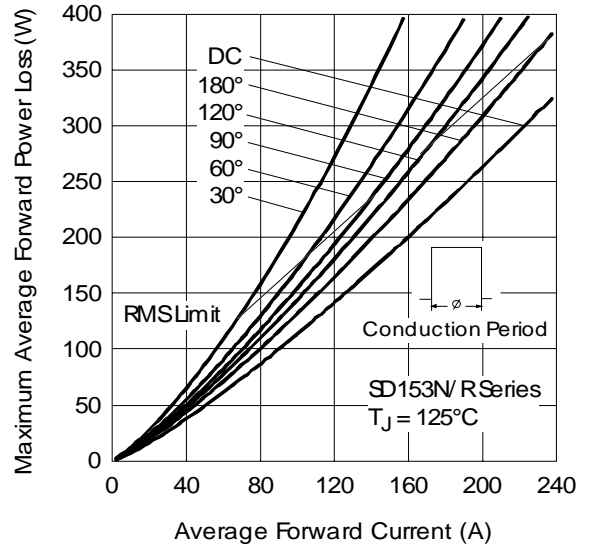

Fig. 4 - Forward Power Loss Characteristics

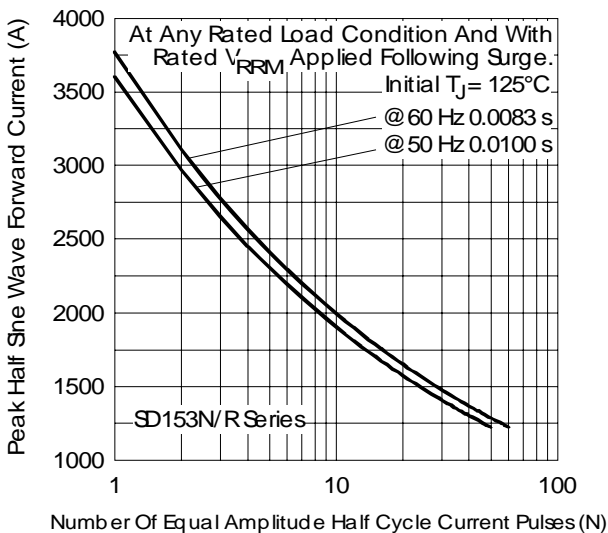

Fig. 5 - Maximum Non-repetitive Surge Current

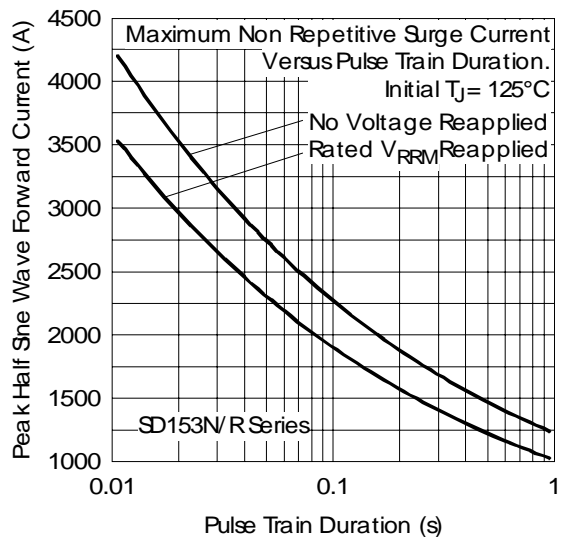

Fig. 6 - Maximum Non-repetitive Surge Current

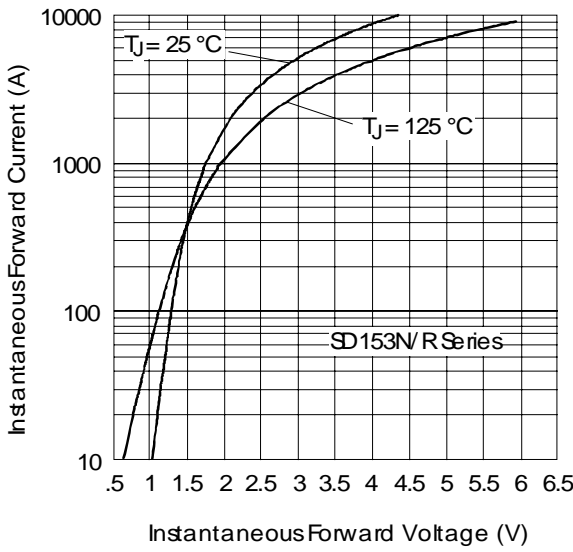

Fig. 7 - Forward Voltage Drop Characteristics

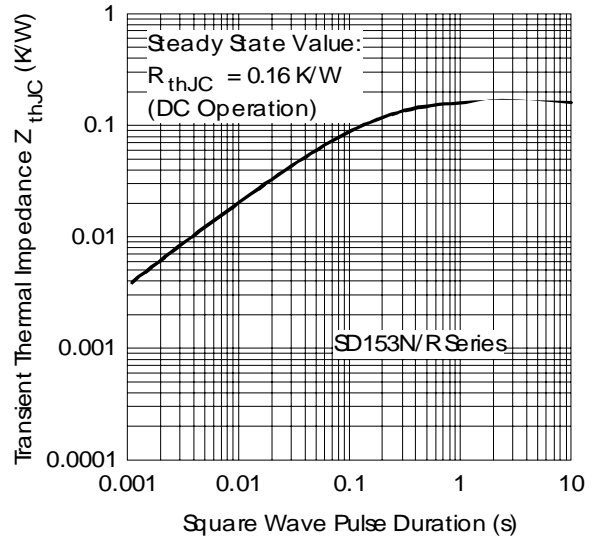

Fig. 8 - Thermal Impedance Z_{thJC} Characteristic

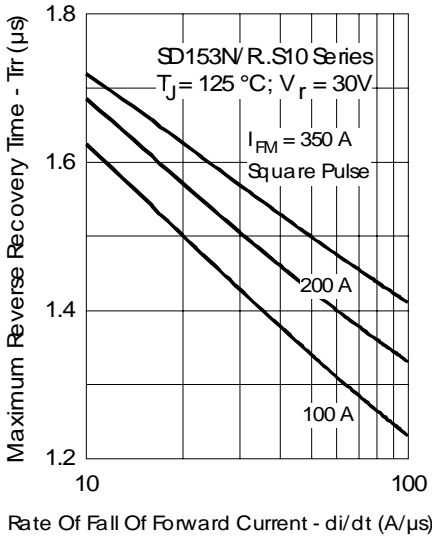

Fig. 9 - Recovery Time Characteristics

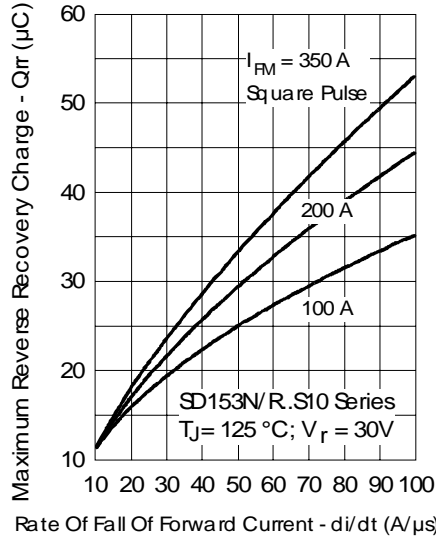

Fig. 10 - Recovery Charge Characteristics

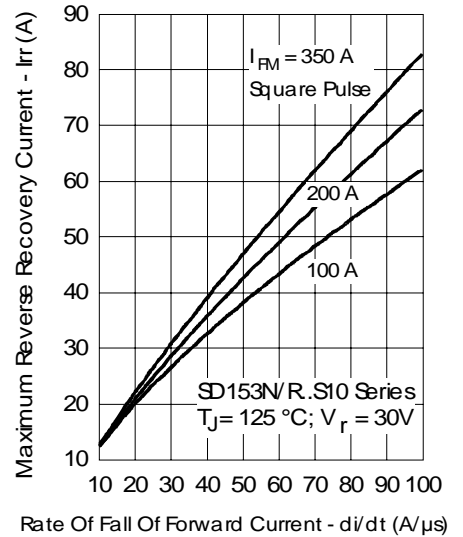

Fig. 11 - Recovery Current Characteristics

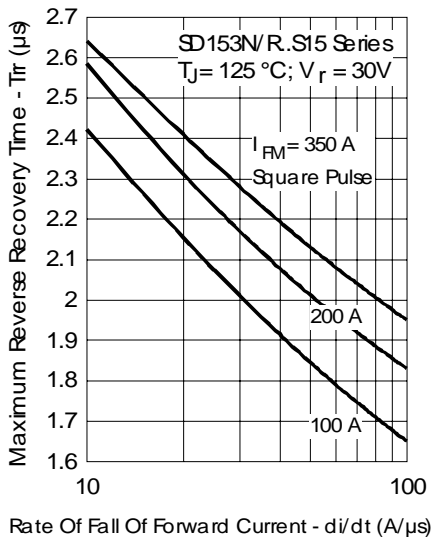

Fig. 12 - Recovery Time Characteristics

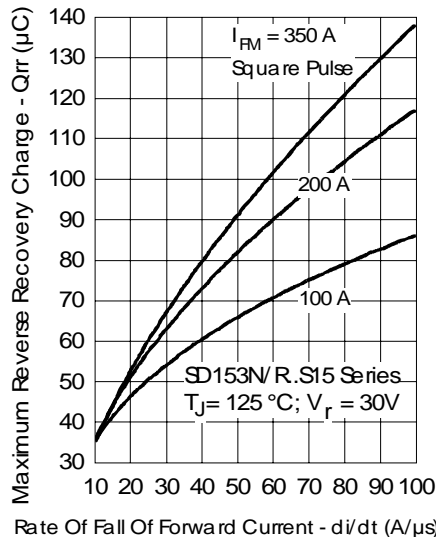

Fig. 13 - Recovery Charge Characteristics

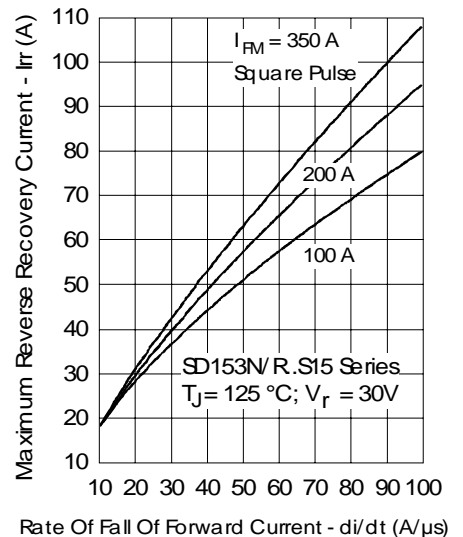

Fig. 14 - Recovery Current Characteristics

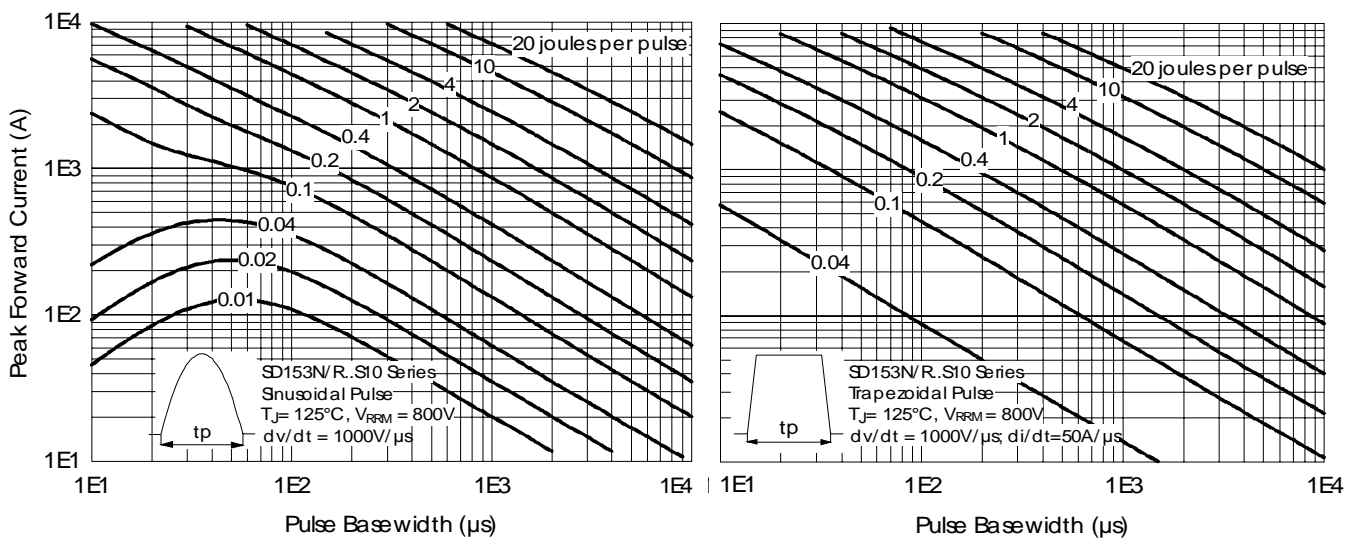

Fig. 15 - Maximum Total Energy Loss Per Pulse Characteristics

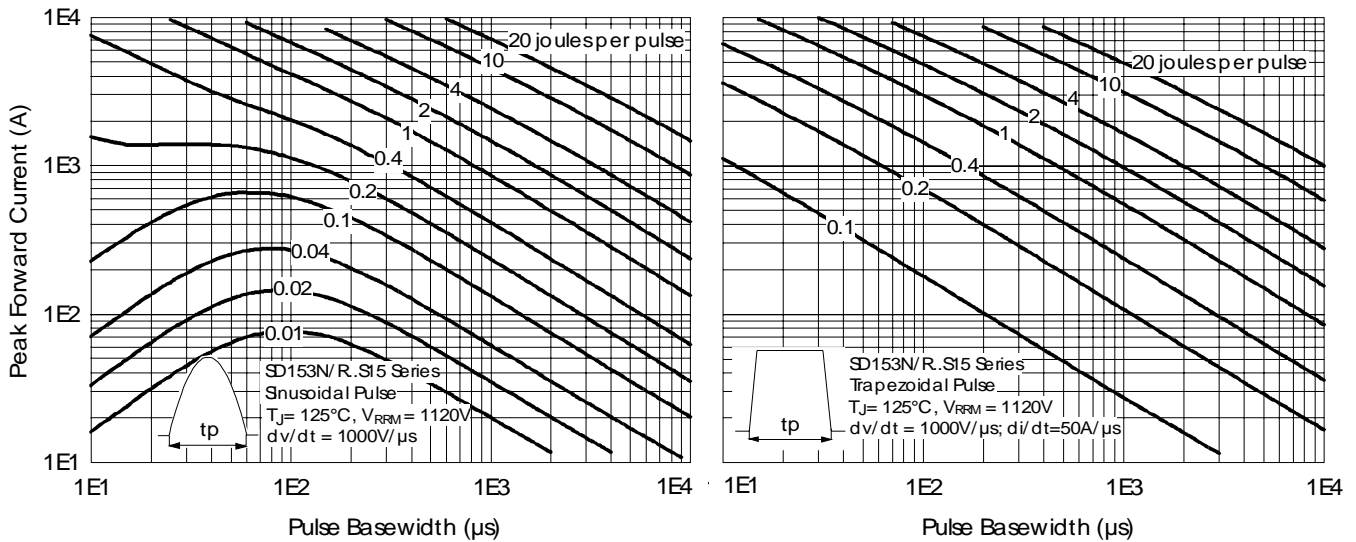

Fig. 16 - Maximum Total Energy Loss Per Pulse Characteristics

Data and specifications subject to change without notice.
This product has been designed and qualified for Industrial Level.
Qualification Standards can be found on IR's Web site.