

One Watt Darlington Transistors

PNP Silicon

MPSW63 MPSW64*

*ON Semiconductor Preferred Device

- These devices are available in Pb-free package(s). Specifications herein apply to both standard and Pb-free devices. Please see our website at www.onsemi.com for specific Pb-free orderable part numbers, or contact your local ON Semiconductor sales office or representative.

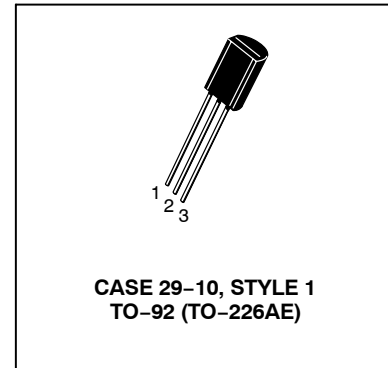

MAXIMUM RATINGS

Rating	Symbol	MPSW63 MPSW64	Unit
Collector – Emitter Voltage	V_{CES}	-30	Vdc
Collector – Base Voltage	V_{CBO}	-30	Vdc
Emitter – Base Voltage	V_{EBO}	-10	Vdc
Collector Current — Continuous	I_C	-500	mAdc
Total Device Dissipation @ $T_A = 25^\circ\text{C}$ Derate above 25°C	P_D	1.0 8.0	Watt mW/ $^\circ\text{C}$
Total Device Dissipation @ $T_C = 25^\circ\text{C}$ Derate above 25°C	P_D	2.5 20	Watts mW/ $^\circ\text{C}$
Operating and Storage Junction Temperature Range	T_J, T_{stg}	-55 to +150	$^\circ\text{C}$

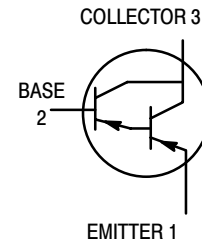

THERMAL CHARACTERISTICS

Characteristic	Symbol	Max	Unit
Thermal Resistance, Junction to Ambient	$R_{\theta JA}$	125	$^\circ\text{C}/\text{W}$
Thermal Resistance, Junction to Case	$R_{\theta JC}$	50	$^\circ\text{C}/\text{W}$

ELECTRICAL CHARACTERISTICS ($T_A = 25^\circ\text{C}$ unless otherwise noted)

Characteristic	Symbol	Min	Max	Unit
----------------	--------	-----	-----	------

OFF CHARACTERISTICS

Collector – Emitter Breakdown Voltage ($I_C = -100 \mu\text{Adc}, V_{BE} = 0$)	$V_{(BR)CES}$	-30	—	Vdc
Collector Cutoff Current ($V_{CB} = -30 \text{Vdc}, I_E = 0$)	I_{CBO}	—	-100	nAdc
Emitter Cutoff Current ($V_{EB} = -10 \text{Vdc}, I_C = 0$)	I_{EBO}	—	-100	nAdc

Preferred devices are ON Semiconductor recommended choices for future use and best overall value.

MPSW63 MPSW64

ELECTRICAL CHARACTERISTICS ($T_A = 25^\circ\text{C}$ unless otherwise noted) (Continued)

Characteristic	Symbol	Min	Max	Unit
ON CHARACTERISTICS⁽¹⁾				
DC Current Gain ($I_C = -10\text{ mAdc}$, $V_{CE} = -5.0\text{ Vdc}$)	h_{FE}	5,000	—	—
	MPSW63 MPSW64	10,000	—	—
DC Current Gain ($I_C = -100\text{ mAdc}$, $V_{CE} = -5.0\text{ Vdc}$)	h_{FE}	10,000	—	—
	MPSW63 MPSW64	20,000	—	—
Collector–Emitter Saturation Voltage ($I_C = -100\text{ mAdc}$, $I_B = -0.1\text{ mAdc}$)	$V_{CE(sat)}$	—	-1.5	Vdc
Base–Emitter On Voltage ($I_C = -100\text{ mAdc}$, $V_{CE} = -5.0\text{ Vdc}$)	$V_{BE(on)}$	—	-2.0	Vdc

SMALL-SIGNAL CHARACTERISTICS

Current–Gain — Bandwidth Product ⁽²⁾ ($I_C = -10\text{ mAdc}$, $V_{CE} = -5.0\text{ Vdc}$, $f = 100\text{ MHz}$)	f_T	125	—	MHz
--	-------	-----	---	-----

1. Pulse Test: Pulse Width $\leq 300\ \mu\text{s}$, Duty Cycle $\leq 2.0\%$.
2. $f_T = |h_{fe}| \cdot f_{test}$.

TYPICAL ELECTRICAL CHARACTERISTICS

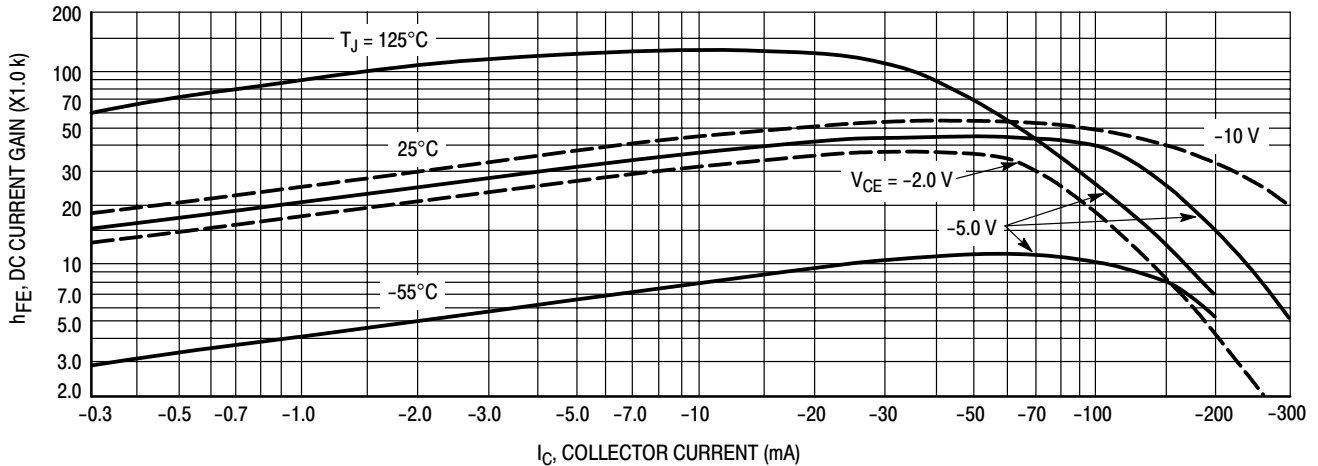

Figure 1. DC Current Gain

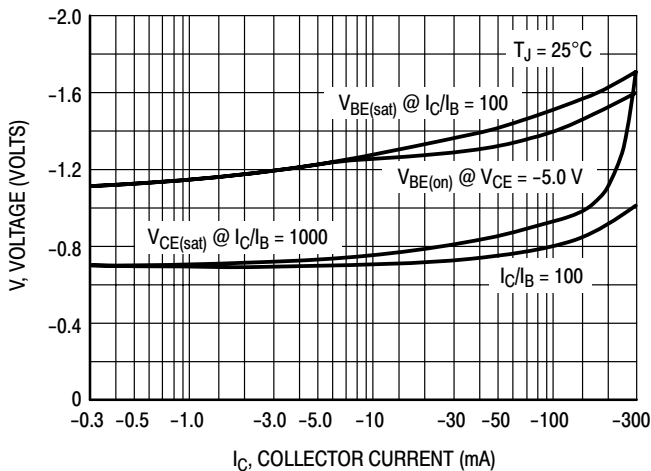

Figure 2. "ON" Voltage

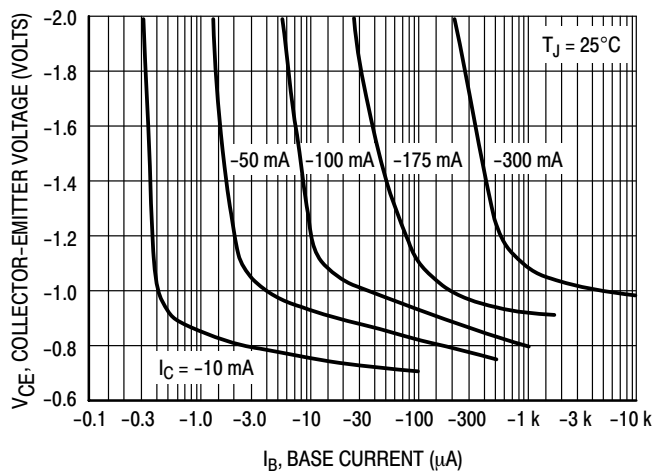

Figure 3. Collector Saturation Region

MPSW63 MPSW64

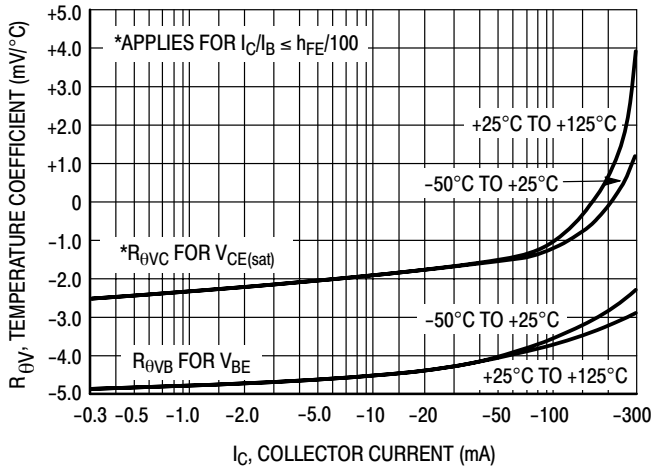

Figure 4. Temperature Coefficients

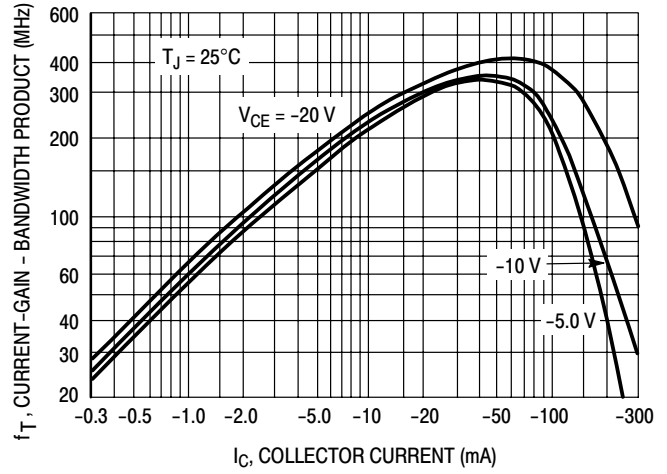

Figure 5. Current-Gain — Bandwidth Product

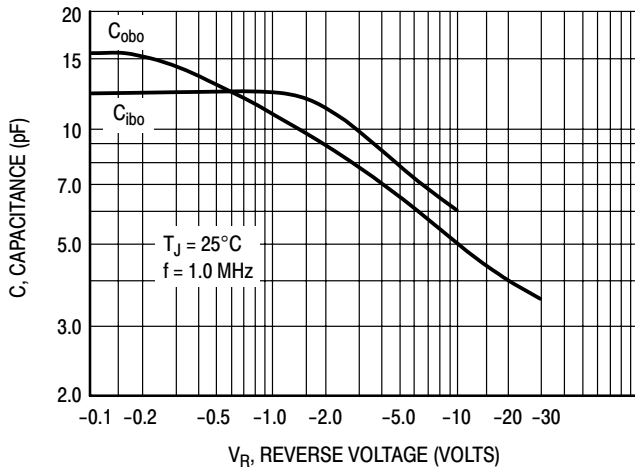

Figure 6. Capacitance

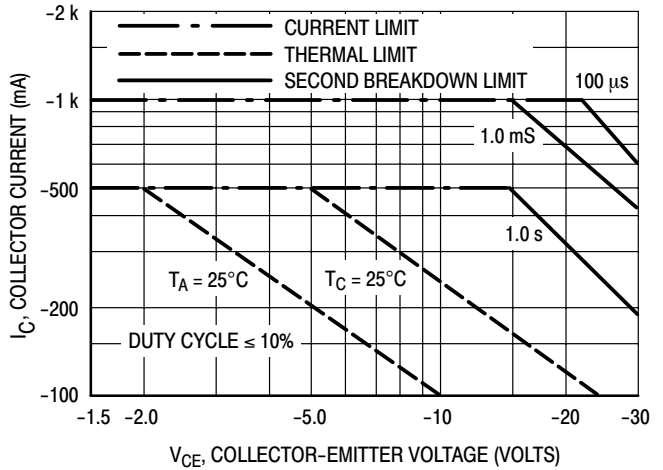
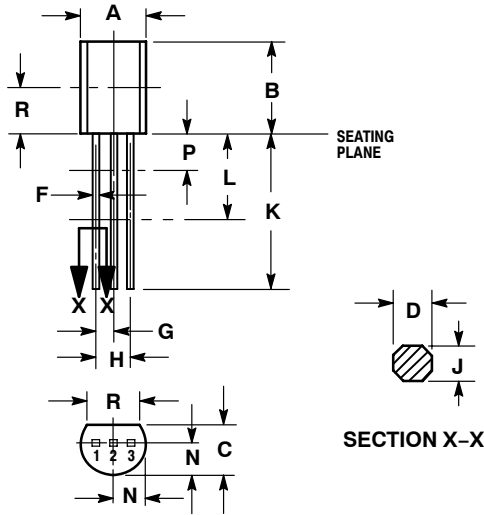

Figure 7. Active Region, Safe Operating Area

MPSW63 MPSW64

PACKAGE DIMENSIONS

TO-92 (TO-226) CASE 29-10 ISSUE AL



NOTES:

1. DIMENSIONING AND TOLERANCING PER ANSI Y14.5M, 1982.
2. CONTROLLING DIMENSION: INCH.
3. CONTOUR OF PACKAGE BEYOND DIMENSION R IS UNCONTROLLED.
4. DIMENSION F APPLIES BETWEEN P AND L. DIMENSIONS D AND J APPLY BETWEEN L AND K MINIMUM. LEAD DIMENSION IS UNCONTROLLED IN P AND BEYOND DIMENSION K MINIMUM.

DIM	INCHES		MILLIMETERS	
	MIN	MAX	MIN	MAX
A	0.175	0.205	4.44	5.21
B	0.290	0.310	7.37	7.87
C	0.125	0.165	3.18	4.19
D	0.018	0.021	0.457	0.533
F	0.016	0.019	0.407	0.482
G	0.045	0.055	1.15	1.39
H	0.095	0.105	2.42	2.66
J	0.018	0.024	0.46	0.61
K	0.500	---	12.70	---
L	0.250	---	6.35	---
N	0.080	0.105	2.04	2.66
P	---	0.100	---	2.54
R	0.135	---	3.43	---

TYPE 1:

1. EMITTER
2. BASE
3. COLLECTOR

ON Semiconductor and are registered trademarks of Semiconductor Components Industries, LLC (SCILLC). SCILLC reserves the right to make changes without further notice to any products herein. SCILLC makes no warranty, representation or guarantee regarding the suitability of its products for any particular purpose, nor does SCILLC assume any liability arising out of the application or use of any product or circuit, and specifically disclaims any and all liability, including without limitation special, consequential or incidental damages. "Typical" parameters which may be provided in SCILLC data sheets and/or specifications can and do vary in different applications and actual performance may vary over time. All operating parameters, including "Typicals" must be validated for each customer application by customer's technical experts. SCILLC does not convey any license under its patent rights nor the rights of others. SCILLC products are not designed, intended, or authorized for use as components in systems intended for surgical implant into the body, or other applications intended to support or sustain life, or for any other application in which the failure of the SCILLC product could create a situation where personal injury or death may occur. Should Buyer purchase or use SCILLC products for any such unintended or unauthorized application, Buyer shall indemnify and hold SCILLC and its officers, employees, subsidiaries, affiliates, and distributors harmless against all claims, costs, damages, and expenses, and reasonable attorney fees arising out of, directly or indirectly, any claim of personal injury or death associated with such unintended or unauthorized use, even if such claim alleges that SCILLC was negligent regarding the design or manufacture of the part. SCILLC is an Equal Opportunity/Affirmative Action Employer. This literature is subject to all applicable copyright laws and is not for resale in any manner.

PUBLICATION ORDERING INFORMATION

LITERATURE FULFILLMENT:

Literature Distribution Center for ON Semiconductor
P.O. Box 61312, Phoenix, Arizona 85082-1312 USA
Phone: 480-829-7710 or 800-344-3860 Toll Free USA/Canada
Fax: 480-829-7709 or 800-344-3867 Toll Free USA/Canada
Email: orderlit@onsemi.com

N. American Technical Support: 800-282-9855 Toll Free
USA/Canada

Japan: ON Semiconductor, Japan Customer Focus Center
2-9-1 Kamimeguro, Meguro-ku, Tokyo, Japan 153-0051
Phone: 81-3-5773-3850

ON Semiconductor Website: <http://onsemi.com>

Order Literature: <http://www.onsemi.com/litorder>

For additional information, please contact your
local Sales Representative.