

DIN RECEPTACLES

MINI-DIN RIGHT-ANGLE RECEPTACLES

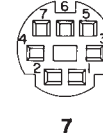

CONTACT ARRANGEMENTS
(viewed from contact side)

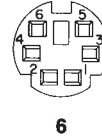
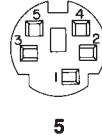
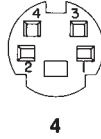
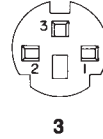

DIMENSIONAL DRAWINGS

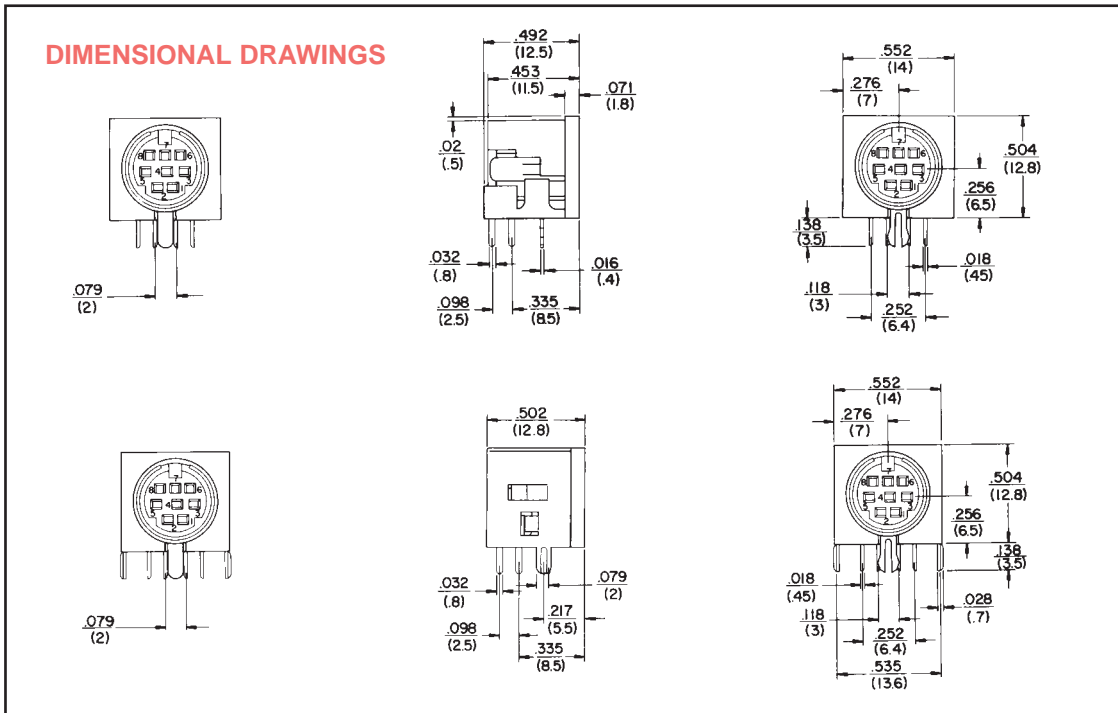

RECOMMENDED PC BOARD LAYOUTS (VIEWED FROM COMPONENT SIDE)

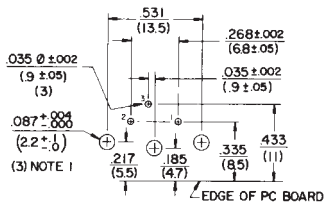

NOTE: 2 OUTSIDE HOLES NOT USED ON SMD3FRAX10 & SMD3FRAX20

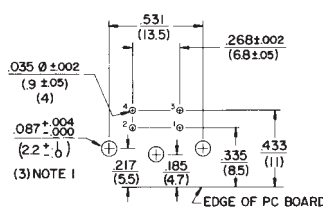

NOTE: 2 OUTSIDE HOLES NOT USED ON SMD4FRAX10 & SMD4FRAX20

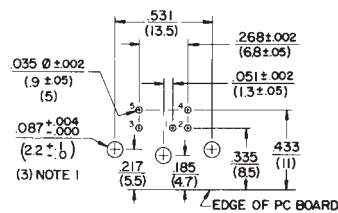

NOTE 1: 2 OUTSIDE HOLES NOT USED ON SMD5FRAX10 & SMD5FRAX20

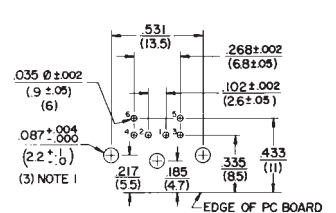

NOTE: 2 OUTSIDE HOLES NOT USED ON SMD6FRAX10 & SMD6FRAX20

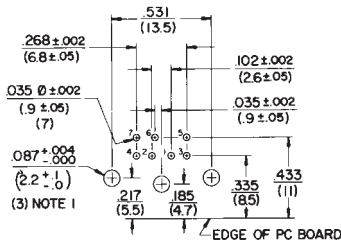

NOTE: 2 OUTSIDE HOLES NOT USED ON SMD7FRAX10 & SMD7FRAX20

DIMENSIONS ARE FOR REFERENCE ONLY
Inch (mm)

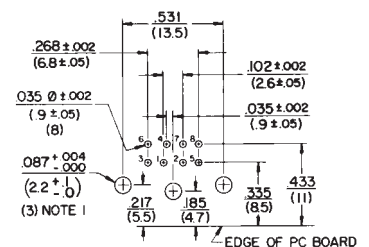

NOTE 1: 2 OUTSIDE HOLES NOT USED ON SMD8FRAX10 & SMD8FRAX20

NOTE: Contact your Switchcraft Representative for price and delivery.