

LQH3NPN680NG0#

"#" indicates a package specification code.



< List of part numbers with package codes >
 LQH3NPN680NG0L , LQH3NPN680NG0K

Shape

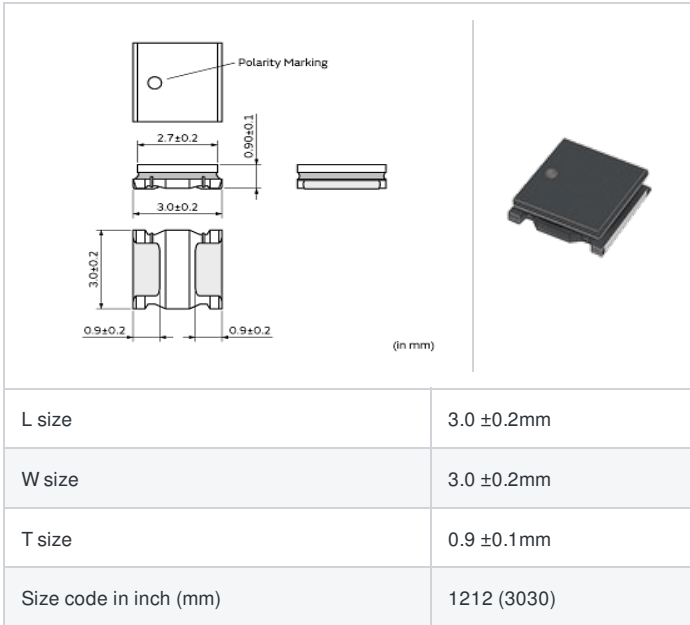

Notes

When applied Rated current to the Products, Inductance will be within ±30% of nominal Inductance value.
 When applied Rated current to the Products, temperature rise caused by self-generated heat shall be limited to 40°C max.
 Keep the temperature (ambient temperature plus self-generation of heat) under 125°C.

References

Packaging code	Specifications	Minimum quantity
L	φ180mm Embossed taping	1500
K	φ330mm Embossed taping	6000

Mass (Typ.)	
1 piece	0.034g

Specifications

Inductance	68μH ±30%
Inductance test frequency	1MHz
Rated current (I _{sat}) (Based on Inductance change)	150mA
Rated current (I _{temp}) (Based on Temperature rise)	235mA
Max. of DC resistance	5.04Ω
Avg. of DC resistance	4.2Ω±20%
Self resonance frequency (min.)	16MHz
Operating temperature range (Self-temperature rise is not included)	-40~85°C
Class of magnetic shield	Magnetic Resin
Series	LQH3NPN_G0

Attention

- 1.This datasheet is downloaded from the website of Murata Manufacturing Co., Ltd. Therefore, it's specifications are subject to change or our products in it may be discontinued without advance notice. Please check with our sales representatives or product engineers before ordering.
- 2.This datasheet has only typical specifications because there is no space for detailed specifications. Therefore, please review our product specifications or consult the approval sheet for product specifications before ordering.

Chart of characteristic data (The charts below may show another part number which shares its characteristics.)

■ Inductance-Frequency characteristics (Typ.)

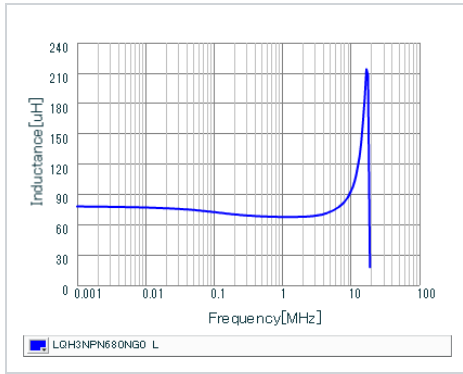

■ Inductance-Current characteristics (Typ.)

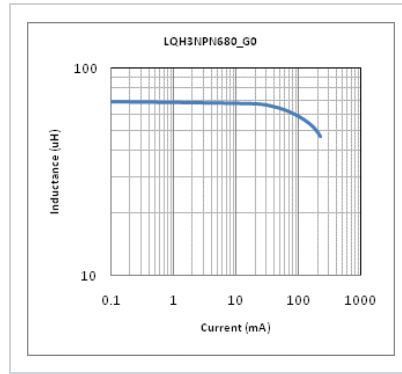

■ Temperature rise characteristics (Typ.)

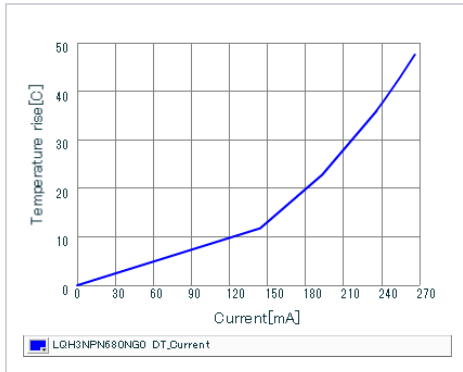

⚠ Attention

- 1.This datasheet is downloaded from the website of Murata Manufacturing Co., Ltd. Therefore, it's specifications are subject to change or our products in it may be discontinued without advance notice. Please check with our sales representatives or product engineers before ordering.
- 2.This datasheet has only typical specifications because there is no space for detailed specifications. Therefore, please review our product specifications or consult the approval sheet for product specifications before ordering.