

PRODUCT NO.

JSC96357

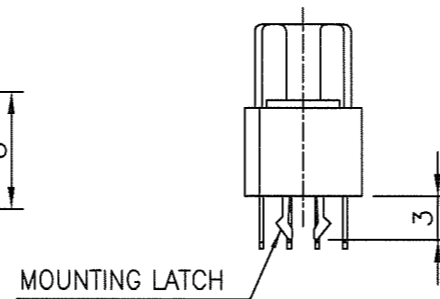

MOUNTING LATCH
PHEC___R-S111

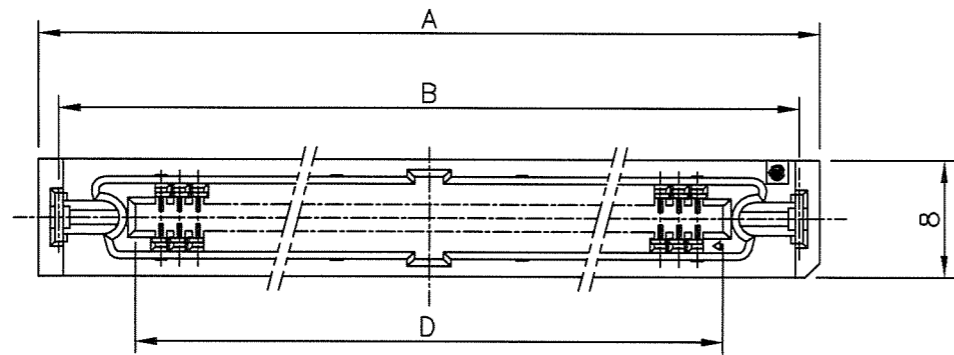
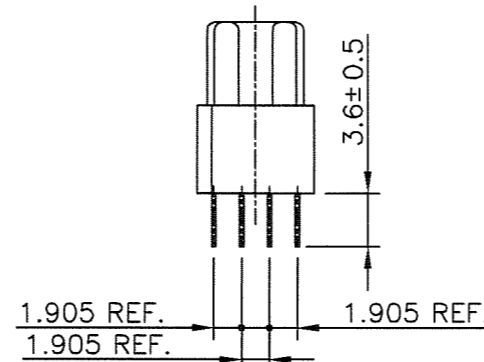
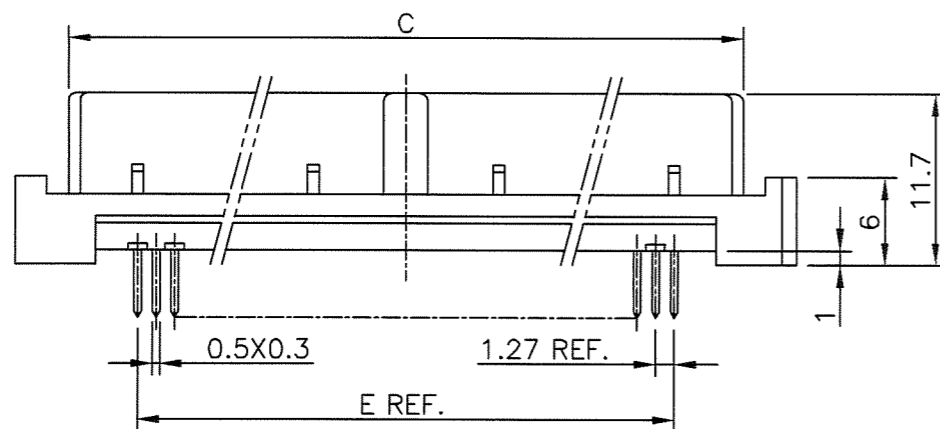

PHEC___R-S110

NO. OF CONTACTS : 40,60,68,80,100,120

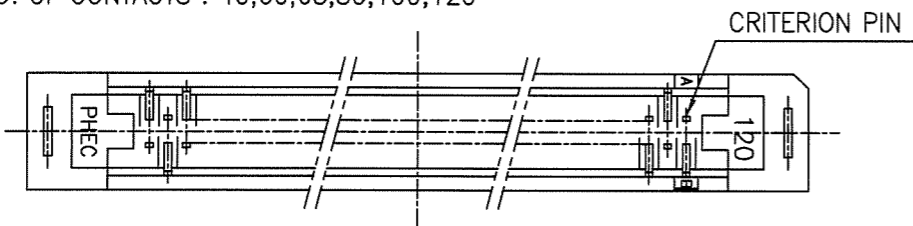

NO. OF CONTACTS : 30,34,50

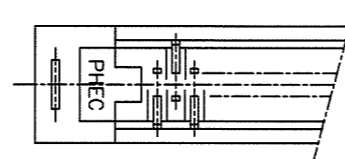

RECOMMENDED PC BOARD

THICKNESS : 1.6 ±0.2
HOLE PATTERN (COMPONENT SIDE)

NO. OF CONTACTS : 40,60,68,80,100,120 (n : NO. OF CONTACTS)

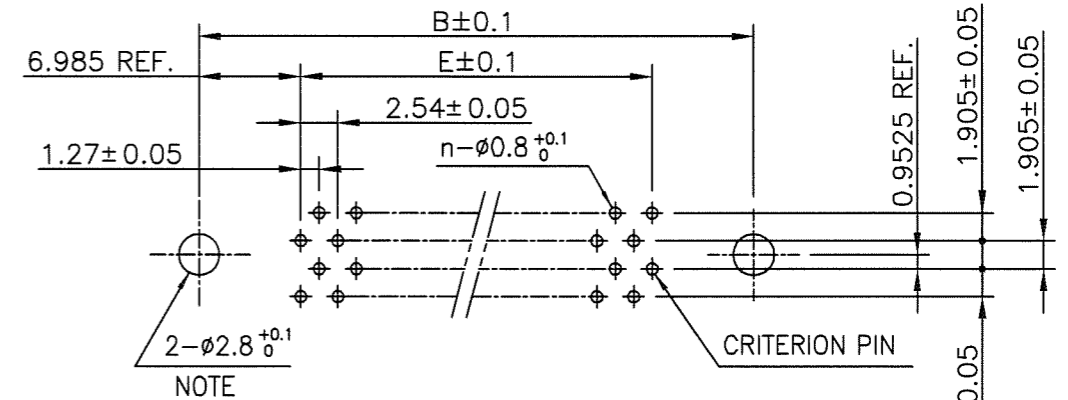

NO. OF CONTACTS : 30,34,50

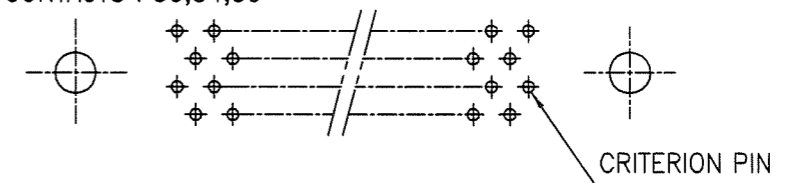

NOTE : THROUGH-HOLES FOR MOUNTING LATCHES ALSO SHOULD BE PLATED.

CAT. NO.	NO. OF CONTACTS (MATING SIDE)	DIMENSIONS				
		A	B	C	D	E
PHEC30R-S11_LF	15/ROW X 2 ROWS	34.55	31.75	27.26	21.26	17.78
PHEC34R-S11_LF	17/ROW X 2 ROWS	37.09	34.29	29.80	23.80	20.32
PHEC40R-S11_LF	20/ROW X 2 ROWS	40.90	38.10	33.61	27.61	24.13
PHEC50R-S11_LF	25/ROW X 2 ROWS	47.25	44.45	39.96	33.96	30.48
PHEC60R-S11_LF	30/ROW X 2 ROWS	53.60	50.80	46.31	40.31	36.83
PHEC68R-S11_LF	34/ROW X 2 ROWS	58.68	55.88	51.39	45.39	41.91
PHEC80R-S11_LF	40/ROW X 2 ROWS	66.30	63.50	59.01	53.01	49.53
PHEC100R-S11_LF	50/ROW X 2 ROWS	79.00	76.20	71.71	65.71	62.23
PHEC120R-S11_LF	60/ROW X 2 ROWS	91.70	88.90	84.41	78.41	74.93

NOTES

- BODY MATERIAL : PBT GLASS FILLED (UL94V-0), COLOR BLACK
- TERMINAL MATERIAL : PHOSPHOR BRONZE
- MOUNTING LATCH MATERIAL : PHOSPHOR BRONZE
- TERMINAL FINISH
CONTACT AREA : GOLD FLASH 0.1µm min. OVER NICKEL UNDERLAYER
SOLDER TAILS : PURE Sn 2µm min. OVER NICKEL UNDERLAYER
- MOUNTING LATCH FINISH : PURE Sn 2µm min. OVER NICKEL UNDERLAYER
- THIS PRODUCT MEETS EUROPEAN UNION DIRECTIVES AND OTHER COUNTRY REGULATIONS AS DESCRIBED IN GS-22-008
- THE HOUSING WILL WITHSTAND EXPOSURE TO 260 DEGREE PEAK TEMPERATURE FOR 10 SECONDS IN A WAVE SOLDER APPLICATION WITH A 1.6mm MINIMUM THICK CIRCUIT BOARD.

mat'l. code ---				surface ISO 1302 ✓	tolerance ISO 406 ISO 1101	projection	product family PHEC	CODE JP
ltr	description	ecn no	dr	date	tolerances unless otherwise specified		MM	title PRINTED CIRCUIT CONNECTOR (CAT.NO.PHEC ___ R-S11_LF)
A	RELEASED	J05-0186	S.O	3/29/'05	angles	linear		
B	REVISED	J07-0047	S.O	1/25/'07	0.X ±0.3	0.XX ±0.3		
C	REVISED	J07-0458	S.O	9/11/'07	0'±2'	0.XXX ±0.3	scale N/A	sheet 1 of 1 size JSC96357 A3 type Customer Drawing
				dr	S.OKUDAIRA	3/29/'05	FCJ	
				enr	S.OKUDAIRA	9/11/'07		
				chr	R. Showji	9/11/'07		
				appd	S. Okudaira	9/11/'07		
sheet index	revision sheet	C	1					Rev. C