

Automotive Grade AC Line Rated Ceramic Disc Capacitors Class X1, 440 V_{AC}, Class Y2, 300 V_{AC}


FEATURES

- AEC-Q200 qualified
- Withstands 85 / 85 / 1000 h test
- Can pass 3000 temperature cycles (from -55 °C to +125 °C)
- Complying with IEC 60384-14 4th edition
- High reliability
- Vertical (inline) kinked or straight leads
- Singlelayer AC disc safety capacitors
- PPAP (AIAG version) is available
- Material categorization: for definitions of compliance please see www.vishay.com/doc?99912



QUICK REFERENCE DATA				
DESCRIPTION	VALUE			
Ceramic Class	1		2	
Ceramic Dielectric	U2J	U2J	Y5S, Y5U	Y5S, Y5U
Voltage (V _{AC})	300	440	300	440
Min. Capacitance (pF)	10		68	
Max. Capacitance (pF)	47		4700	
Mounting	Radial			

OPERATING TEMPERATURE RANGE

-55 °C to +125 °C

TEMPERATURE CHARACTERISTICS

Class 1: N750 (U2J)

Class 2: Y5S, Y5U

SECTIONAL SPECIFICATIONS

Climatic category (according to EN 60058-1)

Class 1 and class 2: 40/125/21

COATING

According to UL 94 V-0

Epoxy resin, isolating, flame retardant

APPROVALS

IEC 60384-14.4

UL 60384-14

DIN EN 60384-14

CSA E60384-1:03, CSA E60384-14:09

PACKAGING

Bulk, tape and reel, taped ammpack

APPLICATIONS

- X1, Y2 according to IEC 60384-14.4
- Application as Y capacitors for AC line filter and primary-secondary coupling on battery chargers for PHEV/EV
- Application as filter capacitors on DC/DC converters for PHEV/EV and HEV

DESIGN

The capacitor consists of a ceramic disc which is silver plated on both sides. Connection leads are made of tin plated copper-clad steel having a diameter of 0.6 mm.

The capacitors may be supplied with straight or kinked leads having a lead spacing of 5 mm, 7.5 mm, or 10.0 mm. Encapsulation is made of flame retardant epoxy resin in accordance with UL 94 V-0.

CAPACITANCE RANGE

10 pF to 4700 pF

RATED VOLTAGE U_R

IEC 60384-14.4:

 (X1): 440 V_{AC}, 50 Hz

 (Y2): 300 V_{AC}, 50 Hz

TEST VOLTAGE

Component test (100 %):

 2600 V_{AC}, 50 Hz, 2 s

Random sampling test (destructive test):

 2600 V_{AC}, 50 Hz, 60 s

Voltage proof of coating (destructive test):

 2600 V_{AC}, 50 Hz, 60 s

INSULATION RESISTANCE

≥ 10 000 MΩ

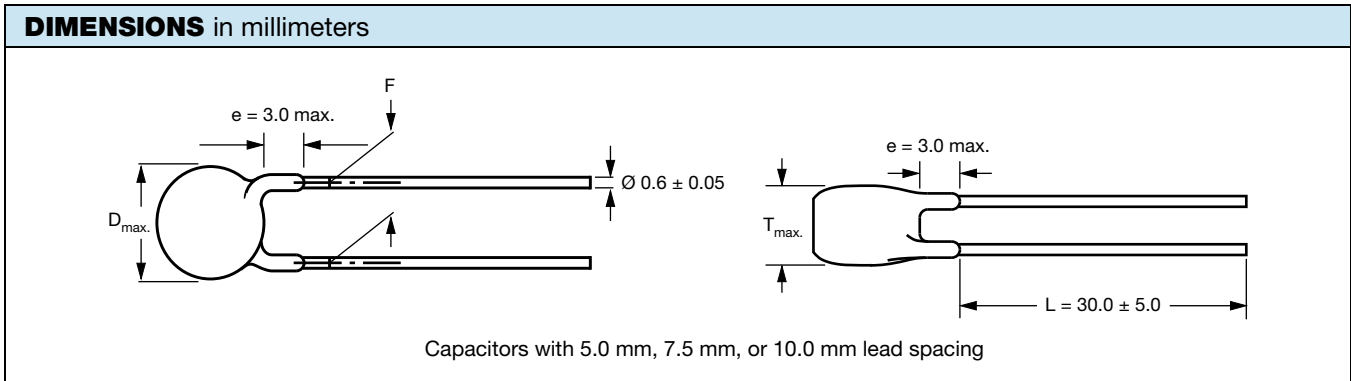
CAPACITANCE TOLERANCE

± 20 % (code M); ± 10 % (code K)

DISSIPATION FACTOR

Class 1: max. 0.3 % (1 MHz)

Class 2: max. 2.5 % (1 kHz)



TECHNICAL DATA					
CAPACITANCE C (pF)	CAPACITANCE TOLERANCE (%)	BODY DIAMETER D _{max.} (mm)	BODY THICKNESS T _{max.} (mm)	LEAD SPACING F (mm) ± 1 mm	PART NUMBER
					MISSING DIGITS SEE ORDERING CODE BELOW
U2J (N750)					
10	± 10	7.5	5.0	5.0, 7.5, or 10.0	AY2100K29U2JS6###
15					AY2150K29U2JS6###
22					AY2220K29U2JS6###
33					AY2330K29U2JS6###
47					AY2470K29U2JS6###
Y5S (2C3)					
68	± 10	7.5	5.0	5.0, 7.5, or 10.0	AY2680K29Y5SS6###
100					AY2101K29Y5SS6###
150					AY2151K29Y5SS6###
220					AY2221K29Y5SS6###
330					AY2331K29Y5SS6###
470					AY2471K29Y5SS6###
Y5U (2E3)					
680	± 20 ⁽¹⁾	7.5	5.0	5.0, 7.5, or 10.0	AY2681#29Y5US6###
1000					AY2102#29Y5US6###
1500		8.5			AY2152#31Y5US6###
2200		9.5			AY2222#35Y5US6###
3300		11.0			AY2332#41Y5US6###
3900		11.5			AY2392#43Y5US6###
4700		13.0			AY2472#49Y5US6###

Note
⁽¹⁾ ± 10 % available on request

ORDERING CODE										
#	7 th digit	Capacitance tolerance			± 10 % = K, ± 20 % = M					
###	15 th to 17 th digit	Lead configuration			Available configurations see below					
Example	AY2	221	K	29	Y5S	S	6	U	V	7
	Series	Capacitance value	Tolerance code	Size code	Temperature coefficient	Rated voltage	Lead wire diameter	Packaging / lead length	Lead style	Lead spacing
								3 = bulk T = tape and reel U = ammopack	L = straight V = inline kinked	5 = 5.0 7 = 7.5 0 = 10.0

LEADSPACING 5.0 mm and 7.5 mm

PACKAGING					
CAPACITANCE VALUE	SIZE CODE	BODY DIAMETER $D_{max.}$ (mm)	PACKAGING QUANTITIES		
			BULK	REEL	AMMO
10 pF to 4700 pF	29 to 49	13.0	1000	1000	1000

LEADSPACING 10.0 mm

PACKAGING					
CAPACITANCE VALUE	SIZE CODE	BODY DIAMETER $D_{max.}$ (mm)	PACKAGING QUANTITIES		
			BULK	REEL	AMMO
10 pF to 4700 pF	29 to 49	13.0	1000	500	750

Note

- The capacitors are supplied in bulk packaging (cardboard boxes), in tape on reel in ammopack.

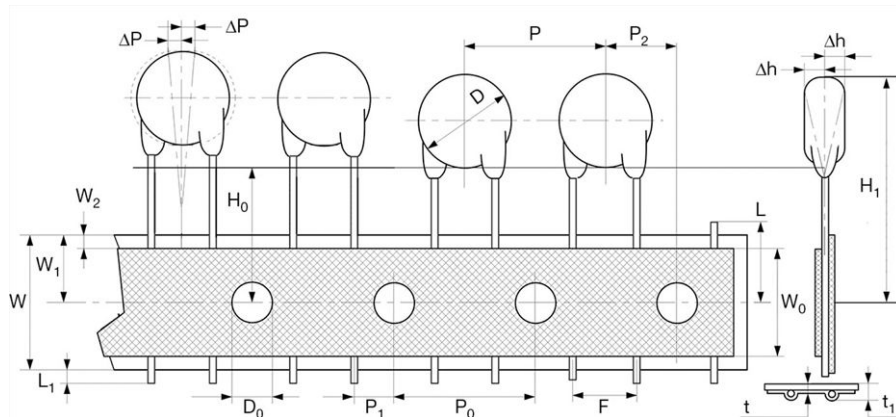
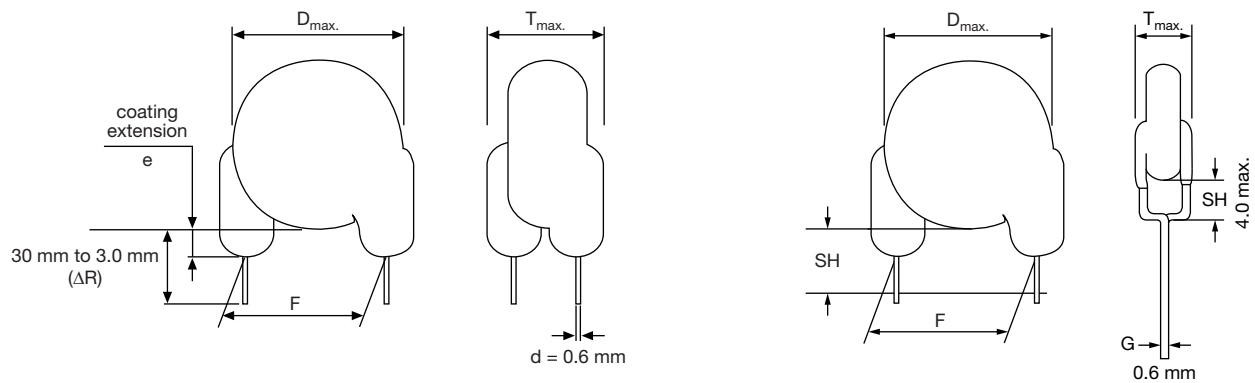
STRAIGHT LEADS
INLINE KINKED LEADS


Fig. 1 - The hole pitch 12.7 mm for lead spacing 5.0 mm (0.2"), and hole pitch 15.0 mm for lead spacing 7.5 mm (0.3")

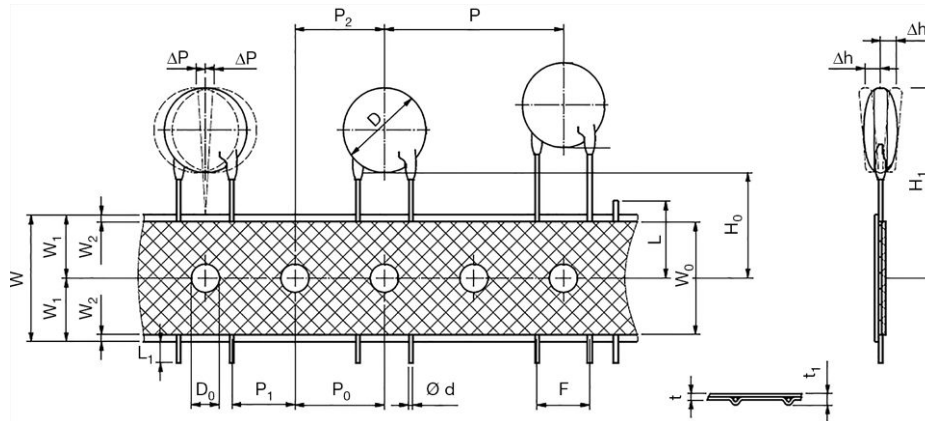
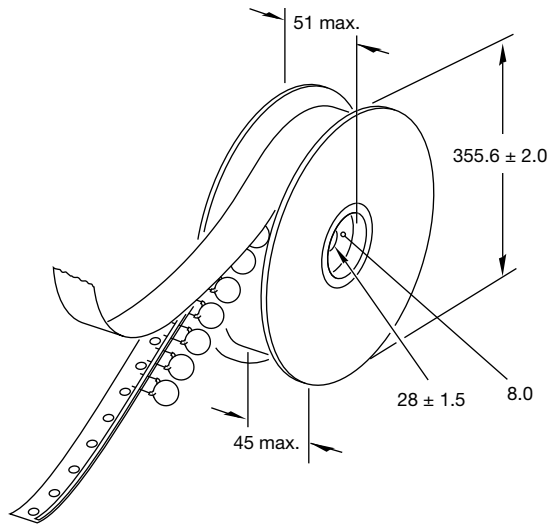


Fig. 2 - The hole pitch 12.7 mm for lead spacing 10.0 mm (0.4")

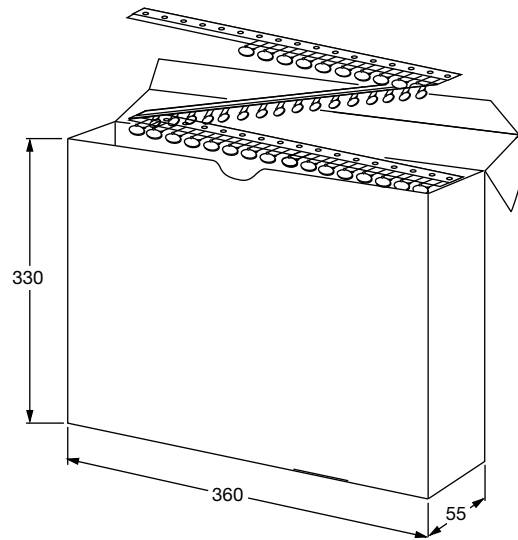
DIMENSION OF TAPE				
SYMBOL	PARAMETER	DIMENSIONS (mm)		
		FIG. 1 (5 mm)	FIG. 1 (7.5 mm)	FIG. 2 (10 mm)
D ⁽¹⁾	Body diameter	11.0 max.	14.0 max.	16.0 max.
d	Lead diameter	0.6 ± 0.05	0.6 ± 0.05	0.6 ± 0.05
P	Pitch of component	12.7 ± 1	15.0 ± 1	25.4 ± 1
P ₀ ⁽²⁾	Pitch of sprocket hole	12.7 ± 0.3	15.0 ± 0.3	12.7 ± 0.3
P ₁ ⁽³⁾	Distance, hole center to lead	3.85 ± 0.7	3.75 ± 0.7	7.7 ± 1.0
P ₂ ⁽³⁾	Distance, hole to center of component	6.35 ± 1.3	7.5 ± 1.5	12.7 ± 1.5
F	Lead spacing	5.0 (+ 0.6/- 0.4)	7.5 (+ 0.6/- 0.4)	10.0 (+ 0.6/- 0.4)
Δh	Average deviation across tape	± 1.0 max.	± 1.0 max.	± 1.0 max.
ΔP	Average deviation in direction of reeling	± 1.0 max.	± 1.0 max.	± 1.0 max.
W	Carrier tape width	18.0 + 1/- 0.5	18.0 + 1/- 0.5	18.0 + 1/- 0.5
W ₀	Hold-down tape width	5.0 min.	5.0 min.	5.0 min.
W ₁	Position of sprocket hole	9.0 + 0.75/- 0.5	9.0 + 0.75/- 0.5	9.0 + 0.75/- 0.5
W ₂	Distance of hold-down tape	3.0 max.	3.0 max.	3.0 max.
H ₁	Maximum component height	32	40	40
H ₀	Height to seating plane (for kinked leads)	16.0 ± 0.5	16.0 ± 0.5	16.0 ± 0.5
H ₀	Height to seating plane (for straight leads)	20.0 ± 0.5	20.0 ± 0.5	20.0 ± 0.5
L	Length of cut leads	11.0 max.	11.0 max.	11.0 max.
L ₁	Length of lead protrusion	1.0 max.	1.0 max.	1.0 max.
D ₀	Diameter of sprocket hole	4.0 ± 0.2	4.0 ± 0.2	4.0 ± 0.2
t	Total tape thickness	0.9 max.	0.9 max.	0.9 max.
t ₁	Maximum thickness of tape and wires	1.5 max.	1.5 max.	1.5 max.

Notes

- (1) See "Technical Data" table
 (2) Cumulative pitch error: ± 1 mm/20 pitches
 (3) Obliquity maximum 3°

REEL AND TAPE DATA in millimeters


Reel with capacitors on tape



Ammpack with capacitors on tape

APPROVALS

IEC 60384-14.4 - Safety tests
 This approval together with CB test certificate substitutes all national approvals.

CB Certificate

Y2-capacitor: CB test certificate:	US-26163-UL	10 pF to 4.7 nF	300 V _{AC}	
X1-capacitor: CB test certificate:	US-26163-UL	10 pF to 4.7 nF	440 V _{AC}	

VDE

Y2-capacitor: VDE marks approval:	40009669	10 pF to 4.7 nF	300 V _{AC}	
X1-capacitor: VDE marks approval:	40009669	10 pF to 4.7 nF	440 V _{AC}	

DIN EN 60384-14 VDE 0565-1-1:2006-04 - Safety tests

Underwriters Laboratories Inc./Canadian Standards Association

Y2-capacitor: UL-test certificate:	E183844	10 pF to 4.7 nF	300 V _{AC}	
X1-capacitor: UL-test certificate:	E183844	10 pF to 4.7 nF	440 V _{AC}	

UL 60384-14, CSA E60384-1:03 2nd edition, CSA E60384-14:09 2nd edition

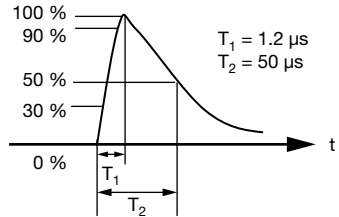
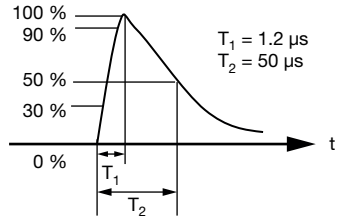
Across-the-line, antenna-coupling and line-by-pass component

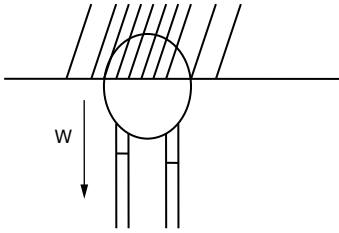
CQC

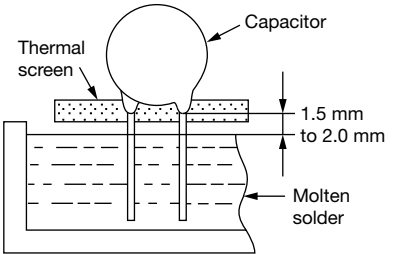
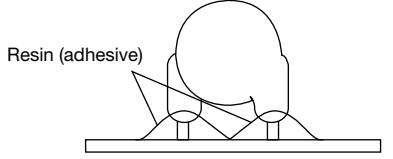
Y2-capacitor: CQC test certificate:	CQC05001012316	10 pF to 4.7 nF	300 V _{AC}	
X1-capacitor: CQC test certificate:	CQC05001012316	10 pF to 4.7 nF	440 V _{AC}	

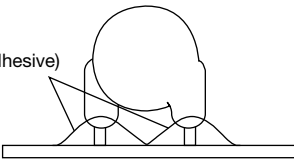
MARKING	
<p>Sample (2 sides)</p> <div style="display: flex; justify-content: space-around; align-items: center;"> <div style="text-align: center;"> Front </div> <div style="text-align: center;"> Back </div> </div> <p style="margin-left: 150px;">XX - Year ΔΔ - Week</p>	 PN: AY2472M49Y5US63LD Lot1: 14Z551S12 DC1: 0601 QTY: 225 Lot2: DC2: PO: Batch: 200601CN SO: Region: 9520 SL: 0010 Ser.No: 0601H69340 1/1

PERFORMANCE					
NO.	ITEMS		SPECIFICATION	TEST METHOD	
1	Visual and mechanical examination		No visible damage. The marking shall be legible. Dimensions are within specification.	Capacitors shall be visually inspected for visible evidence of defect. Dimensions shall be measured with calipers or micrometers.	
2	Capacitance		Within the specified tolerance.	The capacitance shall be measured at 25 °C ± 3 °C, 75 % RH maximum with 1.0 V _{RMS} ± 0.2 V _{RMS} , 1 kHz for Y5U, Y5S, and 1 MHz for U2J.	
3	Dissipation factor (D.F.)		U2J: 0.3 % max. Y5U, Y5S: 2.5 % max.	The dissipation factor shall be measured at 25 °C ± 3 °C, 75 % RH maximum with 1.0 V _{RMS} ± 0.2 V _{RMS} , 1 kHz for Y5U, Y5S, and 1 MHz for U2J.	
4	Insulation resistance (I.R.)		10 GΩ min.	Insulation resistance shall be measured within 60 s ± 5 s of charging at 500 V _{DC} .	
5	Dielectric strength (between lead wires)		No damage.	2600 V _{AC} are applied for 60 s. 50 mA max. (destructive test)	
6	Temperature characteristic	External appearance	No visible damage. The marking shall be legible.	The capacitance shall be measured at each step specified in table below. The capacitance change from the value of step 3 shall not exceed the limit specified.	
		Capacitance change	n/a		
		Dissipation factor	U2J: 0.5 % max. at 1 V, 1 MHz Y5U, Y5S: 5 % max. at 1 V, 1 kHz		
		Insulation resistance	10 GΩ min. at 500 V _{DC} 60 s at 25 °C and -40 °C 500 MΩ min. at 500 V _{DC} 60 s at 125 °C		
	Dielectric strength (between lead wires)	5 s 250 % rated voltage			
				Step	Temperature
				1	25 °C ± 3 °C
				2	-40 °C ± 3 °C
				3	25 °C ± 3 °C
				4	125 °C ± 3 °C
				5	25 °C ± 3 °C

PERFORMANCE				
NO.	ITEMS		SPECIFICATION	TEST METHOD
7	High temperature operation life	External appearance	No visible damage. The marking shall be legible.	<p>Test voltage: 1.5 kV_{AC}, 60 s Impulse voltage: each individual capacitor shall be subjected to a 5 kV impulse for three times. Before the capacitors are applied to life test.</p>  <p>The specimen capacitors shall be submitted to an endurance test of 1000 h + 48 h / - 0 h in a chamber at 125 °C ± 3 °C with a voltage of 550 V_{AC}.</p> <p>Pre-treatment: capacitor shall be backed at 125 °C ± 3 °C for 1 h before initial measurements.</p> <p>Post-treatment: capacitors shall be placed at room condition for 24 h ± 2 h before measurements.</p>
		Capacitance change	± 15 % max.	
		Dissipation factor	U2J: 0.5 % max. at 1 V, 1 MHz Y5U, Y5S: 5 % max. at 1 V, 1 kHz	
		Insulation resistance	3 GΩ min. at 500 V _{DC} , 60 s	
		Dielectric strength (between lead wires)	No failure at 1.5 kV _{AC} , 60 s	
8	Life Test	External appearance	No visible damage. The marking shall be legible.	<p>Test voltage: 1.5 kV_{AC}, 60 s Impulse voltage: each individual capacitor shall be subjected to a 5 kV impulse for three times. Before the capacitors are applied to life test.</p>  <p>The specimen capacitors shall be submitted to an endurance test of 1000 h + 48 h / - 0 h in a chamber at 125 °C ± 3 °C with a voltage of 550 V_{AC}, except that once every hour the voltage shall be increase to 1000 V_{AC} for 0.1 s.</p> <p>Pre-treatment: capacitor shall be backed at 125 °C ± 3 °C for 1 h before initial measurements.</p> <p>Post-treatment: capacitors shall be placed at room condition for 24 h ± 2 h before measurements.</p>
		Capacitance change	± 15 % max.	
		Dissipation factor	U2J: 0.5 % max. at 1 V, 1 MHz Y5U, Y5S: 5 % max. at 1 V, 1 kHz	
		Insulation resistance	3 GΩ min. at 500 V _{DC} , 60 s	
		Dielectric strength (between lead wires)	No failure at 1.5 kV _{AC} , 60 s	

PERFORMANCE						
NO.	ITEMS		SPECIFICATION	TEST METHOD		
9	Humidity test (under steady state)	External appearance	No visible damage.	Ambient temperature: 40 °C ± 2 °C Relative humidity: 90 % to 95 % RH Duration: 500 h + 48 h / - 0 h Without loading Pre-treatment: capacitor shall be stored at 40 °C ± 2 °C for 24 h ± 5 h before initial measurements. Post-treatment: capacitor shall be stored for 2 h at room conditions before final measurements.		
		Capacitance change	U2J: ± 10 % Y5U, Y5S: ± 20 %			
		Dissipation factor	U2J: 0.5 % max. at 1 V, 1 MHz Y5U, Y5S: 5 % max. at 1 V, 1 kHz			
		Insulation resistance	3 GΩ min. at 500 V _{DC} , 60 s			
		Dielectric strength (between lead wires)	No failure at 1.5 kV _{AC} , 60 s			
10	Humidity test (under load state)	External appearance	No visible damage. The marking shall be legible.	Ambient temperature: 40 °C ± 2 °C Relative humidity: 90 % to 95 % RH Duration: 500 h + 48 h / - 0 h Loading voltage: 440 V _{AC} Pre-treatment: capacitor shall be stored at 40 °C ± 5 °C for 24 h ± 2 h before initial measurements. Post-treatment: capacitor shall be stored for 2 h at room conditions before final measurements.		
		Capacitance change	U2J: ± 10 % Y5U, Y5S: ± 15 %			
		Dissipation factor	U2J: 0.5 % max. at 1 V, 1 MHz Y5U, Y5S: 5 % max. at 1 V, 1 kHz			
		Insulation resistance	3 GΩ min. at 500 V _{DC} , 60 s			
		Dielectric strength (between lead wires)	No failure at 1.5 kV _{AC} , 60 s			
11	Biased humidity	External appearance	No visible damage. The marking shall be legible.	Loading voltage: 440 V _{AC} Ambient temperature: 85 °C ± 3 °C Relative humidity: 85 % RH Duration: 1000 h + 48 h / - 0 h Pre-treatment: capacitor shall be stored at 40 °C ± 5 °C for 24 h ± 2 h, then place at room condition for 24 h ± 2 h before initial measurements. Post-treatment: capacitor shall be stored for 24 h at room conditions before final measurements.		
		Capacitance change	U2J: ± 10 % Y5U, Y5S: ± 15 %			
		Dissipation factor	U2J: 0.5 % max. at 1 V, 1 MHz Y5U, Y5S: 5 % max. at 1 V, 1 kHz			
		Insulation resistance	3 GΩ min. at 500 V _{DC} , 60 s			
		Dielectric strength (between lead wires)	No failure at 1.5 kV _{AC} , 60 s			
12	Termination strength	Pull test	External appearance	As a figure, fix the body of capacitor, apply a tensile weight gradually to each lead wire in the radial direction of capacitor up to 20 N, and keep it for 10 s ± 1 s. 		
			Capacitance change		Within specification	
			Dissipation factor		Within specification	
			Insulation resistance		Within specification	
		Bending test	External appearance		Lead wire should not be cut off, capacitor should not be broken. Bending each lead wire to 90° from the lead egress with 2.5 N force, then back to original position and bent again from the same direction. Totally 3 bends, 3 s each time. 1 bend: bending to 90° the return to normal position is one bend. Start from 1.6 mm to 3.2 mm from the part body.	

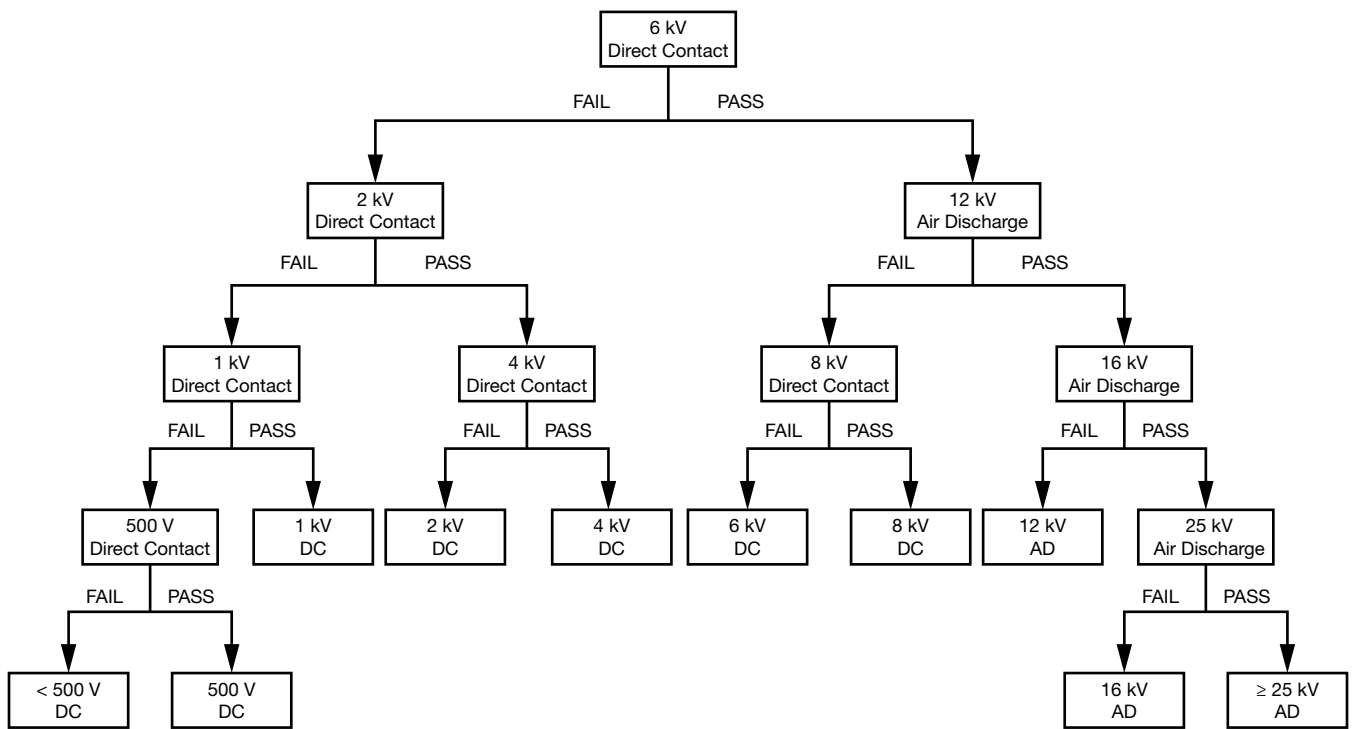
PERFORMANCE				
NO.	ITEMS		SPECIFICATION	TEST METHOD
13	Resistance to solder heat	Visual	No visible damage. The marking shall be legible.	<p>The lead wire shall be immersed into the melted solder of $260\text{ }^{\circ}\text{C} \pm 5\text{ }^{\circ}\text{C}$ up to about 1.5 mm to 2 mm from the main body for $10\text{ s} \pm 2\text{ s}$. Inspect under 10 x magnification</p>  <p>Pre-treatment: Capacitor shall be stored at $125\text{ }^{\circ}\text{C} \pm 5\text{ }^{\circ}\text{C}$ for 1 h, then placed at room condition for $24\text{ h} \pm 2\text{ h}$ before initial measurements.</p> <p>Post-treatment: Capacitor shall be stored for $24\text{ h} \pm 2\text{ h}$ at room condition.</p>
		Capacitance change	Within $\pm 10\%$	
		Dissipation factor	U2J: 0.5 % max. at 1 V, 1 MHz Y5U, Y5S: 5 % max. at 1 V, 1 kHz	
		Insulation resistance	1 G Ω min. at 500 V _{DC} , 60 s	
		Dielectric strength (between lead wires)	No failure at 1.5 kV _{AC} , 60 s	
14	Solderability	External appearance	95 % of terminations evenly covered with solder under 10 x magnification.	<p>Method A at category 3, steam aging for $8\text{ h} \pm 15\text{ min}$. Solder and temperature:</p> <p>a) Lead (Pb)-free solder (Sn-3Ag-0.5Cu) $245\text{ }^{\circ}\text{C} \pm 5\text{ }^{\circ}\text{C}$</p> <p>b) H63 eutectic solder $235\text{ }^{\circ}\text{C} \pm 5\text{ }^{\circ}\text{C}$ dip lead wire into an ethanol solution of $25\% \pm 0.5\%$ rosin and then into molten solder for $5\text{ s} + 0\text{ s} / - 0.5\text{ s}$.</p> <p>Depth of immersion within 1.25 mm, immerse and withdraw at $25\text{ mm/s} \pm 6\text{ mm/s}$</p>
15	Vibration test	Visual	No visible damage. The marking shall be legible.	 <p>Solder the capacitor and gum up the body to the test jig by resin (adhesive). The capacitor should be firmly soldered to the supporting lead wire. Vibration change from 10 Hz to 2000 Hz, then back to 10 Hz. Total amplitude: 1.5 mm with 5 g max., 12 cycles, 20 min for each mutually perpendicular directions, 3 directions.</p>
		Capacitance change	Within $\pm 10\%$	
		Dissipation factor	U2J: 0.5 % max. at 1 V, 1 MHz Y5U, Y5S: 5 % max. at 1 V, 1 kHz	
		Insulation resistance	10 G Ω min. at 500 V _{DC} , 60 s	

PERFORMANCE				
NO.	ITEMS		SPECIFICATION	TEST METHOD
16	Mechanical shock	External appearance	No visible damage. The marking shall be legible.	 <p>Resin (adhesive)</p> <p>Solder the capacitor and gum up the body to the test jig by resin (adhesive). 3 shocks in 2 directions should be applied, totally 3 mutually perpendicular axes, 18 shocks. Shock from: half-sine Duration: 6 ms Acceleration: 100 g</p>
		Capacitance change	Within the specified tolerance.	
		Dissipation factor	U2J: 0.5 % max. at 1 V, 1 MHz Y5U, Y5S: 5 % max. at 1 V, 1 kHz	
		Insulation resistance	10 GΩ min. at 500 V _{DC} , 60 s.	
17	Resistance to solvents	External appearance	No visible damage. The marking shall be legible.	<p>Leave parts in solvent for 3 to 8 min at 25 °C ± 5 °C, 1 min air-drying Rub parts against wet bristle 10 times (3 x for marking, 10 x for part damage)</p> <p>Solvent 1: 1 part (by volume) of isopropyl alcohol, 3 parts (by volume) of mineral spirits</p> <p>Solvent 2: Terpene defluxer</p> <p>Solvent 3: 42 parts (by volume) of water, 1 part (by volume) of propylene glycol, 1 part (by volume) of monoethanolamine</p>
18	Temperature cycle	Capacitance change	Within ± 10 % for U2J Within ± 20 % for Y5U and Y5S	<p>The capacitor should be run 1000 temperature cycles. Step as below: Step 1 -55 °C + 0 °C / - 3 °C, dwell time ≤ 30 min Step 2 Transition time ≤ 1 min Step 3 +125 °C + 3 °C / - 0 °C, dwell time ≤ 30 min Step 4 Transition time ≤ 1 min</p> <p>Pre-treatment: capacitor shall be stored at 125 °C ± 3 °C for 1 h, then placed at room condition for 24 h ± 2 h before initial measurement.</p> <p>Post-treatment: capacitor shall be stored for 24 h ± 2 h at room condition.</p>
		Dissipation factor	U2J: 0.5 % max. at 1 V, 1 MHz Y5U, Y5S: 5 % max. at 1 V, 1 kHz	
		Insulation resistance	3 GΩ min at 500 V _{DC} , 60 s	
		Dielectric strength	No failure at 1.5 kV _{AC} , 60 s	
		External appearance	No visible damage. The marking shall be legible.	
19	High temperature exposure (storage)	External appearance	No visible damage. The marking shall be legible.	<p>Storage capacitor at 125 °C ± 3 °C for 1000 h + 48 h / - 0 h without loading.</p> <p>Pre-treatment: capacitor shall be stored at 125 °C ± 3 °C for 1 h, then placed at room condition for 24 h ± 2 h before initial measurement.</p> <p>Post-treatment: capacitor shall be stored for 24 h ± 2 h at room condition.</p>
		Capacitance change	Within ± 10 % for U2J Within ± 20 % for Y5U and Y5S	
		Dissipation factor	U2J: 0.5 % max. at 1 V, 1 MHz Y5U, Y5S: 5 % max. at 1 V, 1 kHz	
		Insulation resistance	1 GΩ min. at 500 V _{DC} , 60 s	



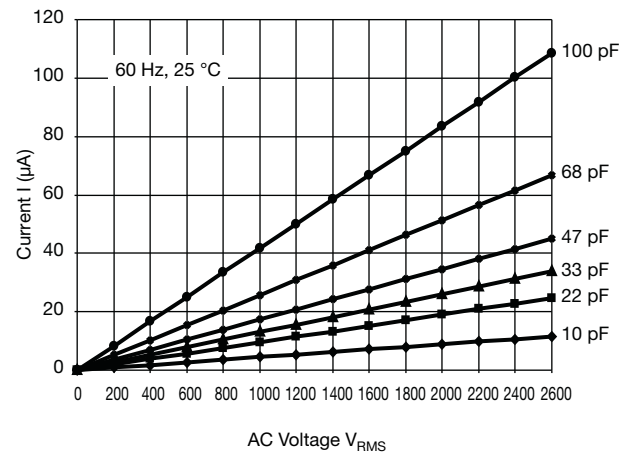
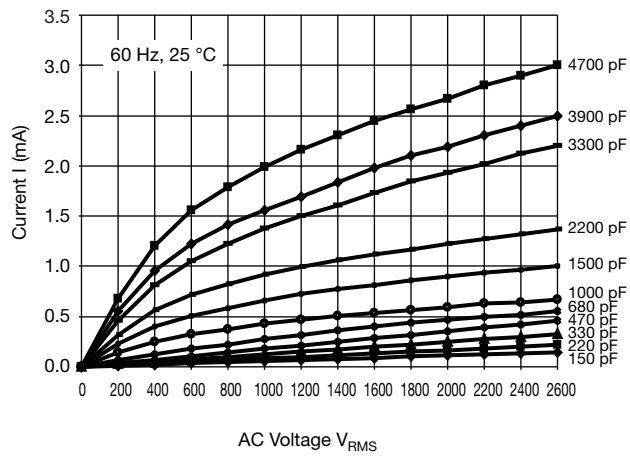
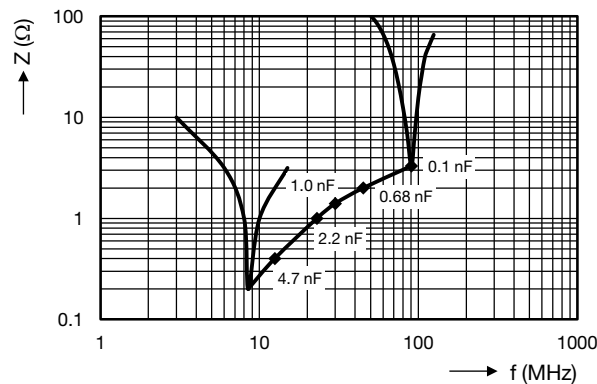
PERFORMANCE				
NO.	ITEMS	SPECIFICATION	TEST METHOD	
20	ESD	External appearance	No visible damage. The marking shall be legible.	See chart "ESD Test Method" below
		Capacitance change	Within $\pm 10\%$	
		Dissipation factor	U2J: 0.5 % max. at 1 V, 1 MHz Y5U, Y5S: 5 % max. at 1 V, 1 kHz	
		Insulation resistance	1 G Ω min. at 500 V _{DC} , 60 s.	

ESD TEST METHOD



Notes

- DC means "direct contact discharge".
- AC means "air discharge".
- Classify the components according to the highest ESD voltage level survived during ESD testing.

LEAKAGE CURRENT VS. VOLTAGE (Typical)

IMPEDANCE VS. FREQUENCY (Typical)


Lead configuration: length = 30 mm, lead spacing: standard, lead diameter: standard, inline crimp

Note

- The capacitors meet the essential requirements of "EIA 198". Unless stated otherwise all electrical values apply at an ambient temperature of $25\text{ °C} \pm 3\text{ °C}$, at normal atmospheric conditions.

RELATED DOCUMENTS	
General Information	www.vishay.com/doc?28536
CB Test Certificate	www.vishay.com/doc?22254
VDE Marks Approval	www.vishay.com/doc?22256
UL Test Certificate	www.vishay.com/doc?22253
CQC Test Certificate	www.vishay.com/doc?22255

SAMPLE KIT	
Part Number	AY21-KIT-HF
Link	www.vishay.com/doc?28553



Disclaimer

ALL PRODUCT, PRODUCT SPECIFICATIONS AND DATA ARE SUBJECT TO CHANGE WITHOUT NOTICE TO IMPROVE RELIABILITY, FUNCTION OR DESIGN OR OTHERWISE.

Vishay Intertechnology, Inc., its affiliates, agents, and employees, and all persons acting on its or their behalf (collectively, "Vishay"), disclaim any and all liability for any errors, inaccuracies or incompleteness contained in any datasheet or in any other disclosure relating to any product.

Vishay makes no warranty, representation or guarantee regarding the suitability of the products for any particular purpose or the continuing production of any product. To the maximum extent permitted by applicable law, Vishay disclaims (i) any and all liability arising out of the application or use of any product, (ii) any and all liability, including without limitation special, consequential or incidental damages, and (iii) any and all implied warranties, including warranties of fitness for particular purpose, non-infringement and merchantability.

Statements regarding the suitability of products for certain types of applications are based on Vishay's knowledge of typical requirements that are often placed on Vishay products in generic applications. Such statements are not binding statements about the suitability of products for a particular application. It is the customer's responsibility to validate that a particular product with the properties described in the product specification is suitable for use in a particular application. Parameters provided in datasheets and / or specifications may vary in different applications and performance may vary over time. All operating parameters, including typical parameters, must be validated for each customer application by the customer's technical experts. Product specifications do not expand or otherwise modify Vishay's terms and conditions of purchase, including but not limited to the warranty expressed therein.

Except as expressly indicated in writing, Vishay products are not designed for use in medical, life-saving, or life-sustaining applications or for any other application in which the failure of the Vishay product could result in personal injury or death. Customers using or selling Vishay products not expressly indicated for use in such applications do so at their own risk. Please contact authorized Vishay personnel to obtain written terms and conditions regarding products designed for such applications.

No license, express or implied, by estoppel or otherwise, to any intellectual property rights is granted by this document or by any conduct of Vishay. Product names and markings noted herein may be trademarks of their respective owners.