

50 Ω nominal input / conjugate matched balun to ST S2-LP, 433 MHz with integrated harmonic filter

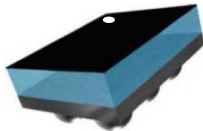

Flip-Chip (6 bumps) package

Pinout diagram - Top view

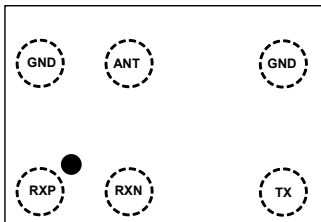

Features

- 50 Ω nominal input / conjugate matched to ST S2-LP for 433 MHz frequency operation
- Low insertion loss
- Low amplitude imbalance
- Low phase imbalance
- Small footprint
- Very low profile < 620 μm after reflow
- High RF performance
- RF BOM and area reduction
- ECOPACK[®]2 compliant component

Applications

- 433 MHz impedance matched balun filter
- Optimized for ST S2-LP sub GHz RFIC

Description

This device is an ultra-miniature balun. The BALF-SPI2-02D3 integrates matching network and harmonics filter. Matching impedance has been customized for the ST S2-LP transceiver. The BALF-SPI2-02D3 uses STMicroelectronics IPD technology on non-conductive glass substrate which optimize RF performance.

Product status

BALF-SPI2-02D3

1 Characteristics

Table 1. Absolute maximum ratings ($T_{amb} = 25\text{ }^{\circ}\text{C}$)

Symbol	Parameter	Value	Unit
P_{IN}	Input power RF_{IN}	20	dBm
V_{ESD}	ESD ratings human body model (JESD22-A114), all I/O one at a time while others connected to GND	2000	V
	ESD ratings machine model (JESD22-A115), all I/O	200	
T_{OP}	Operating temperature	-40 to +105	$^{\circ}\text{C}$

Table 2. Impedances ($T_{amb} = 25\text{ }^{\circ}\text{C}$)

Symbol	Parameter	Value			Unit
		Min.	Typ.	Max.	
Z_{RX}	Nominal differential RX balun impedance	-	matched ST S2-LP	-	Ω
Z_{TX}	Nominal TX filter impedance				
Z_{ANT}	Antenna impedance	-	50	-	Ω

Table 3. Electrical characteristics and RF performances ($T_{amb} = 25\text{ }^{\circ}\text{C}$)

Symbol	Parameter	Test condition	Value			Unit
			Min.	Typ.	Max.	
f	Frequency range			433		MHz
IL_{RX-ANT}	Insertion loss in bandwidth without mismatch loss (RX balun)			1.95	2.20	dB
IL_{TX-ANT}	Insertion loss in bandwidth without mismatch loss (TX filter)			3.15	3.60	dB
RL_{RX-ANT}	Input return loss in bandwidth (RX balun)		11	12		dB
RL_{TX-ANT}	Input return loss in bandwidth (TX filter)		6.5	8.0		dB
ϕ_{imb}	Output phase imbalance (RX balun)		-2.1		2.1	$^{\circ}$
A_{imb}	Output amplitude imbalance (RX balun)		-1.1		1.1	dB
Att	Harmonic levels (TX filter)	Attenuation at 2fo	52	58		dB
		Attenuation at 3fo	53	63		
		Attenuation at 4fo	54	55		
		Attenuation at 5fo	54	55		
		Attenuation at 6fo	55	56		
		Attenuation at 7fo	56	57		

1.1 RF measurements (Rx balun)

Figure 1. Insertion loss

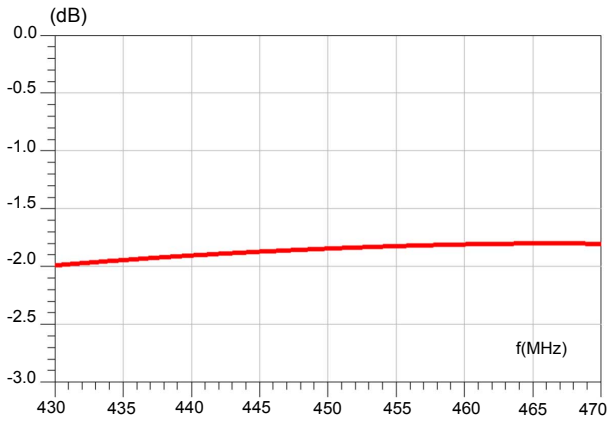

Figure 2. Return loss on antenna

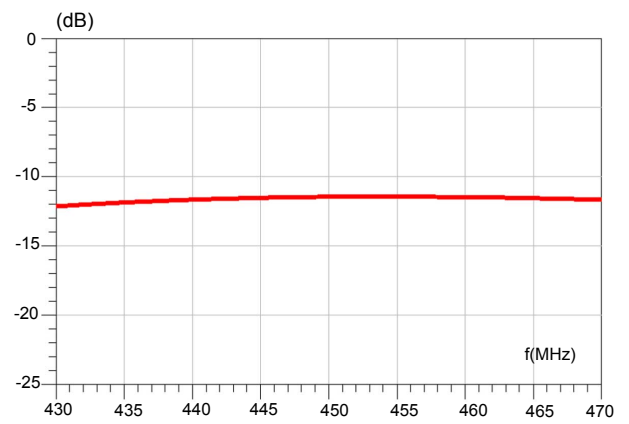

Figure 3. Amplitude imbalance

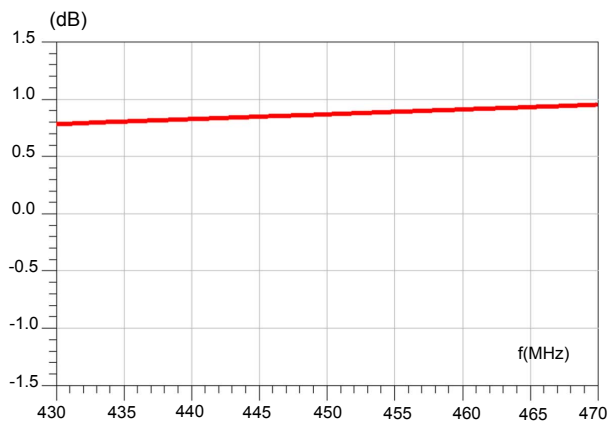
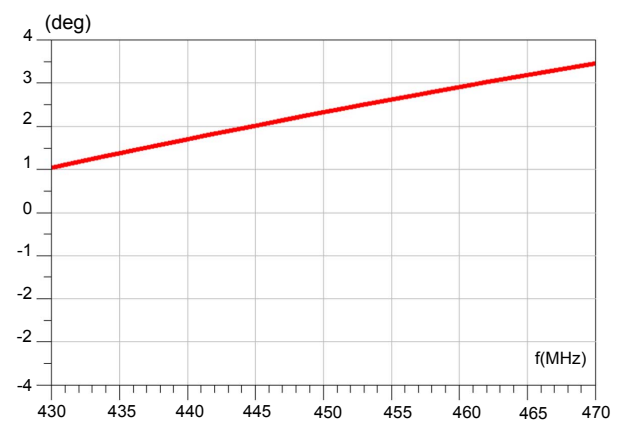

Figure 4. Phase imbalance



1.2 RF measurements (Tx filter)

Figure 5. Transmission

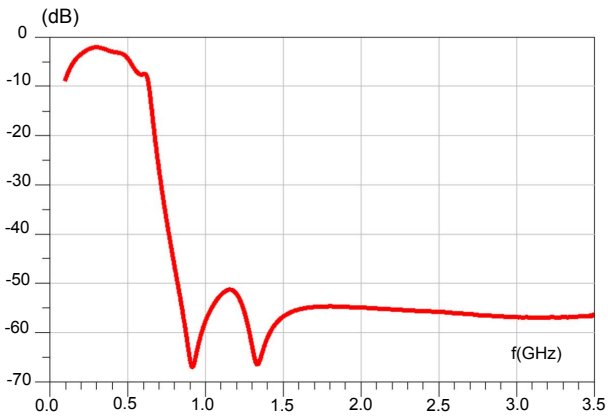

Figure 6. Insertion loss

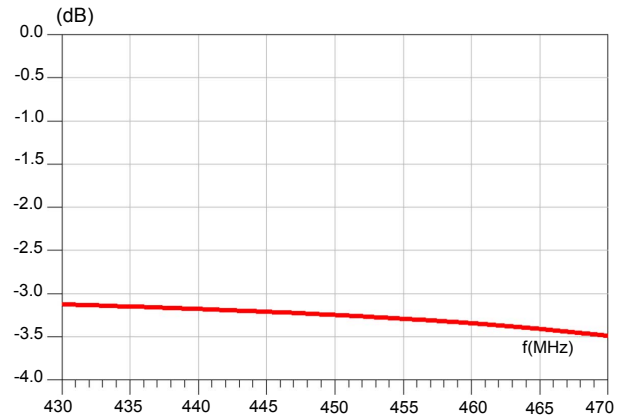
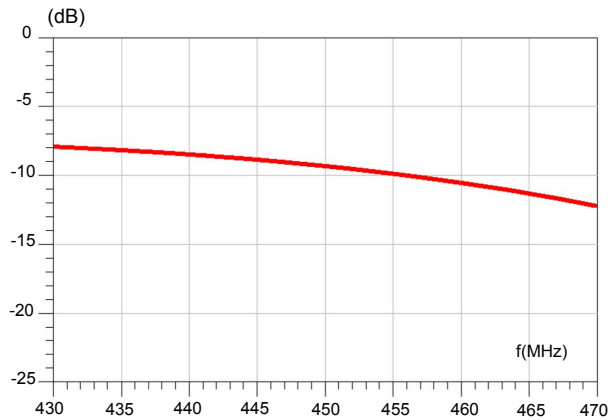
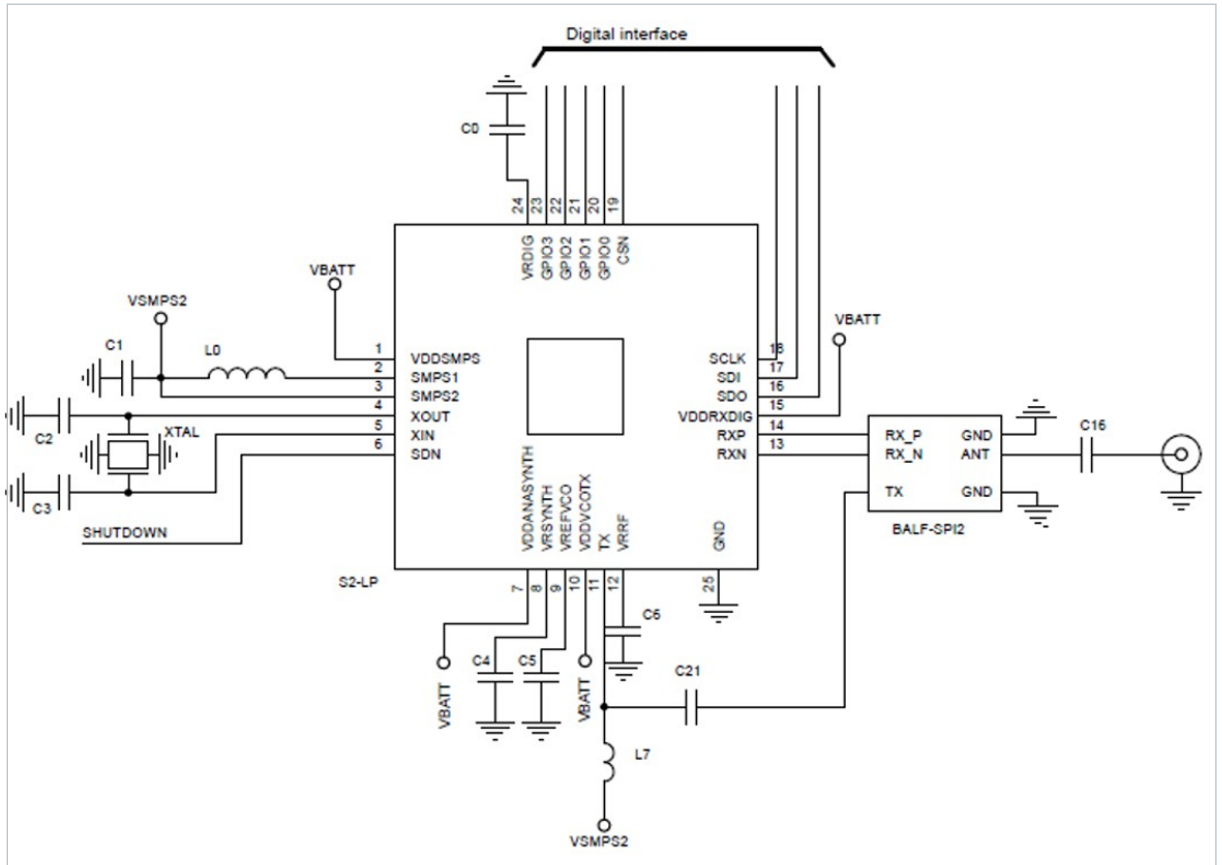

Figure 7. Return loss on antenna



1.3 ST S2-LP application diagram example

Figure 8. ST S2-LP application diagram example

2 Package information

In order to meet environmental requirements, ST offers these devices in different grades of ECOPACK® packages, depending on their level of environmental compliance. ECOPACK® specifications, grade definitions and product status are available at: www.st.com. ECOPACK® is an ST trademark.

2.1 Flip-Chip 6 bumps package information

Figure 9. Flip-Chip 6 bumps package outline (bottom and side view)

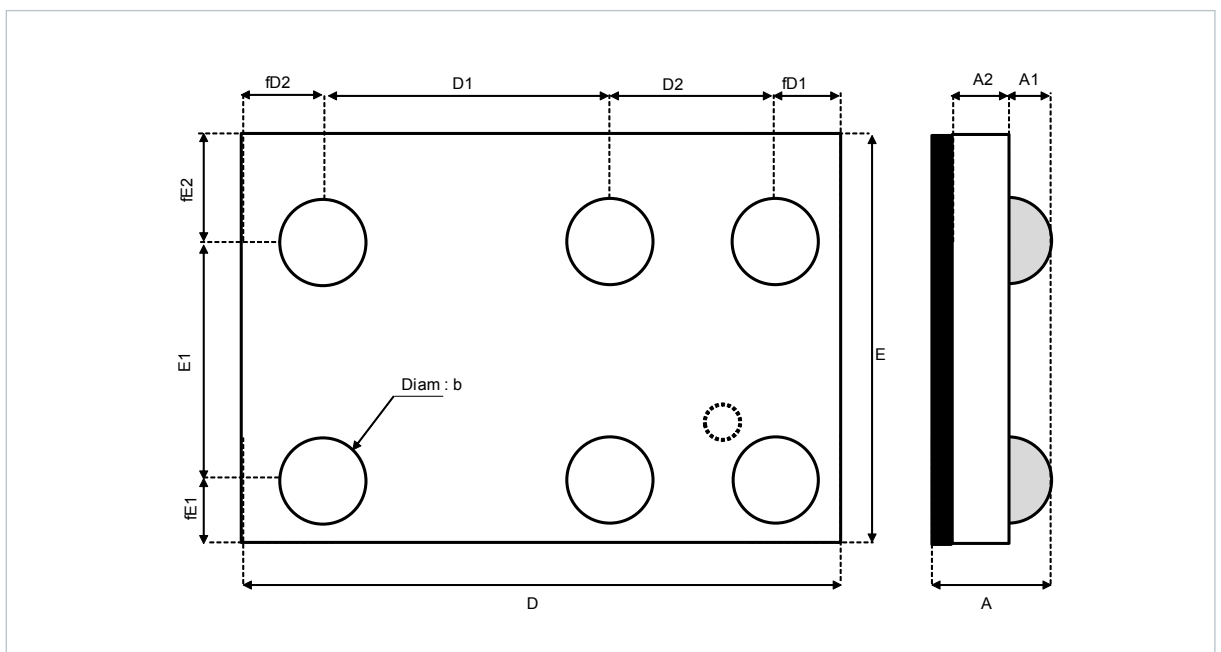
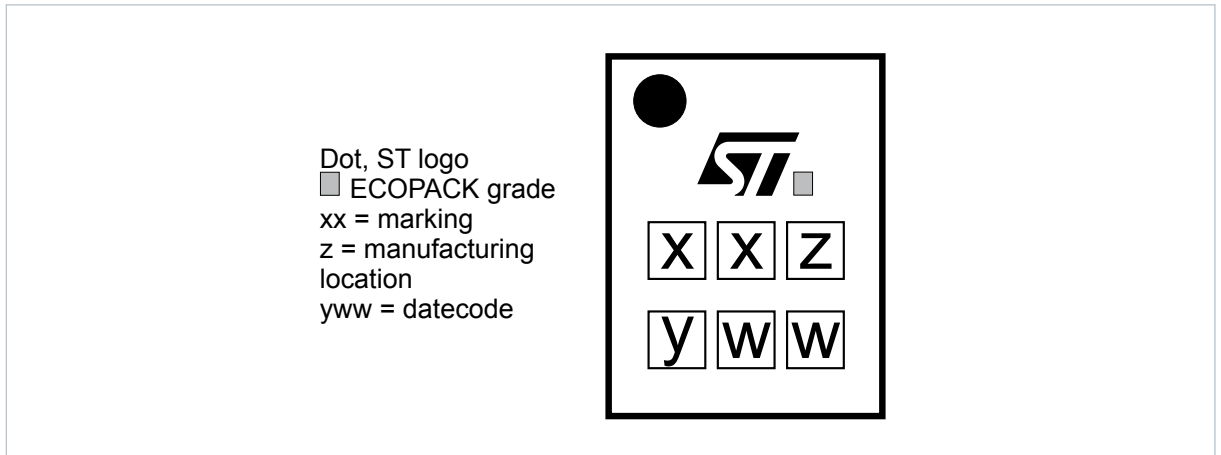
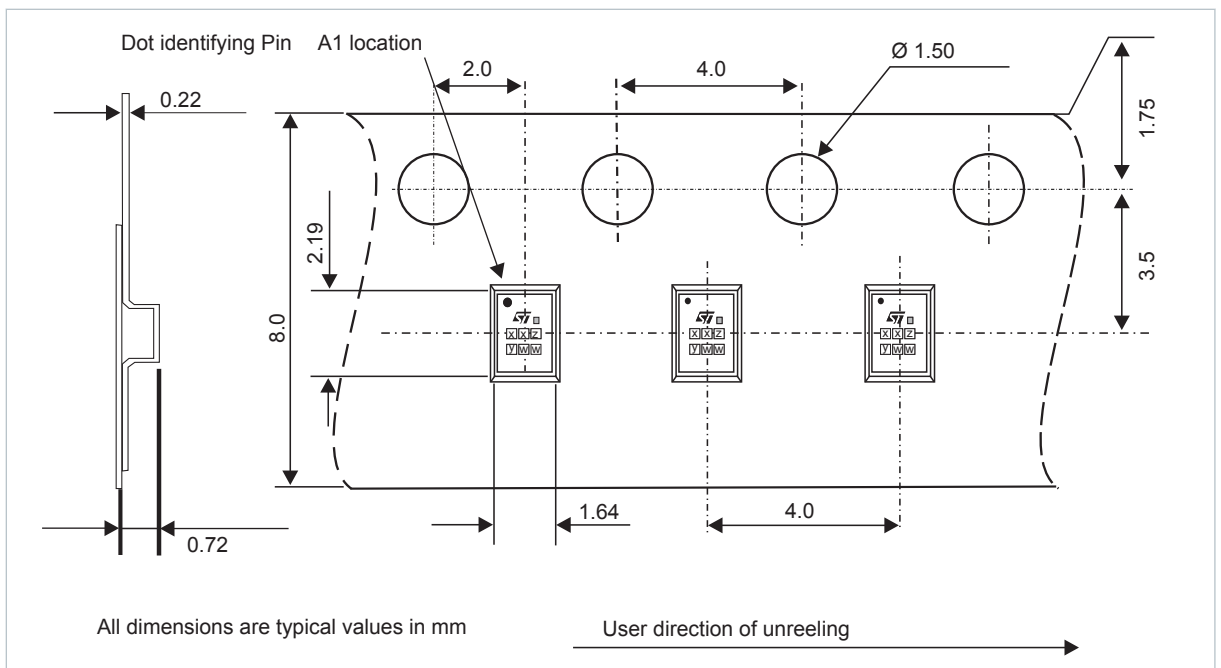

Table 4. Flip-Chip 6 bumps dimensions (in mm)

Parameter	Min.	Typ.	Max.
A	0.580	0.630	0.680
A1	0.180	0.205	0.230
A2	0.380	0.400	0.420
b	0.230	0.255	0.280
D	2.050	2.100	2.150
D1		1.210	
D2		0.500	
E	1.500	1.550	1.600
E1		1.060	
fD1		0.195	
fD2		0.195	
fE1		0.195	
fE2		0.295	

2.2 Flip-chip 6 bumps packing information

Figure 10. Marking

Figure 11. Flip Chip tape and reel specifications

3 PCB assembly recommendations

3.1 Land pattern

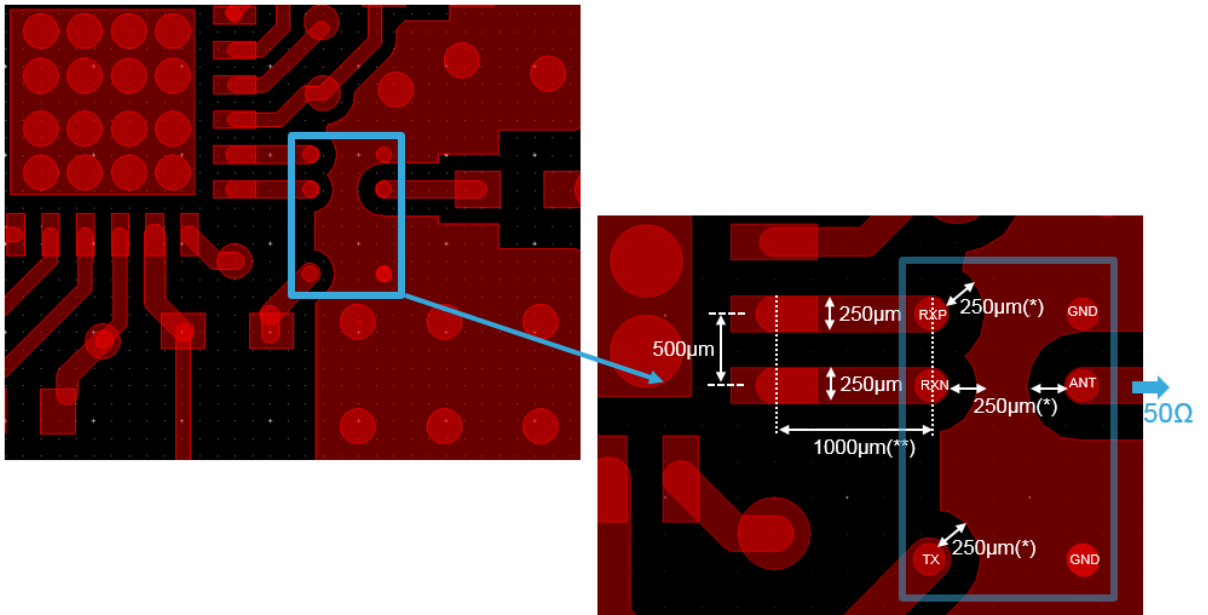
Figure 12. Recommended balun land pattern



Note: (*)Clearance 250 µm is needed to ensure good sensitivity.
(**)1000 µm length between S2-LP & balun (between center QFN pads to center IPD pads).

Figure 13. PCB stack-up recommendations

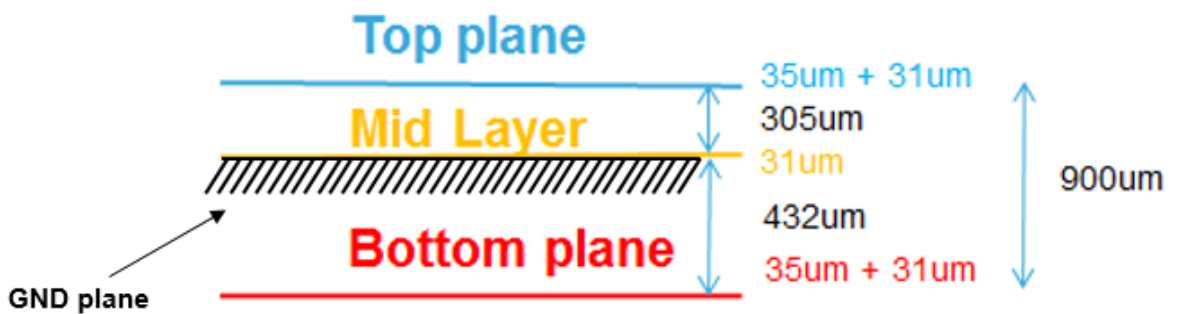

3.2 Stencil opening design

Figure 14. Footprint - 3 mils stencil -non solder mask defined

Copper pad diameter:
 220 μm recommended
 180 μm minimum
 260 μm maximum

Solder mask opening:
 320 μm recommended
 300 μm minimum
 340 μm maximum

Solder stencil opening:
 220 μm recommended

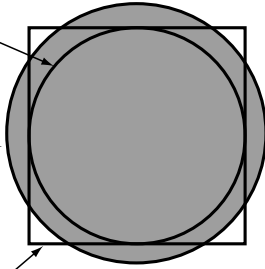

Figure 15. Footprint - 3 mils stencil - solder mask defined

Solder mask opening:
 220 μm recommended
 180 μm minimum
 260 μm maximum

Copper pad diameter:
 320 μm recommended
 300 μm minimum

Solder stencil opening:
 220 μm recommended

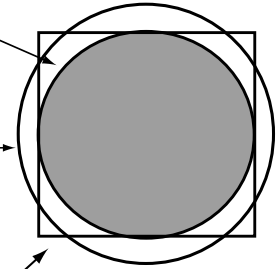

Figure 16. Footprint - 5 mils stencil -non solder mask defined

Copper pad diameter:
 220 μm recommended
 180 μm minimum
 260 μm maximum

Solder mask opening:
 320 μm recommended
 300 μm minimum
 340 μm maximum

Solder stencil opening:
 330 μm recommended*

*depending on paste, it can go down to 270 μm

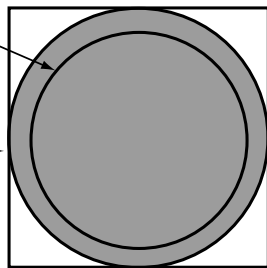

Figure 17. Footprint - 5 mils stencil - solder mask defined

Solder mask opening:
 220 μm recommended
 180 μm minimum
 260 μm maximum

Copper pad diameter:
 320 μm recommended
 300 μm minimum

Solder stencil opening:
 330 μm recommended*

*depending on paste, it can go down to 270 μm

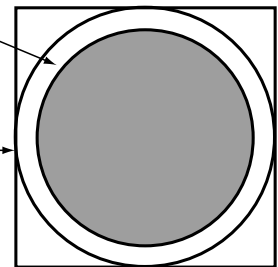

3.3 Solder paste

1. Halide-free flux qualification ROL0 according to ANSI/J-STD-004.
2. "No clean" solder paste is recommended.
3. Offers a high tack force to resist component movement during high speed.
4. Use solder paste with fine particles: powder particle size 20-38 μm .

3.4 Placement

1. Manual positioning is not recommended.
2. It is recommended to use the lead recognition capabilities of the placement system, not the outline centering
3. Standard tolerance of ± 0.05 mm is recommended.
4. 1.0 N placement force is recommended. Too much placement force can lead to squeezed out solder paste and cause solder joints to short. Too low placement force can lead to insufficient contact between package and solder paste that could cause open solder joints or badly centered packages.
5. To improve the package placement accuracy, a bottom side optical control should be performed with a high resolution tool.
6. For assembly, a perfect supporting of the PCB (all the more on flexible PCB) is recommended during solder paste printing, pick and place and reflow soldering by using optimized tools.

3.5 PCB design preference

1. To control the solder paste amount, the closed via is recommended instead of open vias.
2. The position of tracks and open vias in the solder area should be well balanced. A symmetrical layout is recommended, to avoid any tilt phenomena caused by asymmetrical solder paste due to solder flow away.

3.6 Reflow profile

Figure 18. ST ECOPACK® recommended soldering reflow profile for PCB mounting

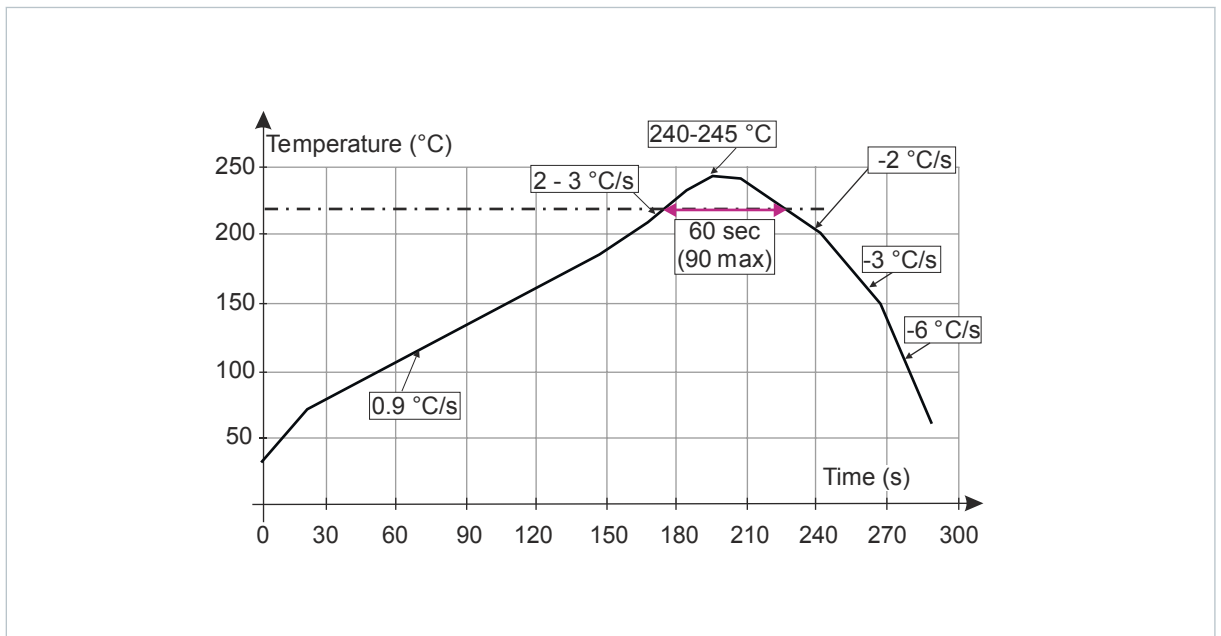

Note: Minimize air convection currents in the reflow oven to avoid component movement.

Note: More information is available in the application note:

- AN2348 Flip-Chip: "Package description and recommendations for use"

4 Ordering information

Table 5. Ordering information

Order code	Marking	Package	Weight	Base qty.	Delivery mode
BALF-SPI2-02D3	TN	Flip-Chip 6 bumps	3.4 mg	5000	Tape and reel

Revision history

Table 6. Document revision history

Date	Revision	Changes
02-May-2018	1	Initial release.

IMPORTANT NOTICE – PLEASE READ CAREFULLY

STMicroelectronics NV and its subsidiaries (“ST”) reserve the right to make changes, corrections, enhancements, modifications, and improvements to ST products and/or to this document at any time without notice. Purchasers should obtain the latest relevant information on ST products before placing orders. ST products are sold pursuant to ST’s terms and conditions of sale in place at the time of order acknowledgement.

Purchasers are solely responsible for the choice, selection, and use of ST products and ST assumes no liability for application assistance or the design of Purchasers’ products.

No license, express or implied, to any intellectual property right is granted by ST herein.

Resale of ST products with provisions different from the information set forth herein shall void any warranty granted by ST for such product.

ST and the ST logo are trademarks of ST. All other product or service names are the property of their respective owners.

Information in this document supersedes and replaces information previously supplied in any prior versions of this document.

© 2018 STMicroelectronics – All rights reserved