

PMSTA3904

40 V, 200 mA NPN switching transistor

Rev. 01 — 21 April 2008

Product data sheet

1. Product profile

1.1 General description

Single NPN switching transistor in a SOT323 (SC-70) very small Surface-Mounted Device (SMD) plastic package.

PNP complement: PMST3906.

1.2 Features

- Single NPN switching transistor
- Integrated extraction electrode for fast switching
- AEC-Q101 qualified

1.3 Applications

- General-purpose switching and amplification

1.4 Quick reference data

Table 1. Quick reference data

Symbol	Parameter	Conditions	Min	Typ	Max	Unit
V_{CEO}	collector-emitter voltage	open base	-	-	40	V
I_C	collector current		-	-	200	mA
h_{FE}	DC current gain	$V_{CE} = 1\text{ V};$ $I_C = 10\text{ mA}$	100	195	300	

2. Pinning information

Table 2. Pinning

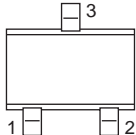
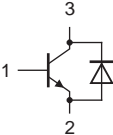
Pin	Description	Simplified outline	Graphic symbol
1	base		
2	emitter		
3	collector		

006aab209

3. Ordering information

Table 3. Ordering information

Type number	Package		
	Name	Description	Version
PMSTA3904	SC-70	plastic surface-mounted package; 3 leads	SOT323

4. Marking

Table 4. Marking codes

Type number	Marking code ^[1]
PMSTA3904	*1Y

- [1] * = -: made in Hong Kong
 * = p: made in Hong Kong
 * = t: made in Malaysia
 * = W: made in China

5. Functional diagram

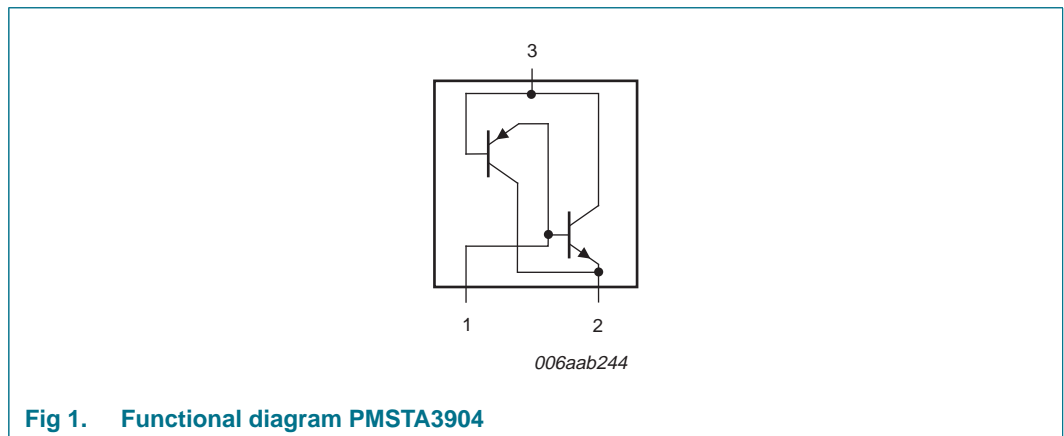

6. Limiting values

Table 5. Limiting values

In accordance with the Absolute Maximum Rating System (IEC 60134).

Symbol	Parameter	Conditions	Min	Max	Unit
V_{CBO}	collector-base voltage	open emitter	-	60	V
V_{CEO}	collector-emitter voltage	open base	-	40	V
V_{EBO}	emitter-base voltage	open collector	-	6	V
I_C	collector current		-	200	mA
I_{CR}	reverse collector current	open base	-	20	mA
I_{CM}	peak collector current	single pulse; $t_p \leq 1$ ms	-	200	mA
I_{BM}	peak base current	single pulse; $t_p \leq 1$ ms	-	100	mA
P_{tot}	total power dissipation	$T_{amb} \leq 25$ °C [1]	-	200	mW
T_j	junction temperature		-	150	°C
T_{amb}	ambient temperature		-65	+150	°C
T_{stg}	storage temperature		-65	+150	°C

[1] Device mounted on an FR4 Printed-Circuit Board (PCB), single-sided copper, tin-plated and standard footprint.

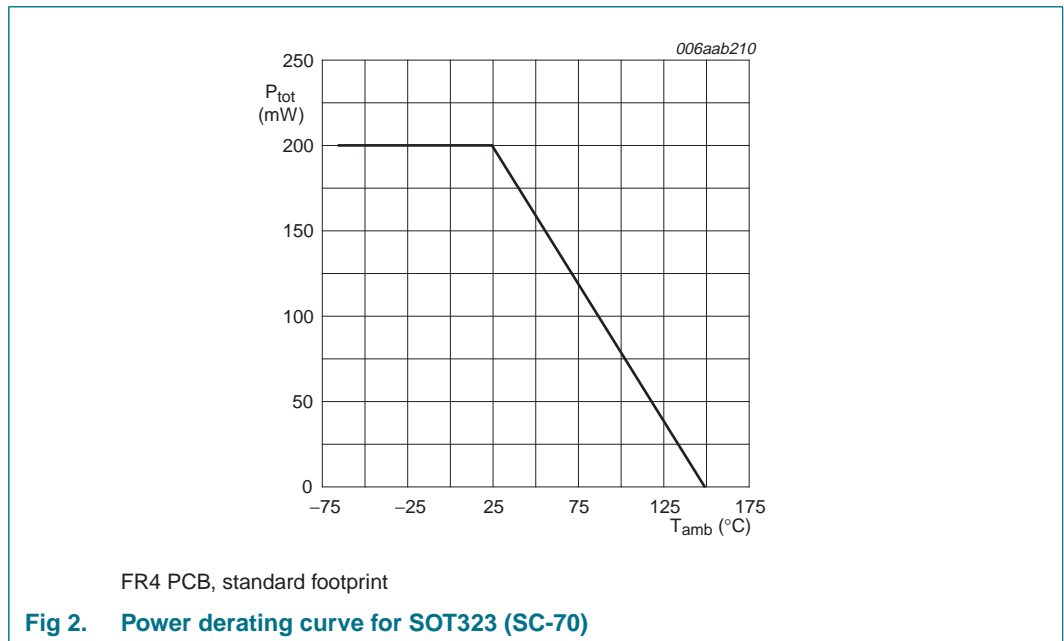

7. Thermal characteristics

Table 6. Thermal characteristics

Symbol	Parameter	Conditions	Min	Typ	Max	Unit
$R_{th(j-a)}$	thermal resistance from junction to ambient	in free air	[1]	-	625	K/W
$R_{th(j-sp)}$	thermal resistance from junction to solder point		-	-	175	K/W

[1] Device mounted on an FR4 PCB, single-sided copper, tin-plated and standard footprint.

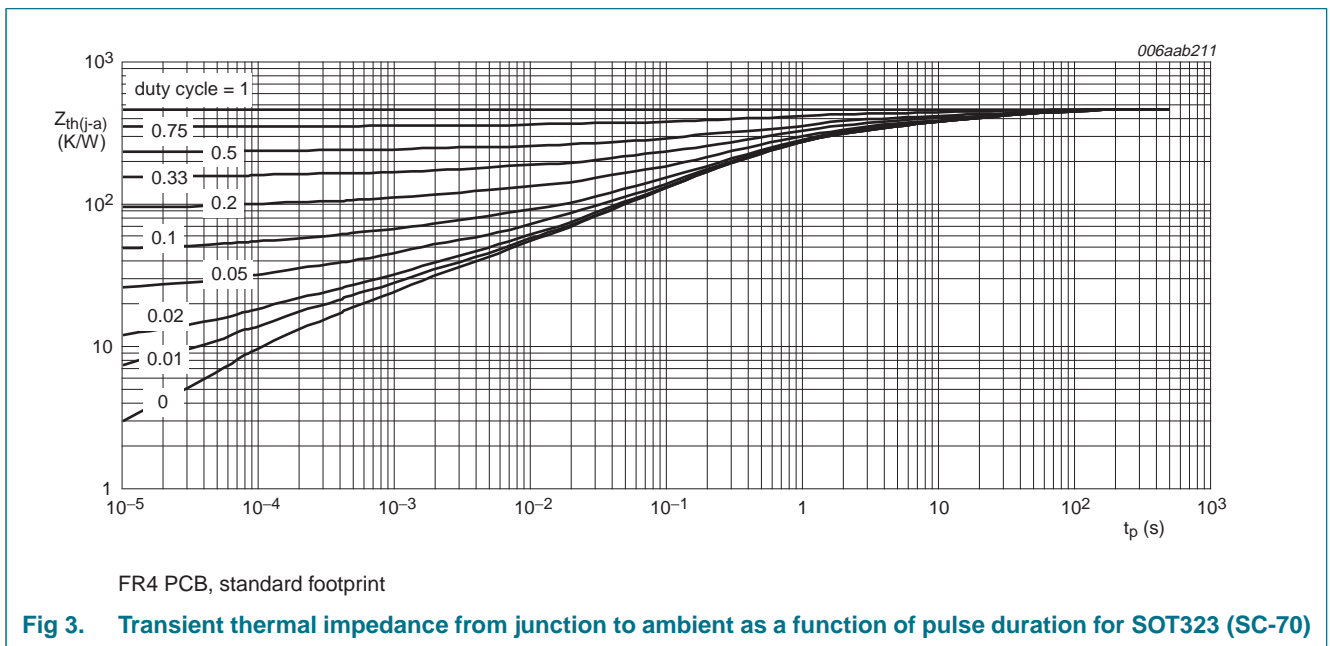

8. Characteristics

Table 7. Characteristics
T_{amb} = 25 °C unless otherwise specified.

Symbol	Parameter	Conditions	Min	Typ	Max	Unit
I _{CBO}	collector-base cut-off current	V _{CB} = 30 V; I _E = 0 A	-	-	50	nA
I _{EBO}	emitter-base cut-off current	V _{EB} = 6 V; I _C = 0 A	-	-	50	nA
h _{FE}	DC current gain	V _{CE} = 1 V				
		I _C = 0.1 mA	60	195	-	
		I _C = 1 mA	80	195	-	
		I _C = 10 mA	100	195	300	
		I _C = 50 mA	60	105	-	
V _{CEsat}	collector-emitter saturation voltage	I _C = 10 mA; I _B = 1 mA	-	75	200	mV
		I _C = 50 mA; I _B = 5 mA	-	120	300	mV
V _{ECO}	emitter-collector voltage	I _{CR} = 1 mA; I _B = 0 A	-	660	-	mV
V _{BEsat}	base-emitter saturation voltage	I _C = 10 mA; I _B = 1 mA	650	750	850	mV
		I _C = 50 mA; I _B = 5 mA	-	850	950	mV
f _T	transition frequency	V _{CE} = 20 V; I _C = 10 mA; f = 100 MHz	300	-	-	MHz
C _c	collector capacitance	V _{CB} = 5 V; I _E = I _e = 0 A; f = 1 MHz	-	-	4	pF
C _e	emitter capacitance	V _{BE} = 0.5 V; I _C = I _c = 0 A; f = 1 MHz	-	-	8	pF
NF	noise figure	V _{CE} = 5 V; I _C = 100 μA; R _S = 1 kΩ; f = 10 Hz to 15.7 kHz	-	-	5	dB
t _d	delay time	V _{CC} = 3 V;	-	-	35	ns
t _r	rise time	I _C = 10 mA;	-	-	35	ns
t _{on}	turn-on time	I _{Bon} = 1 mA; I _{Boff} = -1 mA	-	-	70	ns
t _s	storage time		-	-	200	ns
t _f	fall time		-	-	50	ns
t _{off}	turn-off time		-	-	250	ns

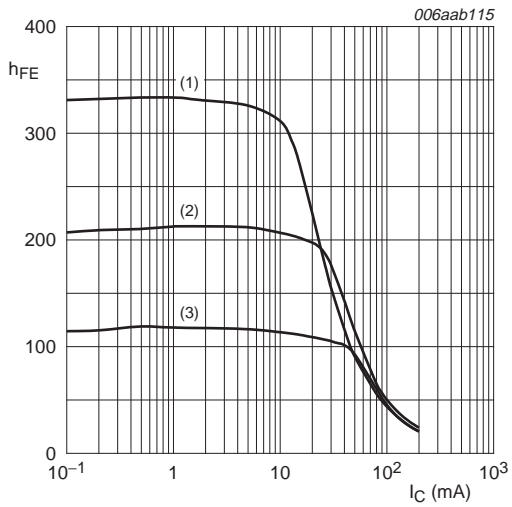

$V_{CE} = 1\text{ V}$
 (1) $T_{amb} = 150\text{ }^{\circ}\text{C}$
 (2) $T_{amb} = 25\text{ }^{\circ}\text{C}$
 (3) $T_{amb} = -55\text{ }^{\circ}\text{C}$

Fig 4. DC current gain as a function of collector current; typical values

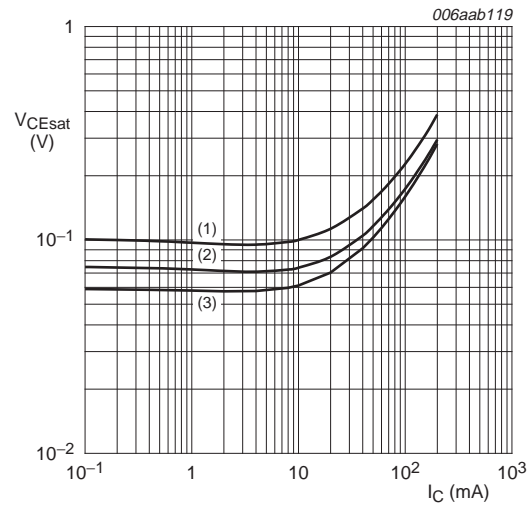

$I_C/I_B = 10$
 (1) $T_{amb} = 150\text{ }^{\circ}\text{C}$
 (2) $T_{amb} = 25\text{ }^{\circ}\text{C}$
 (3) $T_{amb} = -55\text{ }^{\circ}\text{C}$

Fig 5. Collector-emitter saturation voltage as a function of collector current; typical values

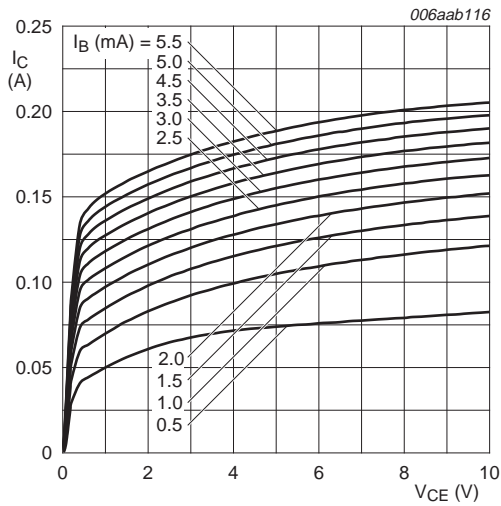

$T_{amb} = 25\text{ }^{\circ}\text{C}$

Fig 6. Collector current as a function of collector-emitter voltage; typical values

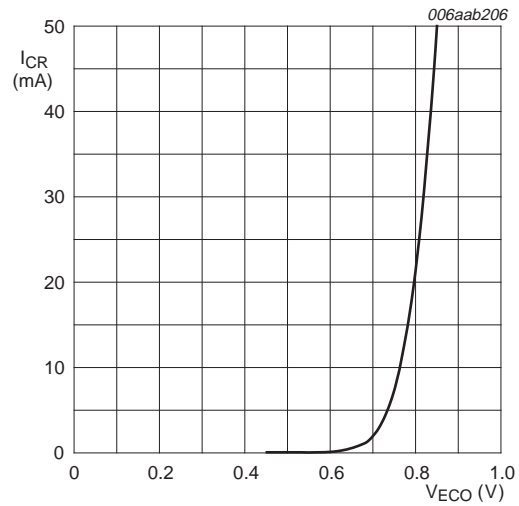

$I_B = 0\text{ A}; T_{amb} = 25\text{ }^{\circ}\text{C}$

Fig 7. Reverse collector current as a function of emitter-collector voltage; typical values

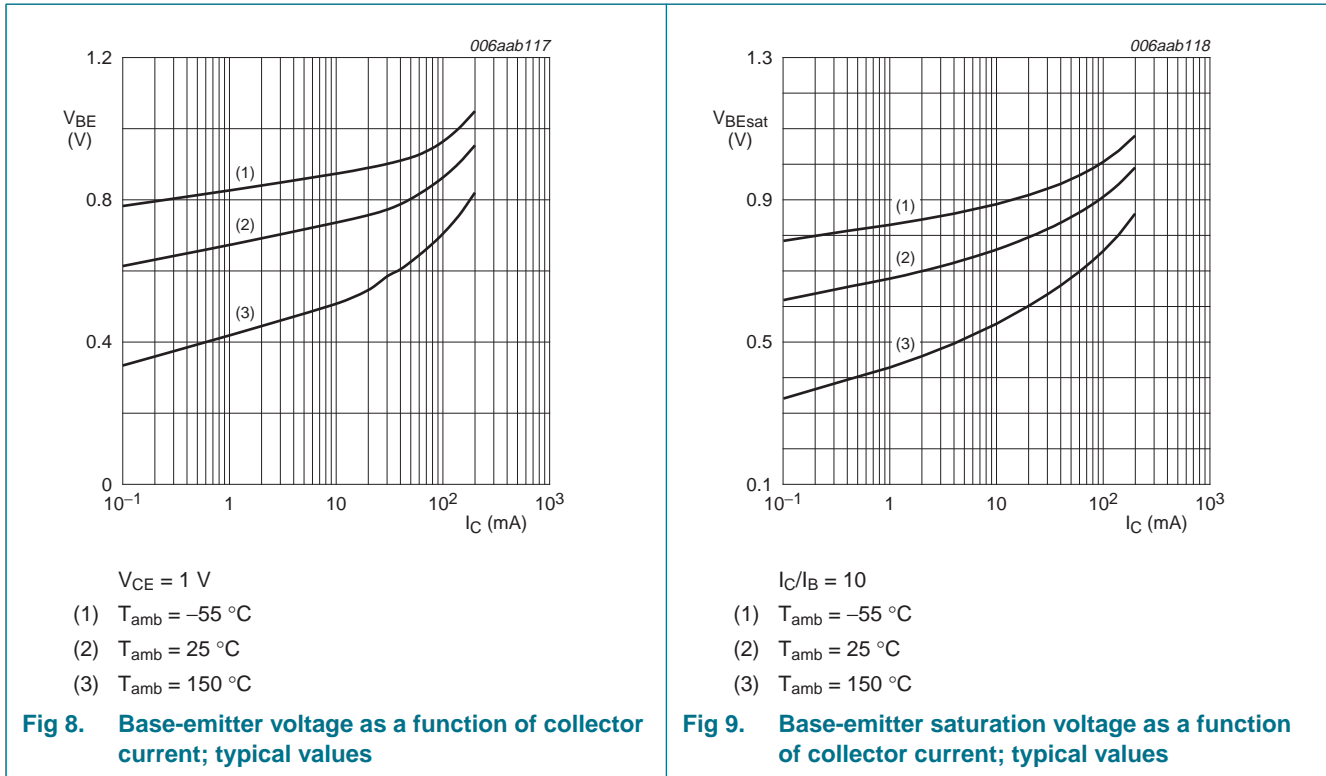

9. Test information

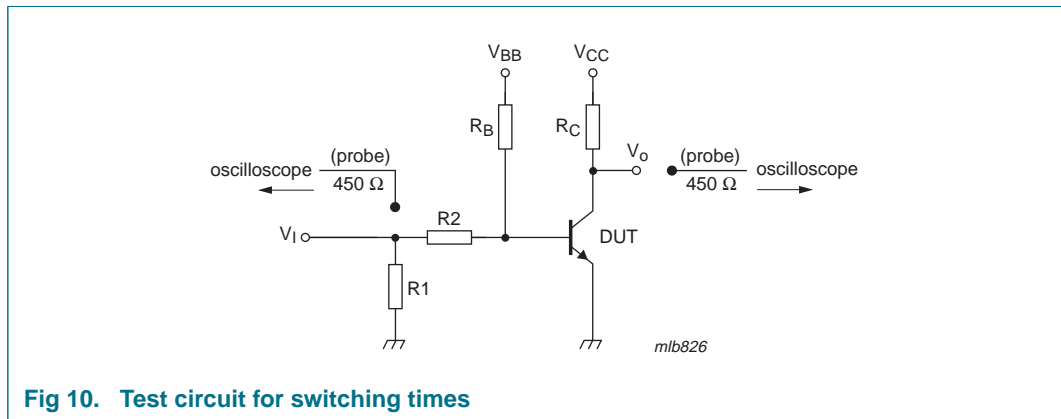

9.1 Quality information

This product has been qualified in accordance with the Automotive Electronics Council (AEC) standard *Q101 - Stress test qualification for discrete semiconductors*, and is suitable for use in automotive applications.

10. Package outline

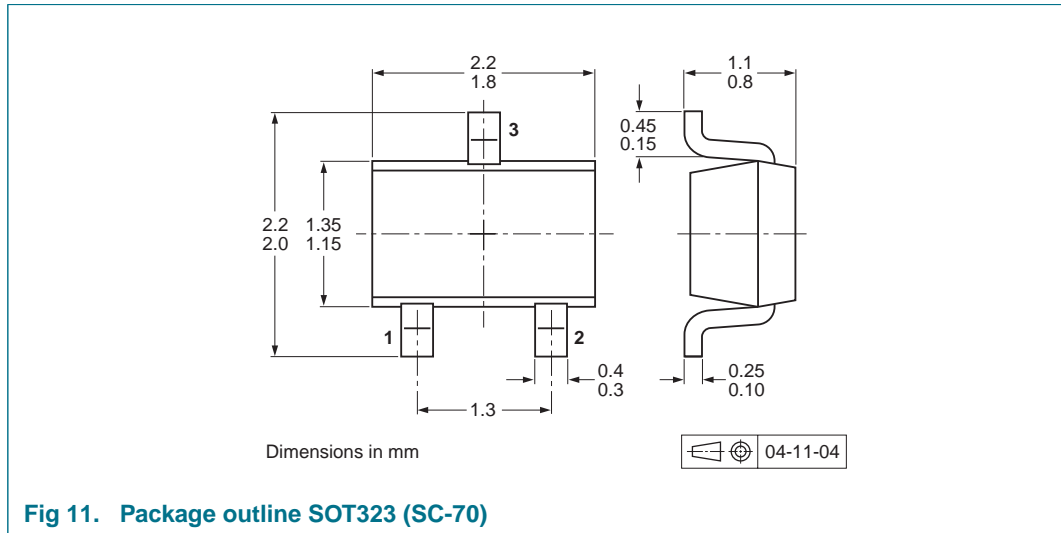

11. Packing information

Table 8. Packing methods

The indicated -xxx are the last three digits of the 12NC ordering code.^[1]

Type number	Package	Description	Packing quantity	
			3000	10000
PMSTA3904	SOT323	4 mm pitch, 8 mm tape and reel	-115	-135

[1] For further information and the availability of packing methods, see [Section 15](#).

12. Soldering

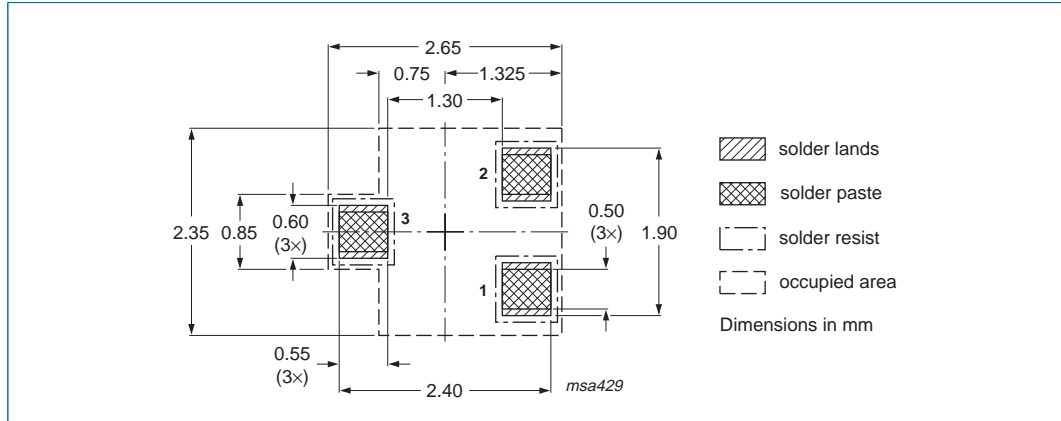

Fig 12. Reflow soldering footprint SOT323 (SC-70)

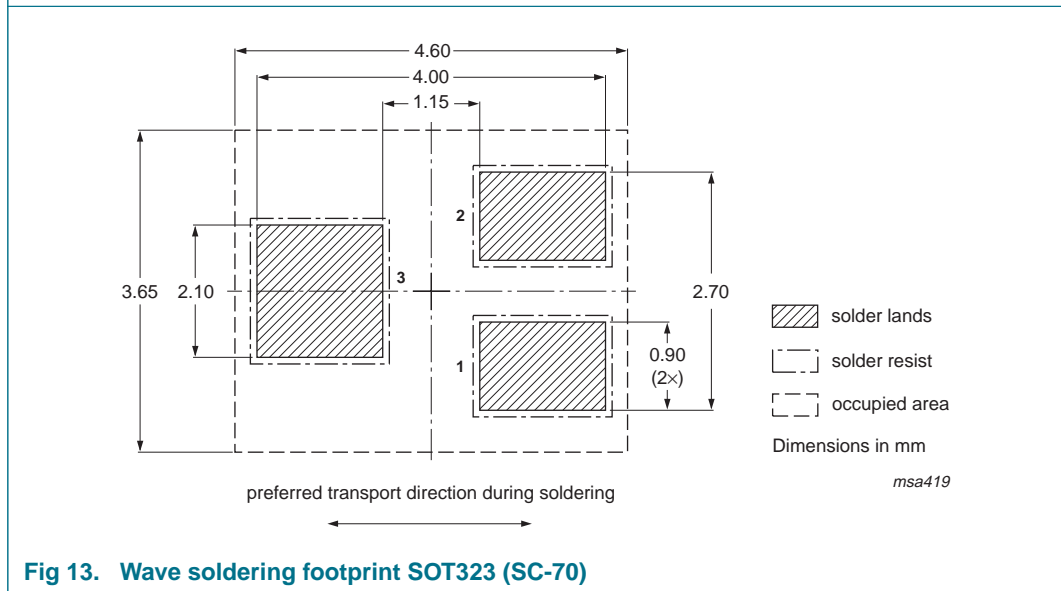

Fig 13. Wave soldering footprint SOT323 (SC-70)

13. Revision history

Table 9. Revision history

Document ID	Release date	Data sheet status	Change notice	Supersedes
PMSTA3904_1	20080421	Product data sheet	-	-

14. Legal information

14.1 Data sheet status

Document status ^{[1][2]}	Product status ^[3]	Definition
Objective [short] data sheet	Development	This document contains data from the objective specification for product development.
Preliminary [short] data sheet	Qualification	This document contains data from the preliminary specification.
Product [short] data sheet	Production	This document contains the product specification.

[1] Please consult the most recently issued document before initiating or completing a design.

[2] The term 'short data sheet' is explained in section "Definitions".

[3] The product status of device(s) described in this document may have changed since this document was published and may differ in case of multiple devices. The latest product status information is available on the Internet at URL <http://www.nxp.com>.

14.2 Definitions

Draft — The document is a draft version only. The content is still under internal review and subject to formal approval, which may result in modifications or additions. NXP Semiconductors does not give any representations or warranties as to the accuracy or completeness of information included herein and shall have no liability for the consequences of use of such information.

Short data sheet — A short data sheet is an extract from a full data sheet with the same product type number(s) and title. A short data sheet is intended for quick reference only and should not be relied upon to contain detailed and full information. For detailed and full information see the relevant full data sheet, which is available on request via the local NXP Semiconductors sales office. In case of any inconsistency or conflict with the short data sheet, the full data sheet shall prevail.

14.3 Disclaimers

General — Information in this document is believed to be accurate and reliable. However, NXP Semiconductors does not give any representations or warranties, expressed or implied, as to the accuracy or completeness of such information and shall have no liability for the consequences of use of such information.

Right to make changes — NXP Semiconductors reserves the right to make changes to information published in this document, including without limitation specifications and product descriptions, at any time and without notice. This document supersedes and replaces all information supplied prior to the publication hereof.

Suitability for use — NXP Semiconductors products are not designed, authorized or warranted to be suitable for use in medical, military, aircraft, space or life support equipment, nor in applications where failure or malfunction of an NXP Semiconductors product can reasonably be expected to result in personal injury, death or severe property or environmental

damage. NXP Semiconductors accepts no liability for inclusion and/or use of NXP Semiconductors products in such equipment or applications and therefore such inclusion and/or use is at the customer's own risk.

Applications — Applications that are described herein for any of these products are for illustrative purposes only. NXP Semiconductors makes no representation or warranty that such applications will be suitable for the specified use without further testing or modification.

Limiting values — Stress above one or more limiting values (as defined in the Absolute Maximum Ratings System of IEC 60134) may cause permanent damage to the device. Limiting values are stress ratings only and operation of the device at these or any other conditions above those given in the Characteristics sections of this document is not implied. Exposure to limiting values for extended periods may affect device reliability.

Terms and conditions of sale — NXP Semiconductors products are sold subject to the general terms and conditions of commercial sale, as published at <http://www.nxp.com/profile/terms>, including those pertaining to warranty, intellectual property rights infringement and limitation of liability, unless explicitly otherwise agreed to in writing by NXP Semiconductors. In case of any inconsistency or conflict between information in this document and such terms and conditions, the latter will prevail.

No offer to sell or license — Nothing in this document may be interpreted or construed as an offer to sell products that is open for acceptance or the grant, conveyance or implication of any license under any copyrights, patents or other industrial or intellectual property rights.

Quick reference data — The Quick reference data is an extract of the product data given in the Limiting values and Characteristics sections of this document, and as such is not complete, exhaustive or legally binding.

14.4 Trademarks

Notice: All referenced brands, product names, service names and trademarks are the property of their respective owners.

15. Contact information

For more information, please visit: <http://www.nxp.com>

For sales office addresses, please send an email to: salesaddresses@nxp.com

16. Contents

1 Product profile 1

1.1 General description 1

1.2 Features 1

1.3 Applications 1

1.4 Quick reference data 1

2 Pinning information 1

3 Ordering information 2

4 Marking 2

5 Functional diagram 2

6 Limiting values 3

7 Thermal characteristics 4

8 Characteristics 5

9 Test information 7

9.1 Quality information 7

10 Package outline 8

11 Packing information 8

12 Soldering 9

13 Revision history 10

14 Legal information 11

14.1 Data sheet status 11

14.2 Definitions 11

14.3 Disclaimers 11

14.4 Trademarks 11

15 Contact information 11

16 Contents 12

Please be aware that important notices concerning this document and the product(s) described herein, have been included in section 'Legal information'.

