

PB Series Single Pole and Multi-Key Pushbutton Switches



A

Pushbutton

Features/Benefits

- Momentary or latching options
- Reliable contact design
- 2, 4, and 6 pole configurations
- Long travel and extended life cycles

Typical Applications

- Appliances
- Audio and visual equipment
- Consumer electronics
- Industrial equipment



Specifications

CONTACT RATING: 0.3A @ 30 VDC
 INITIAL CONTACT RESISTANCE: 30 m ohms max.
 INSULATION RESISTANCE: 100 M ohms min.
 DIELECTRIC STRENGTH: 500 V AC (50-60 Hz) between open terminals and between the frame and terminal.
 OPERATING LIFE: 10,000 cycles without load
 OPERATING FORCE:
 250 ± 100 gf (2.45 ± 0.98N)
 LOCK TRAVEL: 2 ± 0.3 mm
 TOTAL TRAVEL: 3 ± 0.3 mm
 OPERATING TEMPERATURE: -20°C to 70°C

Materials

CASE: PC (UL 94HB)
 PLASTIC CLIP: POM (UL 94HB)
 SPRING: SUS
 KNOB: POM
 TERMINAL: Silver plated

PB-22D01-L 2PDT LOCK / LATCHING

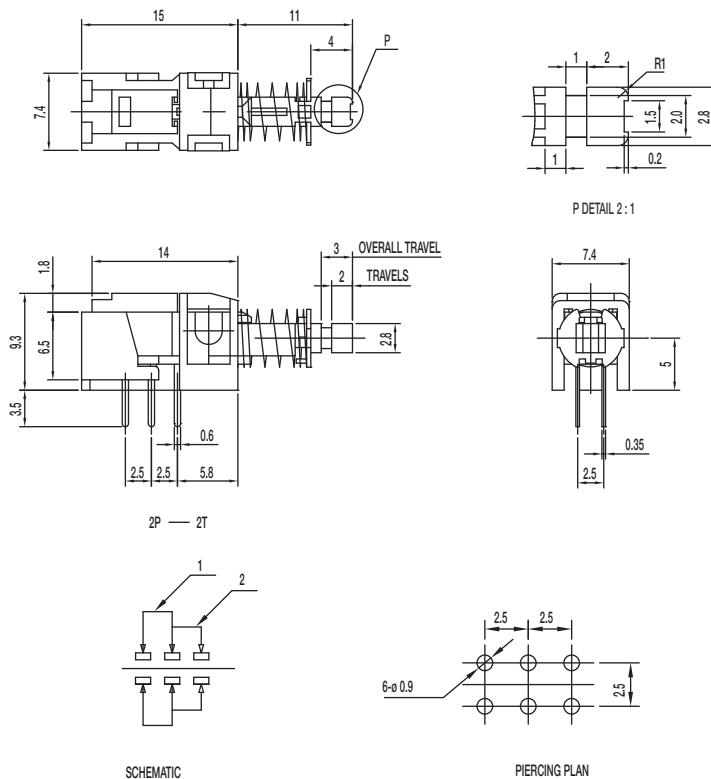

Dimensions are shown: mm
 Specifications and dimensions subject to change



PB Series Single Pole and Multi-Key Pushbutton Switches

PB-42D01-L 4PDT LOCK / LATCHING

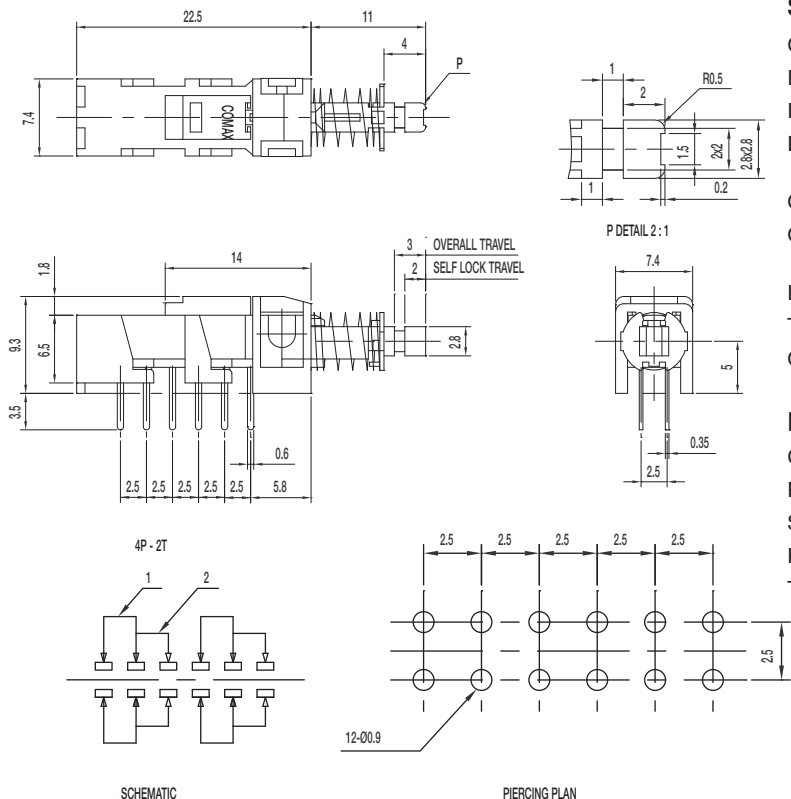

Specifications

- CONTACT RATING: 0.3A @ 30 VDC
- INITIAL CONTACT RESISTANCE: 30 m ohms max.
- INSULATION RESISTANCE: 100 M ohms min.
- DIELECTRIC STRENGTH: 500 V AC (50-60 Hz) between open terminals and between the frame and terminal.
- OPERATING LIFE: 10,000 cycles without load
- OPERATING FORCE: 280 ± 100 gf
- LOCK TRAVEL: 2 ± 0.3 mm
- TOTAL TRAVEL: 3 ± 0.3 mm
- OPERATING TEMPERATURE: -20°C to 70°C

Materials

- CASE: PC (UL 94HB)
- PLASTIC CLIP: POM (UL 94HB)
- SPRING: SUS
- KNOB: POM
- TERMINAL: Silver plated

PB-62D01-L 6PDT LOCK / LATCHING

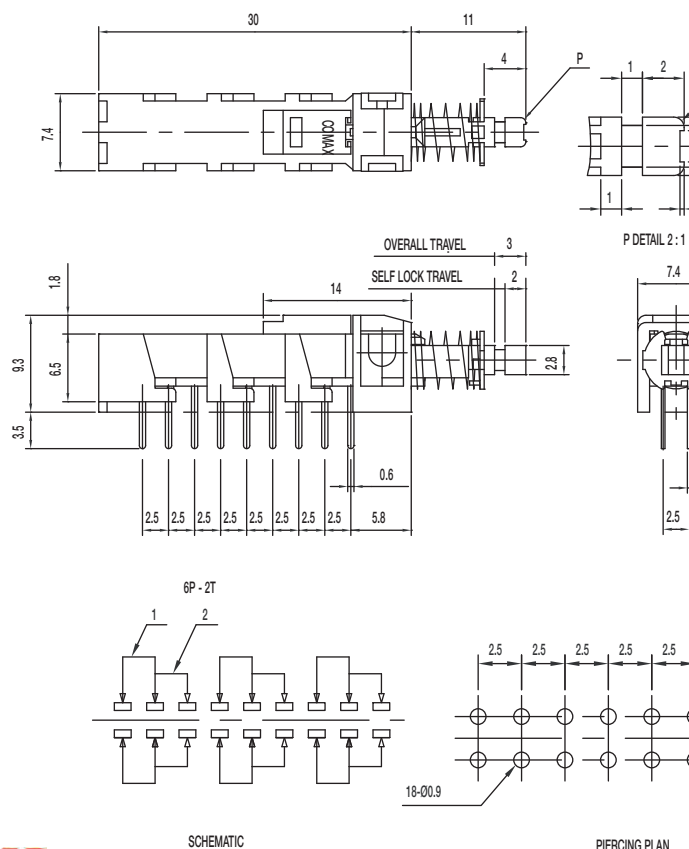

Specifications

- CONTACT RATING: 0.3A @ 30 VDC
- INITIAL CONTACT RESISTANCE: 30 m ohms max.
- INSULATION RESISTANCE: 100 M ohms min.
- DIELECTRIC STRENGTH: 500 V AC (50-60 Hz) between open terminals and between the frame and terminal.
- OPERATING LIFE: 10,000 cycles without load
- OPERATING FORCE: 300 ± 100 gf (2.94 ± 0.98N)
- LOCK TRAVEL: 2 ± 0.3 mm
- TOTAL TRAVEL: 3 ± 0.3 mm
- OPERATING TEMPERATURE: -20°C to 70°C

Materials

- CASE: PC (UL 94HB)
- PLASTIC CLIP: POM (UL 94HB)
- SPRING: SUS
- KNOB: POM
- TERMINAL: Silver plated



Dimensions are shown: mm
Specifications and dimensions subject to change

PB Series Single Pole and Multi-Key Pushbutton Switches



A

Pushbutton

PB-22D01-F 2PDT NON-LOCK / MOMENTARY

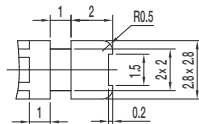
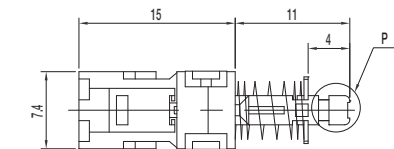

P DETAIL 2:1

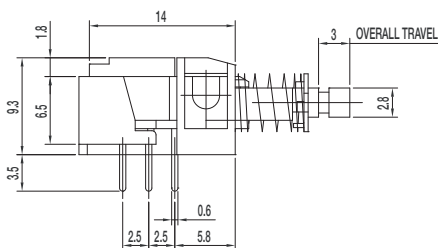

2P - 2T

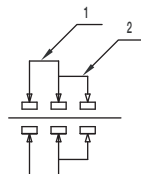
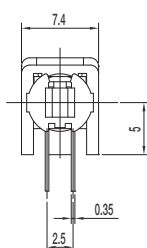

SCHEMATIC

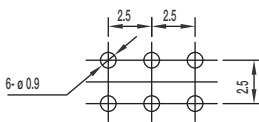

PIERCING PLAN

Specifications

CONTACT RATING: 0.3A @ 30 VDC
 INITIAL CONTACT RESISTANCE: 30 m ohms max.
 INSULATION RESISTANCE: 100 M ohms min.
 DIELECTRIC STRENGTH: 500 V AC (50-60 Hz) between open terminals and between the frame and terminal.
 OPERATING LIFE: 10,000 cycles without load
 OPERATING FORCE:
 250 ± 100 gf (2.45 ± 0.98 N)
 TOTAL TRAVEL: 3 ± 0.3 mm
 OPERATING TEMPERATURE: -20°C to 70°C

Materials

CASE: PC (UL 94HB)
 PLASTIC CLIP: POM (UL 94HB)
 SPRING: SUS
 KNOB: POM
 TERMINAL: Silver plated

PB-42D01-F 4PDT NON-LOCK / MOMENTARY

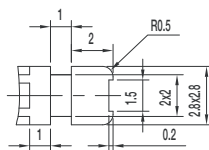

P DETAIL 2:1

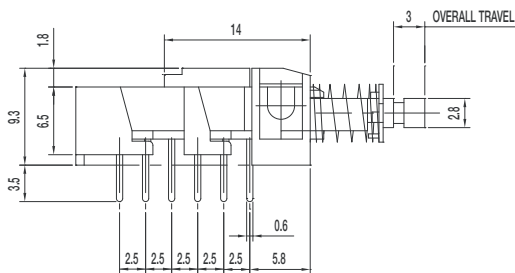

4P - 2T

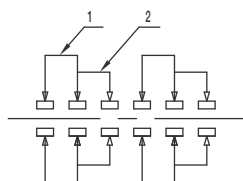
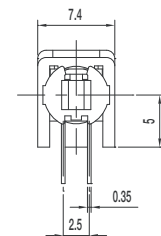

SCHEMATIC

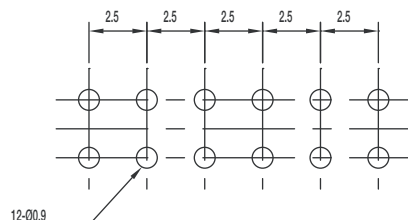

PIERCING PLAN

Specifications

CONTACT RATING: 0.3A @ 30 VDC
 INITIAL CONTACT RESISTANCE: 30 m ohms max.
 INSULATION RESISTANCE: 100 M ohms min.
 DIELECTRIC STRENGTH: 500 V AC (50-60 Hz) between open terminals and between the frame and terminal.
 OPERATING LIFE: 10,000 cycles without load
 OPERATING FORCE:
 280 ± 100 gf (2.477 ± 0.98 N)
 TOTAL TRAVEL: 3 ± 0.3 mm
 OPERATING TEMPERATURE: -20°C to 70°C

Materials

CASE: PC (UL 94HB)
 PLASTIC CLIP: POM (UL 94HB)
 SPRING: SUS
 KNOB: POM
 TERMINAL: Silver plated



Dimensions are shown: mm
 Specifications and dimensions subject to change



PB Series Single Pole and Multi-Key Pushbutton Switches

PB-62D01-F 6PDT NON-LOCK / MOMENTARY

Pushbutton
A

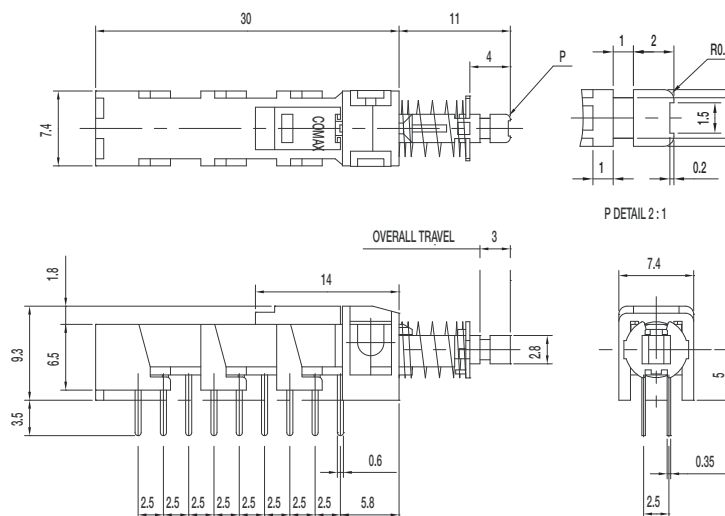

Specifications

- CONTACT RATING: 0.3A @ 30 VDC
- INITIAL CONTACT RESISTANCE: 30 m ohms max.
- INSULATION RESISTANCE: 100 M ohms min.
- DIELECTRIC STRENGTH: 500 V AC (50-60 Hz) between open terminals and between the frame and terminal.
- OPERATING LIFE: 10,000 cycles without load
- OPERATING FORCE:
300 ± 100 gf (2.94 ± 0.98N)
- TOTAL TRAVEL: 3 ± 0.3 mm
- OPERATING TEMPERATURE: -20°C to 70°C

Materials

- CASE: PC (UL 94HB)
- PLASTIC CLIP: POM (UL 94HB)
- SPRING: SUS
- KNOB: POM
- TERMINAL: Silver plated

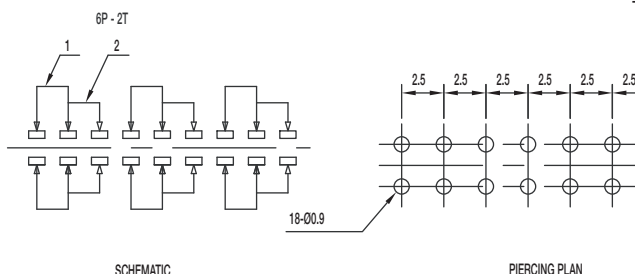

SCHEMATIC

PIERCING PLAN

PB-22G02-L 2PDT LOCK / LATCHING

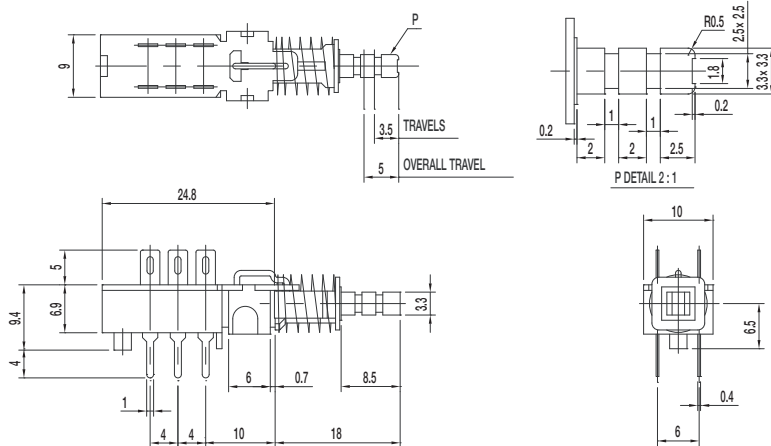

Specifications

- CONTACT RATING: 1A @ 25 VDC
- INITIAL CONTACT RESISTANCE: 30 m ohms max.
- INSULATION RESISTANCE: 100 M ohms min.
- DIELECTRIC STRENGTH: 500 V AC (50-60 Hz) between open terminals and between the frame and terminal.
- OPERATING LIFE: 10,000 cycles without load
- OPERATING FORCE:
350 ± 150 gf (3.43 ± 1.47N)
- LOCK TRAVEL: 3.5 ± 0.3mm
- TOTAL TRAVEL: 5 ± 0.3 mm
- OPERATING TEMPERATURE: -20°C to 70°C

Materials

- CASE: PC (UL 94HB)
- SPRING: SUS
- KNOB: POM
- TERMINAL: Silver plated

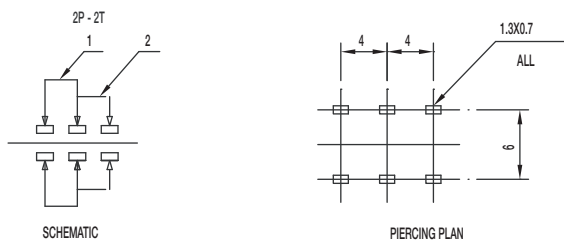

SCHEMATIC

PIERCING PLAN



Dimensions are shown: mm
Specifications and dimensions subject to change



PB Series Single Pole and Multi-Key Pushbutton Switches

PB-22G02-F DPDT NON-LOCK / MOMENTARY

Pushbutton
A

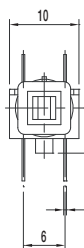
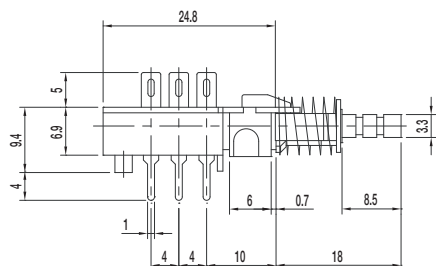
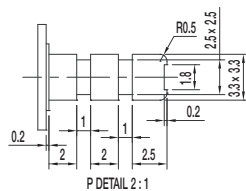
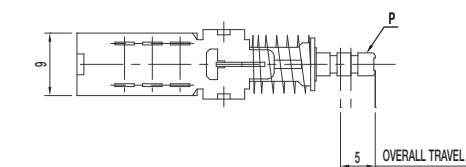

Specifications

- CONTACT RATING: 1A @ 25 VDC
- INITIAL CONTACT RESISTANCE: 30 m ohms max.
- INSULATION RESISTANCE: 100 M ohms min.
- DIELECTRIC STRENGTH: 500 V AC (50-60 Hz) between open terminals and between the frame and terminal.
- OPERATING LIFE: 10,000 cycles without load
- OPERATING FORCE:
350 ± 150 gf (3.43 ± 1.47N)
- TOTAL TRAVEL: 5 ± 0.3 mm
- OPERATING TEMPERATURE: -20°C to 70°C

Materials

- CASE: PC (UL 94HB)
- SPRING: SUS
- KNOB: POM
- TERMINAL: Silver plated

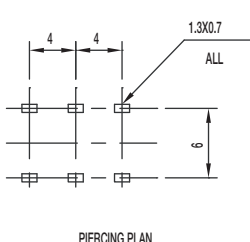
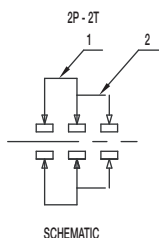

PB-42G02-F 4PDT NON-LOCK / MOMENTARY

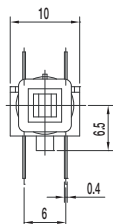
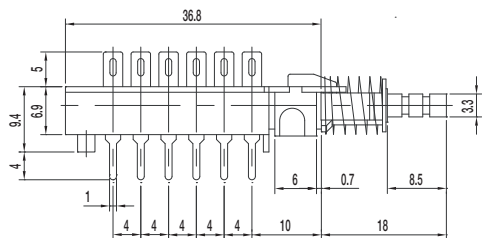
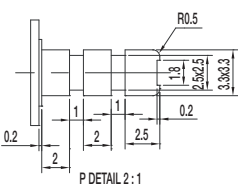
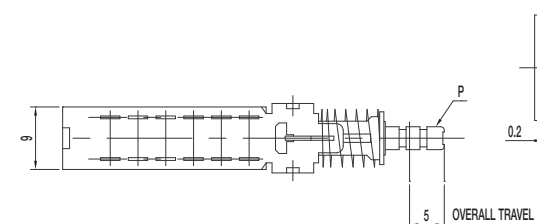

Specifications

- CONTACT RATING: 1A @ 25 VDC
- INITIAL CONTACT RESISTANCE: 30 m ohms max.
- INSULATION RESISTANCE: 100 M ohms min.
- DIELECTRIC STRENGTH: 500 V AC (50-60 Hz) between open terminals and between the frame and terminal.
- OPERATING LIFE: 10,000 cycles without load
- OPERATING FORCE:
400 ± 150 gf (3.92 ± 1.47N)
- TOTAL TRAVEL: 5 ± 0.3 mm
- OPERATING TEMPERATURE: -20°C to 70°C

Materials

- HOUSING: PC (UL 94HB)
- SPRING: SUS
- KNOB: POM
- TERMINAL: Silver plated

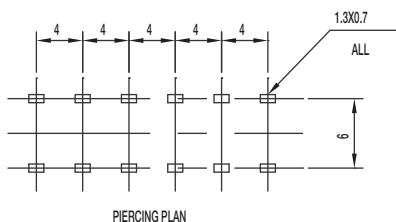
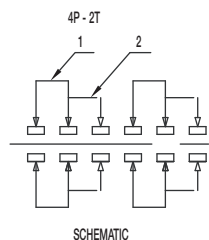

Dimensions are shown: mm
Specifications and dimensions subject to change

