

**Product Summary**

- $V_R = 40V$
- $I_F = 500mA$
- $I_R = 40\mu A$

**Applications**

- DC – DC Converters
- Mobile Telecomms
- PCMIA

**Features**

- High Current Capability ( $I_F = 500mA$ )
- Low  $V_F$
- **Lead-Free Finish; RoHS Compliant (Notes 1 & 2)**
- **Halogen and Antimony Free. "Green" Device (Note 3)**
- **Qualified to AEC-Q101 Standards for High Reliability**

**Mechanical Data**

- Case: SOT23
- Case Material: Molded Plastic, "Green" Molding Compound. UL Flammability Classification Rating 94V-0
- Moisture Sensitivity: Level 1 per J-STD-020
- Terminals: Matte Tin Finish annealed over Alloy 42 leadframe (Lead Free Plating). Solderable per MIL-STD-202, Method 208 **e3**
- Weight: 0.0089 grams (approximate)



**Ordering Information** (Note 4)

Part Number	Case	Packaging
ZHCS500TA	SOT23	3000/Tape & Reel
ZHCS500QTA	SOT23	3000/Tape & Reel

- Notes:
1. EU Directive 2002/95/EC (RoHS) & 2011/65/EU (RoHS 2) compliant. All applicable RoHS exemptions applied.
  2. See <http://www.diodes.com> for more information about Diodes Incorporated's definitions of Halogen- and Antimony-free, "Green" and Lead-free.
  3. Halogen- and Antimony-free "Green" products are defined as those which contain <900ppm bromine, <900ppm chlorine (<1500ppm total Br + Cl) and <1000ppm antimony compounds.
  4. For Packaging Details, go to our website at <http://www.diodes.com>.

**Marking Information**

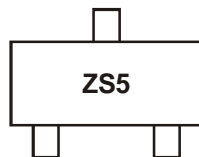

ZS5 = Product Type Marking Code

**Maximum Ratings** (@T<sub>A</sub> = +25°C, unless otherwise specified.)

Characteristic	Symbol	Value	Units
Continuous Reverse Voltage	V <sub>R</sub>	40	V
Continuous Forward Current	I <sub>F</sub>	500	mA
Forward Voltage @ I <sub>F</sub> = 500mA	V <sub>F</sub>	550	mV
Average Peak Forward Current; D.C. = 50%	I <sub>FAV</sub>	1000	mA
Non Repetitive Forward Current	I <sub>FSM</sub>	t ≤ 100μs	6.75 A
		t ≤ 10ms	3 A

**Thermal Characteristics**

Characteristic	Symbol	Value	Unit
Power Dissipation, T <sub>A</sub> = +25°C	P <sub>D</sub>	330	mW
Junction Temperature	T <sub>J</sub>	125	°C
Storage Temperature Range	T <sub>STG</sub>	-55 to +150	°C

**Electrical Characteristics** (@T<sub>A</sub> = +25°C, unless otherwise specified.)

Characteristic	Symbol	Min	Typ	Max	Unit	Test Condition
Reverse Breakdown Voltage	V <sub>(BR)R</sub>	40	60	—	V	I <sub>R</sub> = 200μA
Forward Voltage (Note 5)	V <sub>F</sub>	—	270	300	mV	I <sub>F</sub> = 50mA
		—	300	350		I <sub>F</sub> = 100mA
		—	370	460		I <sub>F</sub> = 250mA
		—	465	550		I <sub>F</sub> = 500mA
		—	550	670		I <sub>F</sub> = 750mA
		—	640	780		I <sub>F</sub> = 1A
		—	810	1050		I <sub>F</sub> = 1.5A
		—	440	—		I <sub>F</sub> = 500mA, T <sub>A</sub> = +100°C
Reverse Current	I <sub>R</sub>	—	15	40	μA	V <sub>R</sub> = 30V
Diode Capacitance	C <sub>D</sub>	—	20	—	pF	f = 1MHz, V <sub>R</sub> = 25V
Reverse Recovery Time	t <sub>rr</sub>	—	10	—	ns	Switched from I <sub>F</sub> = 500mA to I <sub>R</sub> = 500mA Measured @ I <sub>R</sub> = 50mA

Notes: 5. Measured under pulsed conditions. Pulse width = 300μs. Duty cycle = 2%.

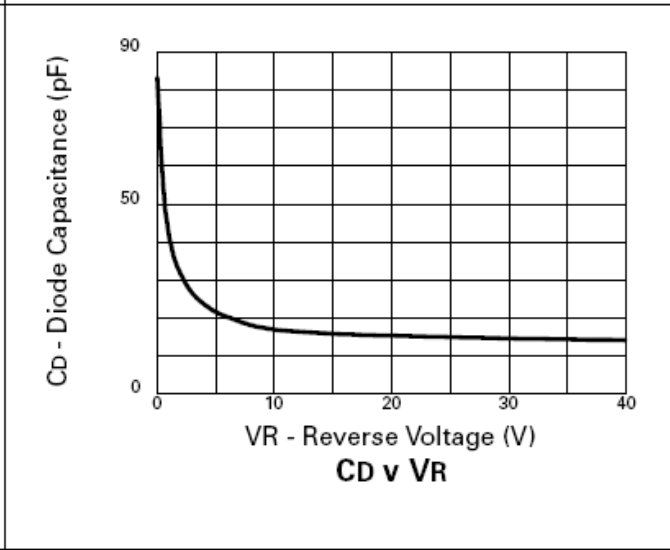
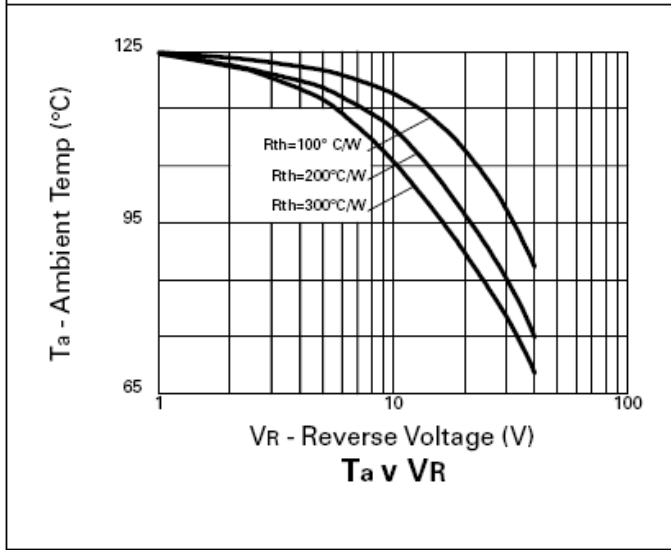
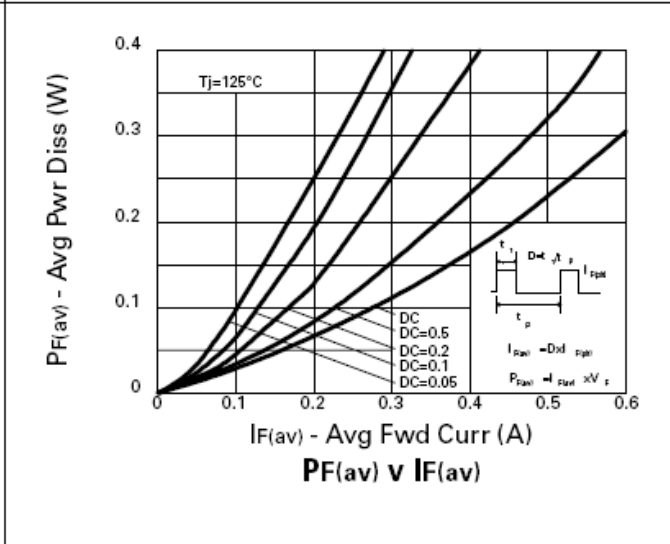
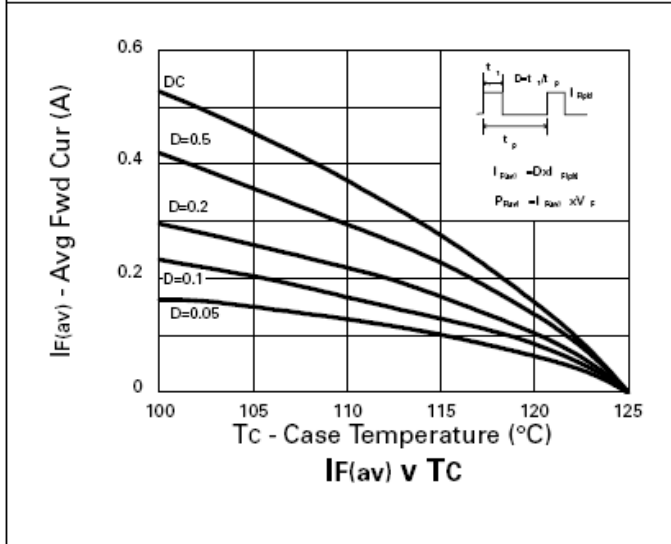
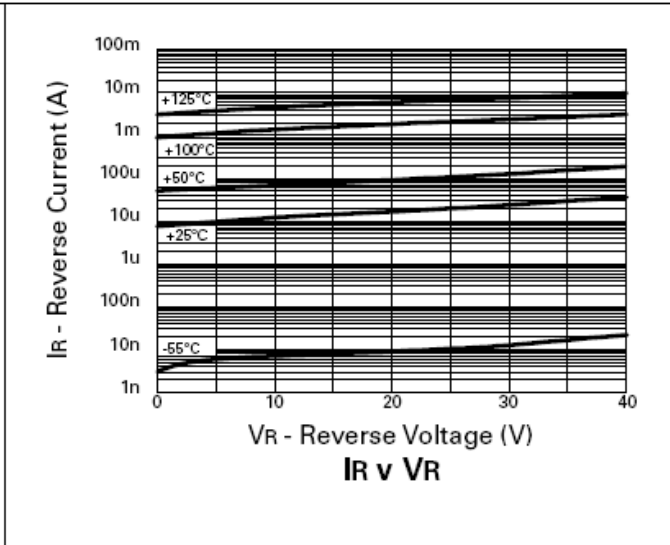
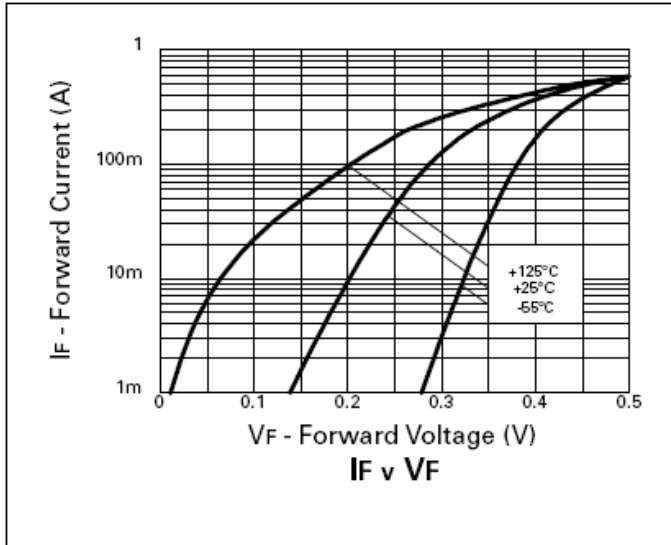

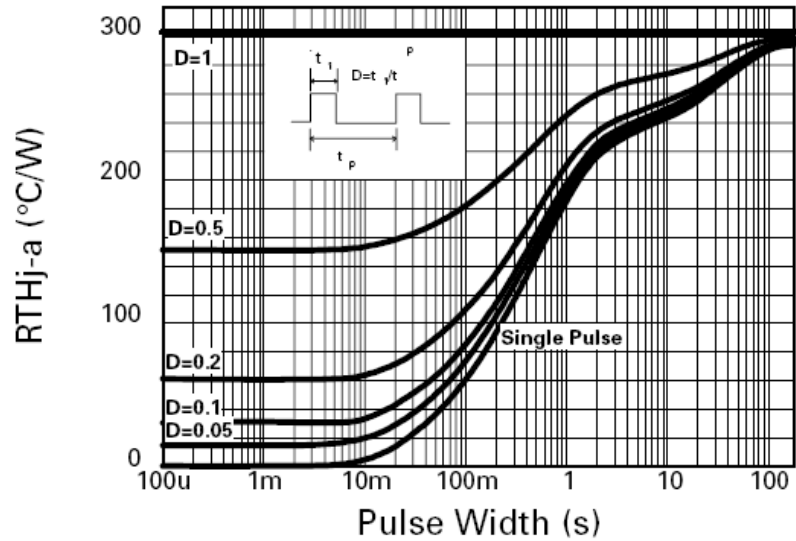

### Package Outline Dimensions

Please see AP02002 at <http://www.diodes.com/datasheets/ap02002.pdf> for latest version.

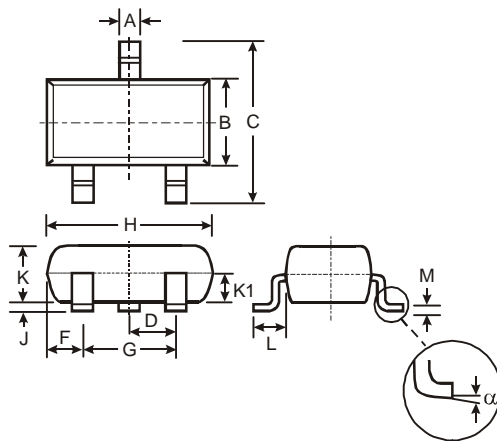

SOT23			
Dim	Min	Max	Typ
A	0.37	0.51	0.40
B	1.20	1.40	1.30
C	2.30	2.50	2.40
D	0.89	1.03	0.915
F	0.45	0.60	0.535
G	1.78	2.05	1.83
H	2.80	3.00	2.90
J	0.013	0.10	0.05
K	0.903	1.10	1.00
K1	-	-	0.400
L	0.45	0.61	0.55
M	0.085	0.18	0.11
$\alpha$	0 $^{\circ}$	8 $^{\circ}$	-
All Dimensions in mm			

### Suggested Pad Layout

Please see AP02001 at <http://www.diodes.com/datasheets/ap02001.pdf> for the latest version.

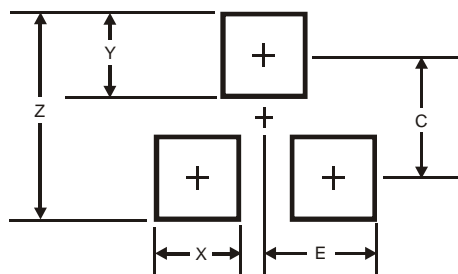

Dimensions	Value (in mm)
Z	2.9
X	0.8
Y	0.9
C	2.0
E	1.35

**IMPORTANT NOTICE**

DIODES INCORPORATED MAKES NO WARRANTY OF ANY KIND, EXPRESS OR IMPLIED, WITH REGARDS TO THIS DOCUMENT, INCLUDING, BUT NOT LIMITED TO, THE IMPLIED WARRANTIES OF MERCHANTABILITY AND FITNESS FOR A PARTICULAR PURPOSE (AND THEIR EQUIVALENTS UNDER THE LAWS OF ANY JURISDICTION).

Diodes Incorporated and its subsidiaries reserve the right to make modifications, enhancements, improvements, corrections or other changes without further notice to this document and any product described herein. Diodes Incorporated does not assume any liability arising out of the application or use of this document or any product described herein; neither does Diodes Incorporated convey any license under its patent or trademark rights, nor the rights of others. Any Customer or user of this document or products described herein in such applications shall assume all risks of such use and will agree to hold Diodes Incorporated and all the companies whose products are represented on Diodes Incorporated website, harmless against all damages.

Diodes Incorporated does not warrant or accept any liability whatsoever in respect of any products purchased through unauthorized sales channel. Should Customers purchase or use Diodes Incorporated products for any unintended or unauthorized application, Customers shall indemnify and hold Diodes Incorporated and its representatives harmless against all claims, damages, expenses, and attorney fees arising out of, directly or indirectly, any claim of personal injury or death associated with such unintended or unauthorized application.

Products described herein may be covered by one or more United States, international or foreign patents pending. Product names and markings noted herein may also be covered by one or more United States, international or foreign trademarks.

This document is written in English but may be translated into multiple languages for reference. Only the English version of this document is the final and determinative format released by Diodes Incorporated.

**LIFE SUPPORT**

Diodes Incorporated products are specifically not authorized for use as critical components in life support devices or systems without the express written approval of the Chief Executive Officer of Diodes Incorporated. As used herein:

A. Life support devices or systems are devices or systems which:

1. are intended to implant into the body, or
2. support or sustain life and whose failure to perform when properly used in accordance with instructions for use provided in the labeling can be reasonably expected to result in significant injury to the user.

B. A critical component is any component in a life support device or system whose failure to perform can be reasonably expected to cause the failure of the life support device or to affect its safety or effectiveness.

Customers represent that they have all necessary expertise in the safety and regulatory ramifications of their life support devices or systems, and acknowledge and agree that they are solely responsible for all legal, regulatory and safety-related requirements concerning their products and any use of Diodes Incorporated products in such safety-critical, life support devices or systems, notwithstanding any devices- or systems-related information or support that may be provided by Diodes Incorporated. Further, Customers must fully indemnify Diodes Incorporated and its representatives against any damages arising out of the use of Diodes Incorporated products in such safety-critical, life support devices or systems.

Copyright © 2012, Diodes Incorporated

[www.diodes.com](http://www.diodes.com)