

50x50x15 mm

10.2~17.0 CFM



■ Specifications

	Bearing	Rating Voltage	Power Current	Power Consumption	Speed	Air Flow	Static Pressure	Noise	Weight	Curve
	● VAPO	(VDC)	(mA)	(WATTS)	(RPM)	(CFM)	(Inch-H ₂ O)	(dB(A))	(g)	
MB50151V1-000U-A99	●	12	87	1.05	5800	17.0	0.23	33.0	38.8	1
MB50151V2-000U-A99	●	12	54	0.65	4700	13.0	0.17	29.0	38.8	2
MB50151V3-000U-A99	●	12	35	0.42	3700	10.2	0.12	22.0	38.8	3
MB50152V1-000U-A99	●	24	55	1.32	5800	17.0	0.23	33.0	37.8	1
MB50152V2-000U-A99	●	24	35	0.84	4700	13.0	0.17	29.0	37.8	2

■ Air Flow-Static Pressure Characteristics

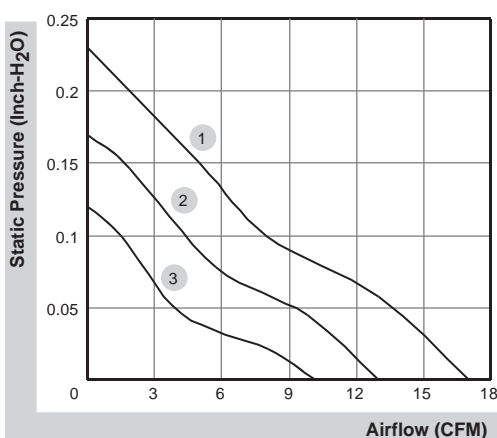

■ External dimensions(mm)

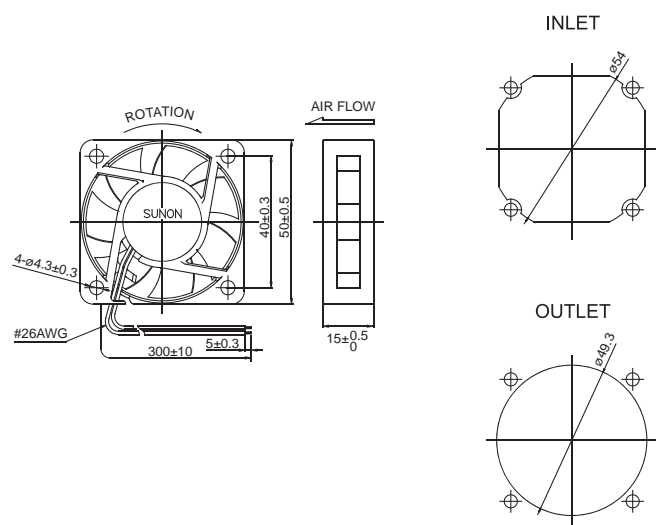

*All model could be customized. Please contact with Sunon Sales.

*Specifications are subject to change without notice. Please Visit SUNON website at <http://www.sunon.com> for update information.