

FDR6580

N-Chennal 2.5V Specified PowerTrench™ MOSFET

General Description

This N-Channel 2.5V specified MOSFET is produced using Fairchild Semiconductor's advanced PowerTrench process that has been especially tailored to minimize the on-state resistance and yet maintain low gate charge for superior switching performance.

Applications

- Load switch
- Motor driving
- Power Management

Features

- 11 A, 20 V. $R_{DS(ON)} = 0.009 \Omega @ V_{GS} = 4.5 \text{ V}$
 $R_{DS(ON)} = 0.013 \Omega @ V_{GS} = 2.5 \text{ V}$.
- Low gate charge.
- High performance trench technology for extremely low $R_{DS(ON)}$.
- Small footprint (38% smaller than a standard SO-8); low profile package (1 mm thick); power handling capability similar to SO-8.

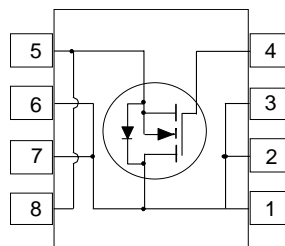
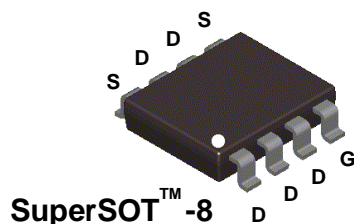

Absolute Maximum Ratings T_A = 25°C unless otherwise noted

Symbol	Parameter	Ratings	Units
V _{DSS}	Drain-Source Voltage	20	V
V _{GSS}	Gate-Source Voltage	±8	V
I _D	Drain Current - Continuous (Note 1a) - Pulsed	11	A
		50	
P _D	Power Dissipation for Single Operation (Note 1a) (Note 1b) (Note 1c)	1.8	W
		1.0	
		0.9	
T _J , T _{stg}	Operating and Storage Junction Temperature Range	-55 to +150	°C

Thermal Characteristics

R _{θJA}	Thermal Resistance, Junction-to-Ambient (Note 1a)	70	°C/W
R _{θJC}	Thermal Resistance, Junction-to-Case (Note 1)	20	°C/W

Package Outlines and Ordering Information

Device Marking	Device	Reel Size	Tape Width	Quantity
.6580	FDR6580	13"	12mm	3000 units

Electrical Characteristics T_A=25°C unless otherwise noted

Symbol	Parameter	Test Conditions	Min	Typ	Max	Units
--------	-----------	-----------------	-----	-----	-----	-------

OFF CHARACTERISTICS

BV _{DSS}	Drain-Source Breakdown Voltage	V _{GS} = 0 V, I _D = 250 μA	20			V
I _{DSS}	Zero Gate Voltage Drain Current	V _{DS} = 16 V, V _{GS} = 0 V			1	μA
I _{GSSF}	Gate-Body Leakage, Forward	V _{GS} = 8 V, V _{DS} = 0 V			10	μA
I _{GSSR}	Gate-Body Leakage, Reverse	V _{GS} = -8 V, V _{DS} = 0 V			-10	μA

ON CHARACTERISTICS (Note 2)

V _{GS(TH)}	Gate Threshold Voltage	V _{DS} = V _{GS} , I _D = 250 μA	0.4		1.5	V
R _{DS(ON)}	Static Drain-Source On-Resistance	V _{GS} = 4.5 V, I _D = 11 A V _{GS} = 2.5 V, I _D = 9.3 A			0.009 0.013	Ω
I _{D(ON)}	On-State Drain Current	V _{GS} = 4.5 V, V _{DS} = 5 V	25			A

DRAIN-SOURCE DIODE CHARACTERISTICS AND MAXIMUM RATINGS

I _S	Maximum Continuous Drain-Source Diode Forward Current				1.5	A
V _{SD}	Drain-Source Diode Forward Voltage	V _{GS} = 0 V, I _S = 1.5 A <small>(Note 2)</small>			1.2	V

Notes:

- R_{θJA} is the sum of the junction-to-case and case-to-ambient resistance where the case thermal reference is defined as the solder mounting surface of the drain pins. R_{θJC} is guaranteed by design while R_{θCA} is determined by the user's board design.

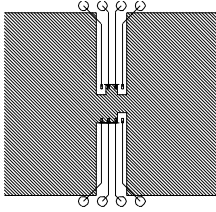

a) 70° C/W when mounted on a 1.0 in² pad of 2 oz. copper.

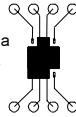

b) 125° C/W when mounted on a 0.026 in² pad of 2oz. copper.

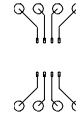

c) 135° C/W when mounted on a minimum pad.

Scale 1 : 1 on letter size paper

- Pulse Test: Pulse Width ≤ 300 μs, Duty Cycle ≤ 2.0%

SuperSOT™-8 Tape and Reel Data and Package Dimensions



SSOT-8 Packaging Configuration: Figure 1.0

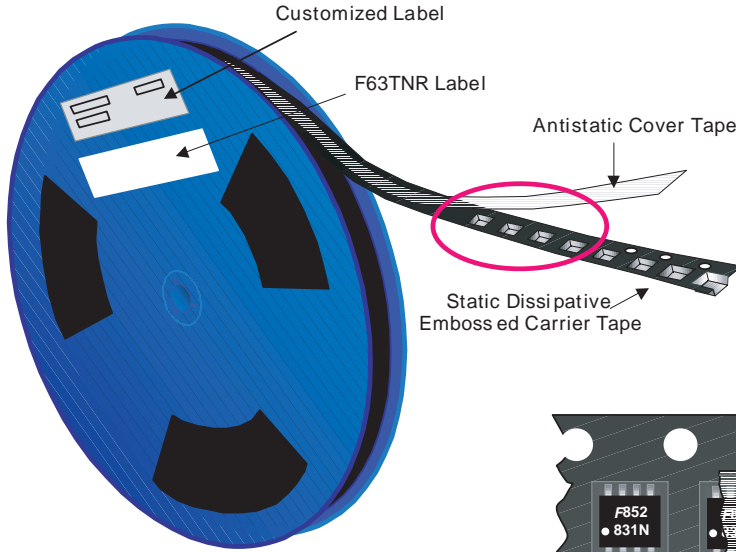

Packaging Description:

SSOT-8 parts are shipped in tape. The carrier tape is made from a dissipative (carbon filled) polycarbonate resin. The cover tape is a multilayer film (Heat Activated Adhesive in nature) primarily composed of polyester film, adhesive layer, sealant, and anti-static sprayed agent. These reeled parts in standard option are shipped with 3,000 units per 13" or 330cm diameter reel. The reels are dark blue in color and is made of polystyrene plastic (anti-static coated). Other option comes in 500 units per 7" or 177cm diameter reel. This and some other options are further described in the Packaging Information table.

These full reels are individually barcode labeled and placed inside a standard intermediate box (illustrated in figure 1.0) made of recyclable corrugated brown paper. One box contains two reels maximum. And these boxes are placed inside a barcode labeled shipping box which comes in different sizes depending on the number of parts shipped.

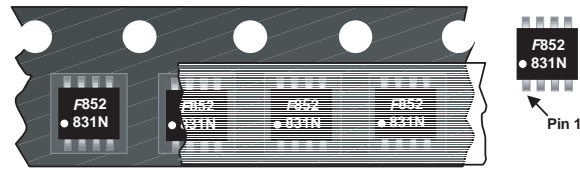

SSOT-8 Unit Orientation

SSOT-8 Packaging Information		
Packaging Option	Standard (no flow code)	D84Z
Packaging type	TNR	TNR
Qty per Reel/Tube/Bag	3,000	500
Reel Size	13" Dia	7" Dia
Box Dimension (mm)	343x64x343	184x187x47
Max qty per Box	6,000	1,000
Weight per unit (gm)	0.0416	0.0416
Weight per Reel (kg)	0.5615	0.0980
Note/Comments		

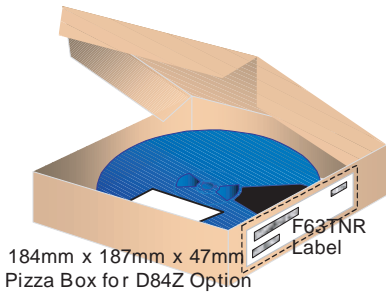
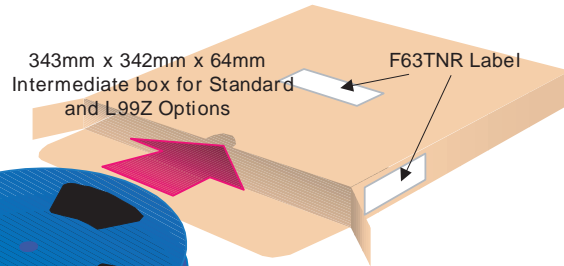

F63TNR Label sample

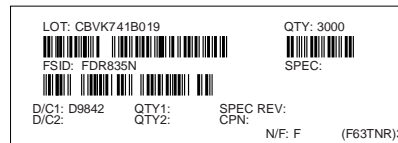

SSOT-8 Tape Leader and Trailer Configuration: Figure 2.0

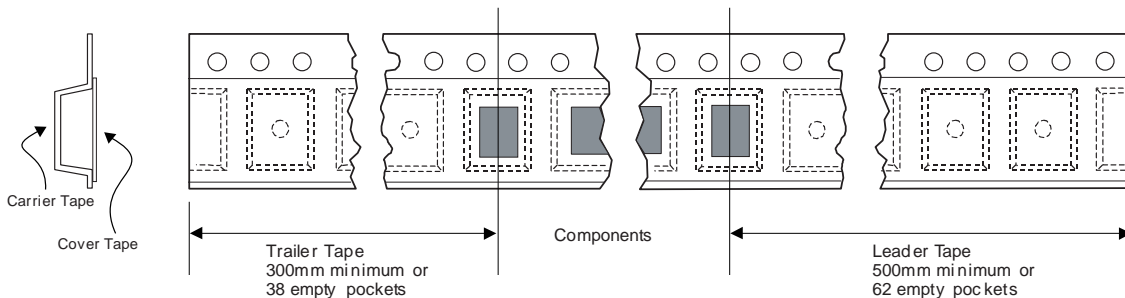

SuperSOT™-8 Tape and Reel Data and Package Dimensions, continued

SSOT-8 Embossed Carrier Tape Configuration: Figure 3.0

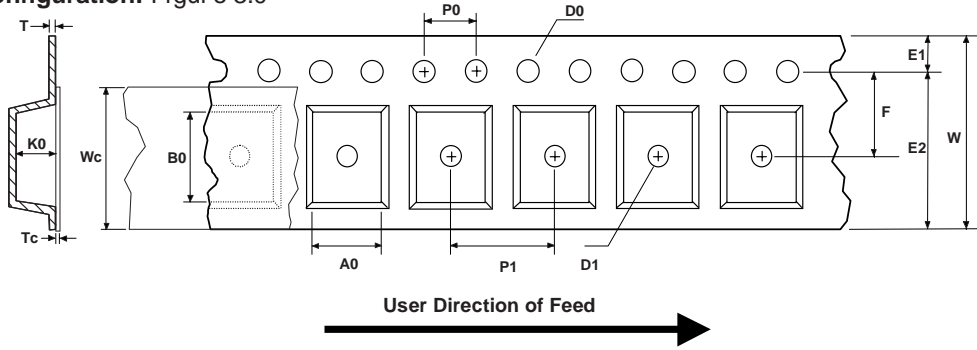

Dimensions are in millimeter

Pkg type	A0	B0	W	D0	D1	E1	E2	F	P1	P0	K0	T	Wc	Tc
SSOT-8 (12mm)	4.47 +/-0.10	5.00 +/-0.10	12.0 +/-0.3	1.55 +/-0.05	1.50 +/-0.10	1.75 +/-0.10	10.25 min	5.50 +/-0.05	8.0 +/-0.1	4.0 +/-0.1	1.37 +/-0.10	0.280 +/-0.150	9.5 +/-0.025	0.06 +/-0.02

Notes: A0, B0, and K0 dimensions are determined with respect to the EIA/Jedec RS-481 rotational and lateral movement requirements (see sketches A, B, and C).

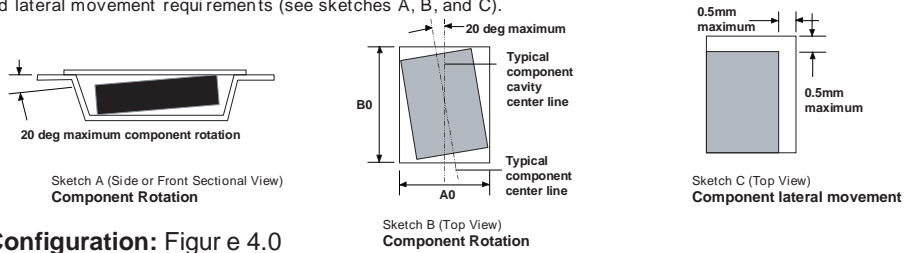

SSOT-8 Reel Configuration: Figure 4.0

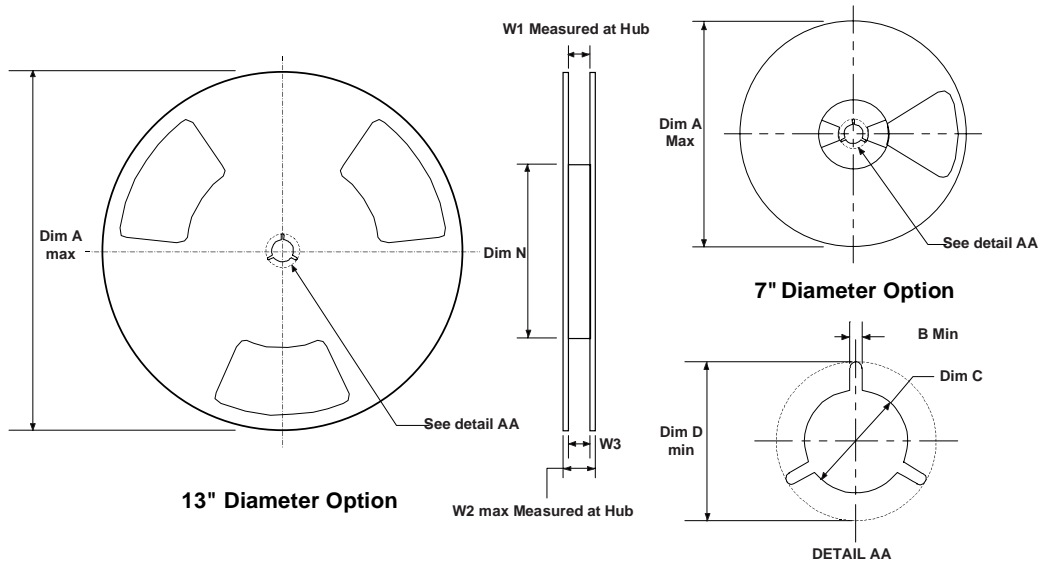

Dimensions are in inches and millimeters

Tape Size	Reel Option	Dim A	Dim B	Dim C	Dim D	Dim N	Dim W1	Dim W2	Dim W3 (LSL-USL)
12mm	7" Dia	7.00 177.8	0.059 1.5	512 +0.020/-0.008 13 +0.5/-0.2	0.795 20.2	5.906 150	0.488 +0.078/-0.000 12.4 +2/0	0.724 18.4	0.469 - 0.606 11.9 - 15.4
12mm	13" Dia	13.00 330	0.059 1.5	512 +0.020/-0.008 13 +0.5/-0.2	0.795 20.2	7.00 178	0.488 +0.078/-0.000 12.4 +2/0	0.724 18.4	0.469 - 0.606 11.9 - 15.4

SuperSOT™-8 Tape and Reel Data and Package Dimensions, continued

SuperSOT™-8 (FS PKG Code 34, 35)

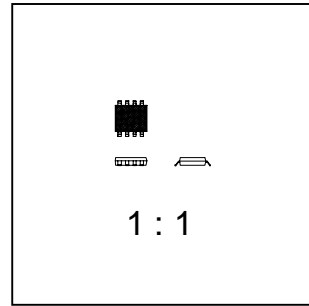
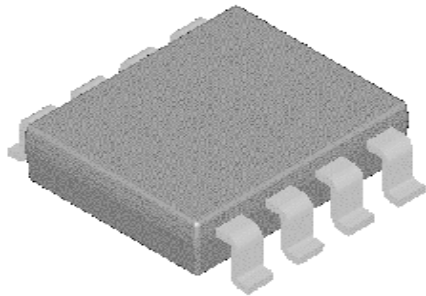

Scale 1:1 on letter size paper

Dimensions shown below are in:
inches [millimeters]

Part Weight per unit (gram): 0.0416

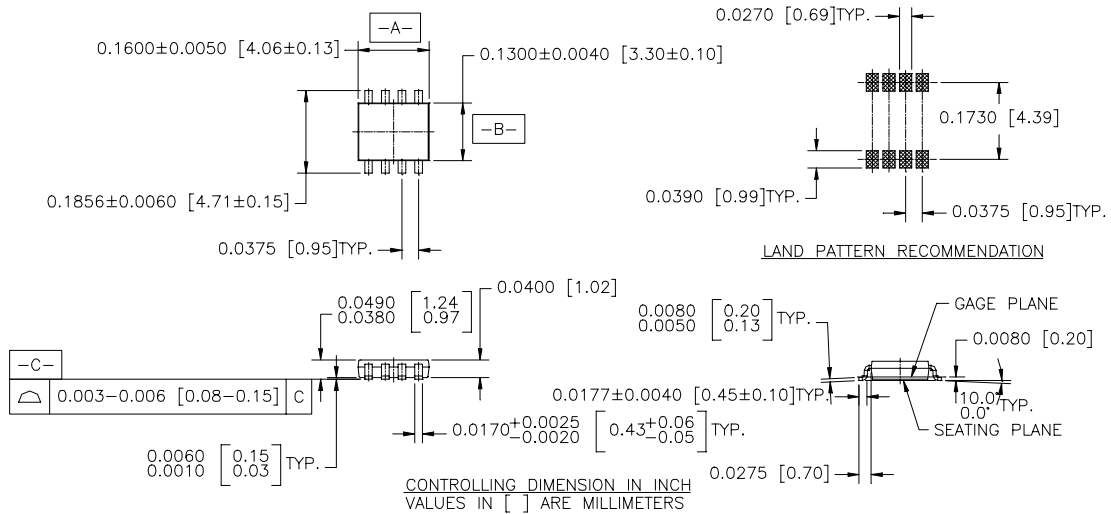

NOTES : UNLESS OTHERWISE SPECIFIED

- STANDARD LEAD FINISH TO BE 200 MICRONS / 5.08 MICROMETERS MINIMUM TIN/LEAD (SOLDER) ON COPPER.
- NO JEDEC REGISTRATION AS JAN. 1996

SUPER SOT, 8 LEADS

TRADEMARKS

The following are registered and unregistered trademarks Fairchild Semiconductor owns or is authorized to use and is not intended to be an exhaustive list of all such trademarks.

ACEx™	ISOPANAR™	TinyLogic™
CoolFET™	MICROWIRE™	UHC™
CROSSVOLT™	POP™	VCX™
E ² CMOS™	PowerTrench®	
FACT™	QFET™	
FACT Quiet Series™	QS™	
FAST®	Quiet Series™	
FASTr™	SuperSOT™-3	
GTO™	SuperSOT™-6	
HiSeC™	SuperSOT™-8	

DISCLAIMER

FAIRCHILD SEMICONDUCTOR RESERVES THE RIGHT TO MAKE CHANGES WITHOUT FURTHER NOTICE TO ANY PRODUCTS HEREIN TO IMPROVE RELIABILITY, FUNCTION OR DESIGN. FAIRCHILD DOES NOT ASSUME ANY LIABILITY ARISING OUT OF THE APPLICATION OR USE OF ANY PRODUCT OR CIRCUIT DESCRIBED HEREIN; NEITHER DOES IT CONVEY ANY LICENSE UNDER ITS PATENT RIGHTS, NOR THE RIGHTS OF OTHERS.

LIFE SUPPORT POLICY

FAIRCHILD'S PRODUCTS ARE NOT AUTHORIZED FOR USE AS CRITICAL COMPONENTS IN LIFE SUPPORT DEVICES OR SYSTEMS WITHOUT THE EXPRESS WRITTEN APPROVAL OF FAIRCHILD SEMICONDUCTOR CORPORATION. As used herein:

1. Life support devices or systems are devices or systems which, (a) are intended for surgical implant into the body, or (b) support or sustain life, or (c) whose failure to perform when properly used in accordance with instructions for use provided in the labeling, can be reasonably expected to result in significant injury to the user.
2. A critical component is any component of a life support device or system whose failure to perform can be reasonably expected to cause the failure of the life support device or system, or to affect its safety or effectiveness.

PRODUCT STATUS DEFINITIONS

Definition of Terms

Datasheet Identification	Product Status	Definition
Advance Information	Formative or In Design	This datasheet contains the design specifications for product development. Specifications may change in any manner without notice.
Preliminary	First Production	This datasheet contains preliminary data, and supplementary data will be published at a later date. Fairchild Semiconductor reserves the right to make changes at any time without notice in order to improve design.
No Identification Needed	Full Production	This datasheet contains final specifications. Fairchild Semiconductor reserves the right to make changes at any time without notice in order to improve design.
Obsolete	Not In Production	This datasheet contains specifications on a product that has been discontinued by Fairchild semiconductor. The datasheet is printed for reference information only.