

Extrusion

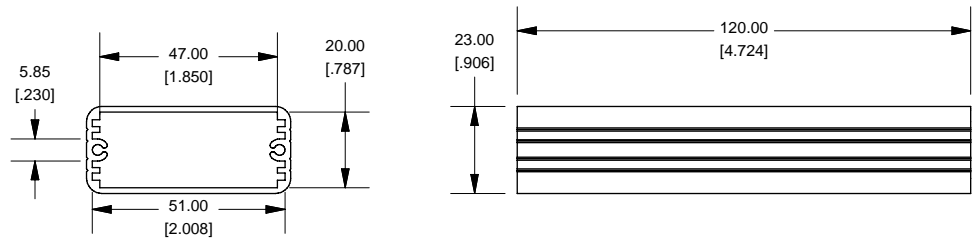

EXTRUSION DESIGNED FOR 50MM WIDE PC BOARD

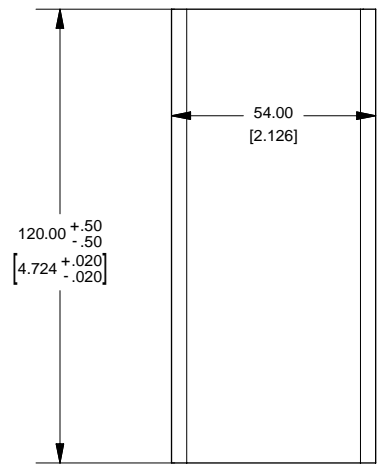
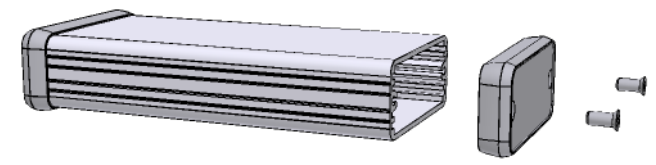

Closed Bezel

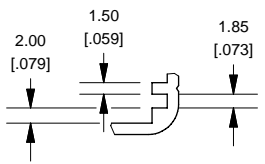
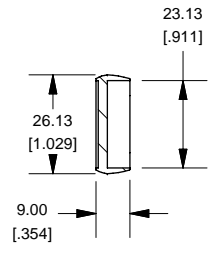
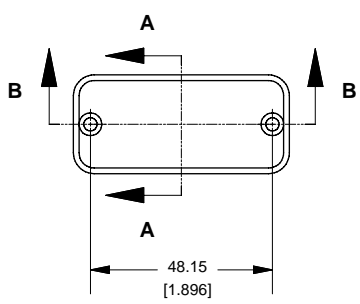

Slot Details

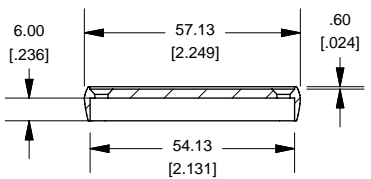

NOTE
 Purchased assembly includes box, plastic bezels, #6 Taptight screws and self adhesive rubber feet.
 Box made from Extruded Aluminum 6063.
 Bezels made with ABS

1455C1202	
PART NUMBERS	
Clear Anodized	1455C1202
Black Anodized	1455C1202BK
ACCESSORIES	
See website for accessories.	

HAMMOND MANUFACTURING™
1455C1202
 www.hammondmfg.com

Enclosures can be Factory Modified (Milling, Drilling, Printing etc.)
 Solid models of this enclosure available in STEP or IGES.
 Contact Factory mjm@hammondmfg.com