

PACKAGE DIMENSIONS

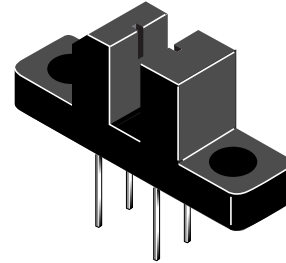

SCHEMATIC

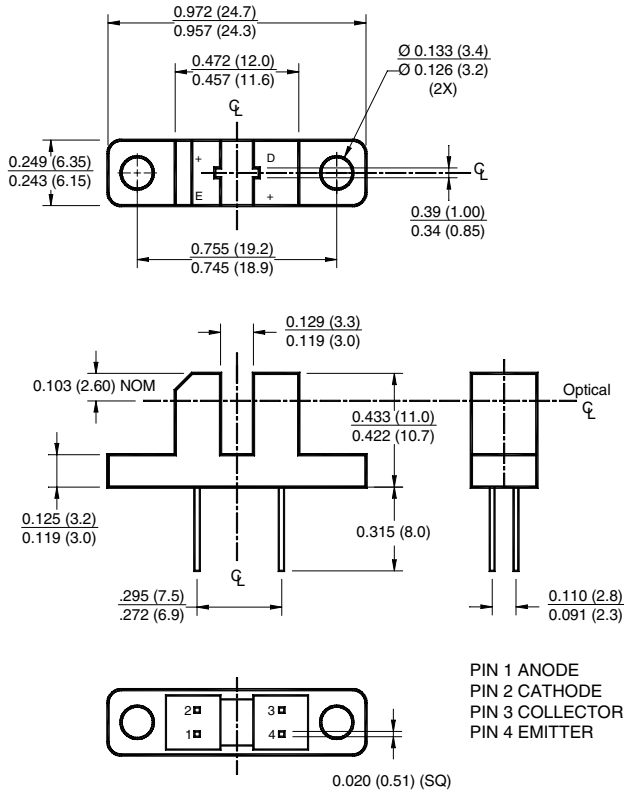
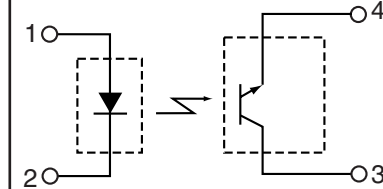

NOTES:

- Dimensions for all drawings are in inches (mm).
- Tolerance of $\pm .010$ (.25) on all non-nominal dimensions unless otherwise specified.

DESCRIPTION

The CNY28 is a gallium arsenide infrared emitting diode coupled with a silicon phototransistor in a plastic housing. The gap in the housing provides a means of interrupting the signal with tape, cards, shaft encoders or other opaque material, switching the output from an "ON" to an "OFF" state.

FEATURES

- Opaque housing
- Low cost
- 0.035" apertures
- European "Pro Electron" registered

ABSOLUTE MAXIMUM RATINGS ($T_A = 25^\circ\text{C}$ unless otherwise specified)			
Parameter	Symbol	Rating	Units
Operating Temperature	T_{OPR}	-55 to +85	$^\circ\text{C}$
Storage Temperature	T_{STG}	- 55 to +85	$^\circ\text{C}$
Soldering Temperature (Iron) ^(2,3,4)	T_{SOL-I}	240 for 5 sec	$^\circ\text{C}$
Soldering Temperature (Flow) ^(2,3)	T_{SOL-F}	260 for 10 sec	$^\circ\text{C}$
INPUT (EMITTER)			
Continuous Forward Current	I_F	50	mA
Reverse Voltage	V_R	6	V
Power Dissipation ⁽¹⁾	P_D	100	mW
OUTPUT (SENSOR)			
Collector-Emitter Voltage	V_{CEO}	30	V
Emitter- Collector Voltage	V_{ECO}	4.5	V
Collector Current	I_C	20	mA
Power Dissipation ⁽¹⁾	P_D	150	mW

NOTES:

1. Derate power dissipation linearly 1.67 mW/ $^\circ\text{C}$ above 25 $^\circ\text{C}$.
2. RMA flux is recommended.
3. Methanol or isopropyl alcohols are recommended as cleaning agents.
4. Soldering iron 1/16" (1.6mm) from housing.

ELECTRICAL / OPTICAL CHARACTERISTICS ($T_A = 25^\circ\text{C}$)						
PARAMETER	TEST CONDITIONS	SYMBOL	MIN	TYP	MAX	UNITS
INPUT (EMITTER)						
Forward Voltage	$I_F = 10 \text{ mA}$	V_F	—	—	1.7	V
Reverse Leakage Current	$V_R = 2 \text{ V}$	I_R	—	—	10	μA
OUTPUT (SENSOR)						
Emitter-Collector Breakdown	$I_E = 100 \mu\text{A}, E_e = 0$	BV_{ECO}	5.0	—	—	V
Collector-Emitter Breakdown	$I_C = 10 \text{ mA}, E_e = 0$	BV_{CEO}	30	—	—	V
Collector-Emitter Leakage	$V_{CE} = 10 \text{ V}, E_e = 0$	I_{CEO}	—	—	100	nA
COUPLED						
Collector Current	$I_F = 20 \text{ mA}, V_{CE} = 10 \text{ V}$	$I_{C(ON)}$	0.20	—	—	mA
Collector Emitter Saturation Voltage	$I_F = 20 \text{ mA}, I_C = 25 \mu\text{A}$	$V_{CE(SAT)}$	—	—	0.40	V
Turn-On Time	$I_F = 30 \text{ mA}, V_{CC} = 5 \text{ V}, R_L = 2.5 \text{ k}\Omega$	t_{on}	—	5	—	μs
Turn-Off Time	$I_F = 30 \text{ mA}, V_{CC} = 5 \text{ V}, R_L = 2.5 \text{ k}\Omega$	t_{off}	—	5	—	μs

TYPICAL PERFORMANCE CURVES

Fig. 1 Output Current vs. Input Current

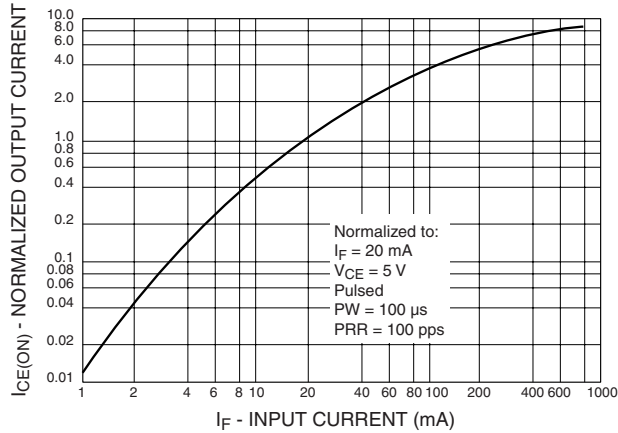

Fig. 2 Output Current vs. Temperature

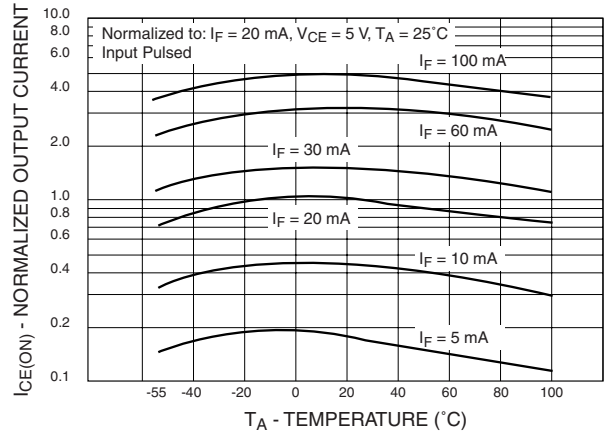

Fig. 3 Saturation Voltage vs. Ambient Temperature

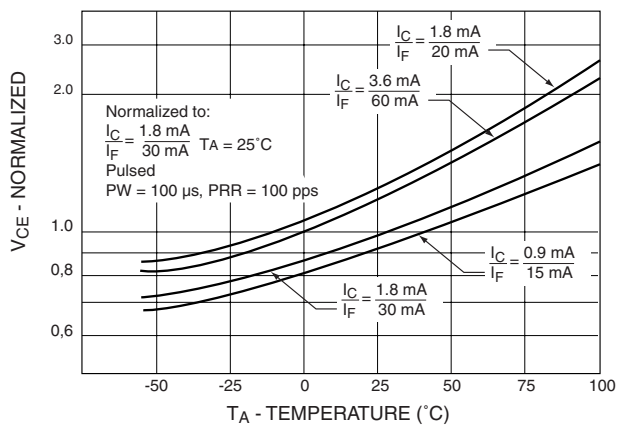

Fig. 4 Normalized Dark Current vs. Ambient Temperature (Detector)

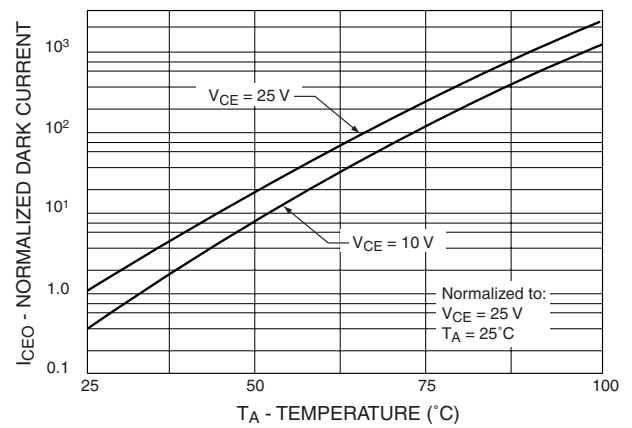
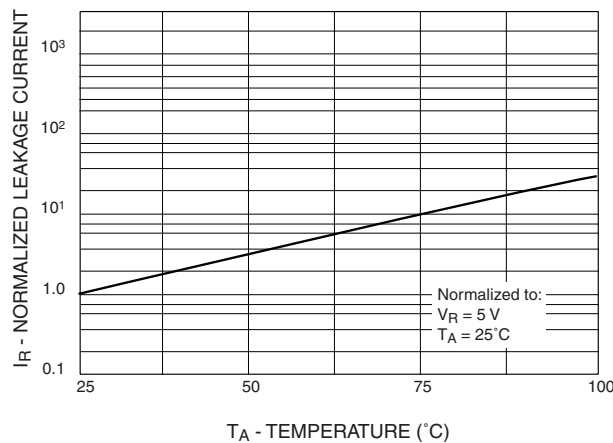

Fig. 5 Normalized Leakage Current vs. Ambient Temperature (Emitter)



TYPICAL PERFORMANCE CURVES

Fig. 6 Switching Time vs. Load Resistance

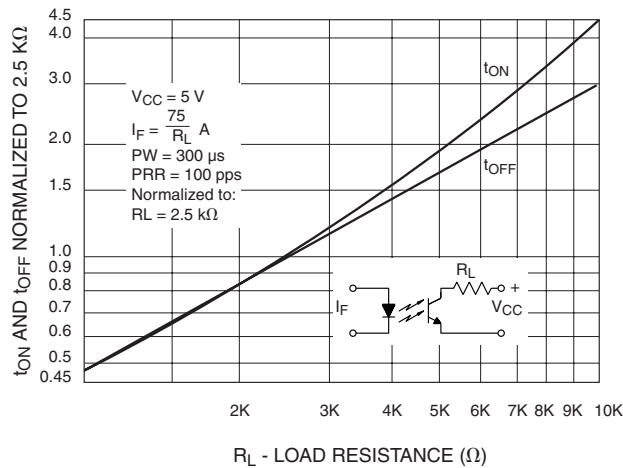
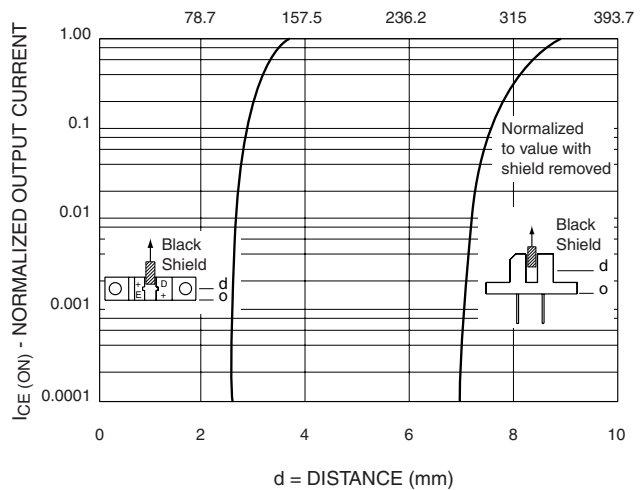

Fig. 7 Output Current vs. Distance



DISCLAIMER

FAIRCHILD SEMICONDUCTOR RESERVES THE RIGHT TO MAKE CHANGES WITHOUT FURTHER NOTICE TO ANY PRODUCTS HEREIN TO IMPROVE RELIABILITY, FUNCTION OR DESIGN. FAIRCHILD DOES NOT ASSUME ANY LIABILITY ARISING OUT OF THE APPLICATION OR USE OF ANY PRODUCT OR CIRCUIT DESCRIBED HEREIN; NEITHER DOES IT CONVEY ANY LICENSE UNDER ITS PATENT RIGHTS, NOR THE RIGHTS OF OTHERS.

LIFE SUPPORT POLICY

FAIRCHILD'S PRODUCTS ARE NOT AUTHORIZED FOR USE AS CRITICAL COMPONENTS IN LIFE SUPPORT DEVICES OR SYSTEMS WITHOUT THE EXPRESS WRITTEN APPROVAL OF THE PRESIDENT OF FAIRCHILD SEMICONDUCTOR CORPORATION. As used herein:

1. Life support devices or systems are devices or systems which, (a) are intended for surgical implant into the body, or (b) support or sustain life, and (c) whose failure to perform when properly used in accordance with instructions for use provided in labeling, can be reasonably expected to result in a significant injury of the user.
2. A critical component in any component of a life support device or system whose failure to perform can be reasonably expected to cause the failure of the life support device or system, or to affect its safety or effectiveness.