



ARM Cortex™-M0

32-BIT MICROCONTROLLER

Nu-LB-M051 User Manual
For NuMicro™ M051 Series

The information described in this document is the exclusive intellectual property of Nuvoton Technology Corporation and shall not be reproduced without permission from Nuvoton.

Nuvoton is providing this document only for reference purposes of NuMicro™ microcontroller based system design. Nuvoton assumes no responsibility for errors or omissions.

All data and specifications are subject to change without notice.

For additional information or questions, please contact: Nuvoton Technology Corporation.



1	Overview	3
2	Nu-LB-M051 Introduction	3
2.1	Functional Block of Nu -LB-M051	4
2.2	Pin Assignment for Extended Connector.....	5
3	How to Start Nu-LB-M051 on the Keil μ Vision [®] IDE.....	6
3.1	Keil uVision [®] IDE Software Download and Install	6
3.2	Nuvoton Nu-Link Driver Download and Install.....	6
3.3	Hardware Setup	6
3.4	Smpl_StartKit Example Program	7
4	How to Start Nu-LB-M051 on the IAR Embedded Workbench.....	8
4.1	IAR Embedded Workbench Software Download and Install	8
4.2	Nuvoton Nu-Link Driver Download and Install.....	8
4.3	Hardware Setup.....	8
4.4	Smpl_StartKit Example Program	9
5	Nu-LB-M051 Schematic.....	10
6	Download NuMicro [™] Family Related Files from Nuvoton Company	13
6.1	Download NuMicro [™] Keil μ Vision [®] IDE driver	13
6.2	Download NuMicro [™] IAR EWARM driver	14
6.3	Download NuMicro [™] M051 series BSP Software Library	15
7	Revision History.....	16

1 Overview

Nu-LB-M051 is the specific development tool for NuMicro M051 series. Users can use Nu-LB-M051 to learn easily how to display information, store data, communicate with PC and interact with human through M051 series. Besides, it also integrates ICE controller called Nu-Link-Me and users do not need other additional ICE or debug equipments.

2 Nu-LB-M051 Introduction

Nu-LB-M051 uses the M0516LAN as the target microcontroller and includes rich functional blocks on board. Figure 2-1 is the positive and negative Nu-LB-M051. The positive Nu-LB-M051 includes main chip (M0516LAN), INT key, reset key, variable resistance, RGB LED, 8 LEDs, 128x64 Dot Matrix LCD and RS232 interface. The negative Nu-LB-M051 includes EEPROM, Flash and ICE controller called Nu-Link-Me.

Nu-LB-M051 is similar to other development boards. Users can use the functional blocks connected with M0516LAN to develop and verify applications to emulate the real behavior. The on board chip covers M051 series features. The Nu-LB-M051 can be a real system controller to design users' target systems.

Nu-Link-Me is a Debug Adaptor. **The Nu-Link-Me Debug Adaptor connects your PC's USB port to your target system (via Serial Wired Debug Port) and allows you to program and debug embedded programs on the target hardware.** To use Nu-Link-Me Debug adaptor with IAR or Keil, please refer to "Nuvoton NuMicro™ IAR ICE driver user manual" or "Nuvoton NuMicro™ Keil ICE driver user manual" in detail. These two documents will be stored in the local hard disk when the user installs each driver.

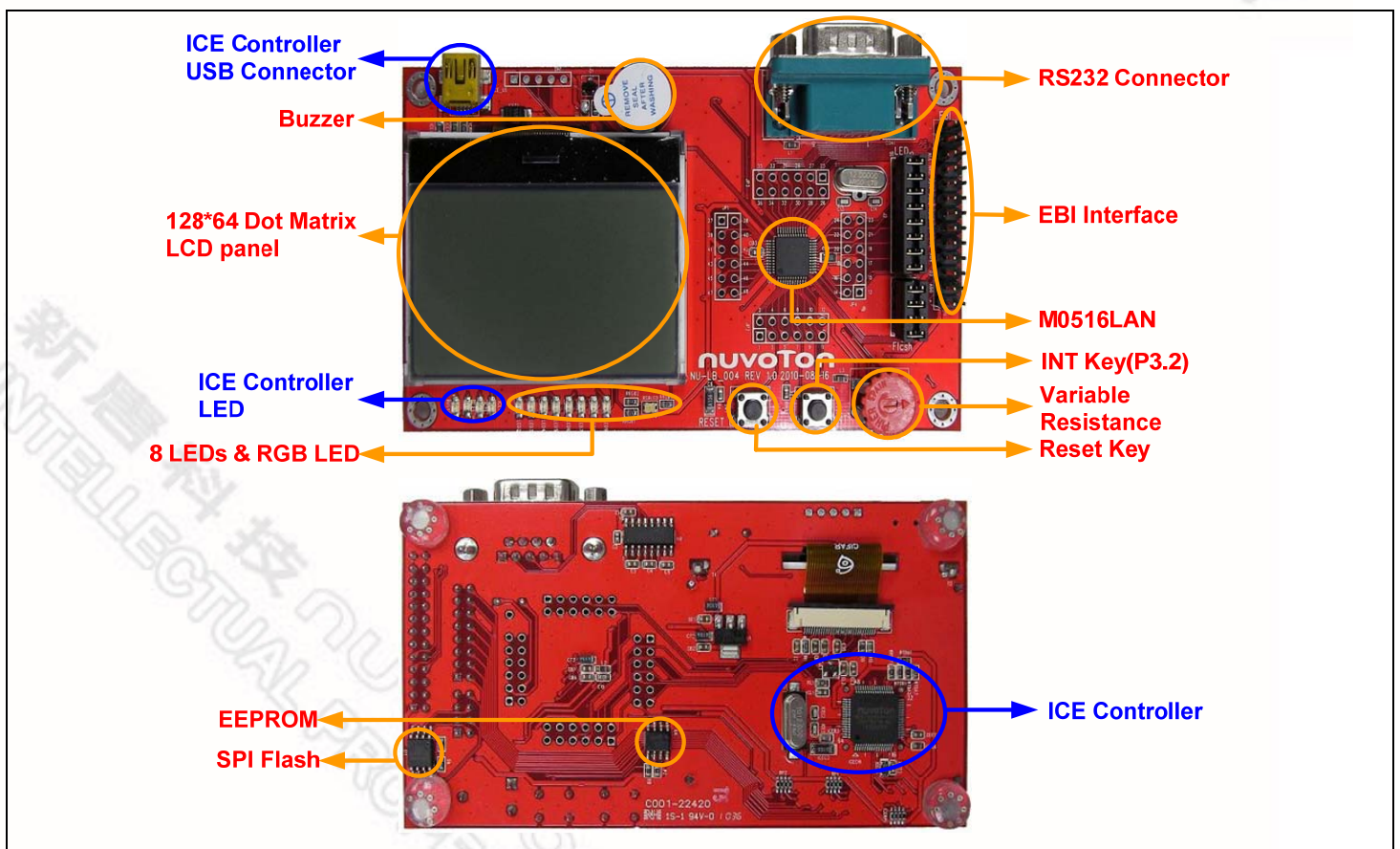

Figure 2-1 Nu-LB-M051

2.1 Functional Block of Nu -LB-M051

Nu-LB-M051 provides the rich functional blocks connected with M0516LAN to display information, communicate with PC, store data and interact with human. Users can follow the pin assignment at Table 2-1 to control every functional block.

Functional Block	Pin assignment	Pin Function Description
ICE controller(Nu-Link-Me)	ICE_CLK ICE_DATA	SWD interface
Reset Key	/RST	Reset
INT Key	P3.2	INT0
Variable Resistance	P1.0	AIN0(ADC input)
Buzzer	P4.3	PWM3
GRB LED	P4.0 P4.1 P4.2	PWM0 PWM1 PWM2
8 LEDs	P2.0~P2.7	GPIO or PWM0~PWM7
EEPROM	P3.4 P3.5	I2C SDA I2C SCL
FLASH	P0.4 P0.7 P0.6 P0.5	SPISS1 SPICLK1 MISO_1 MOSI_1
Black Dot Matrix LCD Panel	P1.4 P1.7 P1.6 P1.5 P1.1	SPISS0 SPICLK0 MISO_0(LCD Reset) MOSI_0 Background Enable/Disable
EBI Interface	P4.4 P4.5 P3.6 P3.7 P0.0~P0.7 P2.0~P2.7	/CS ALE /WR /RD AD0~AD7 AD8~AD15

Table 2-1 Functional Block for Nu-LB-M051

2.2 Pin Assignment for Extended Connector

Nu-LB-M051 provides M0516LAN on board and the extended connector for LQFP-48 pin. Table 2-2 is the pin assignment for M0516LAN.

Pin No	Pin Name	Pin No	Pin Name
01	P1.5, MOSI_0, AIN5	25	P2.5, PWM5, AD13
02	P1.6, MISO_0, AIN6	26	P2.6, PWM6, AD14
03	P1.7, SPICLK0, AIN7	27	P2.7, PWM7, AD15
04	/RST	28	P4.4, /CS
05	P3.0, RXD	29	P4.5, ALE
06	AVSS	30	P4.6, ICE_CLK
07	P3.1, TXD	31	P4.7, ICE_DAT
08	P3.2, /INT0, STADC	32	P0.7, SPISCLK1, AD7
09	P3.3, /INT1, MCLK	33	P0.6, MISO_1, AD6
10	P3.4, T0, SDA	34	P0.5, MOSI_1, AD5
11	P3.5, T1, SCL	35	P0.4, SPISS1, AD4
12	P4.3, PWM3	36	P4.1, PWM1
13	P3.6, /WR, CKO	37	P0.3, RTS0, AD3
14	P3.7, /RD	38	P0.2, CTS0, AD2
15	XTAL2	39	P0.1, RTS1, AD1
16	XTAL1	40	P0.0, CTS1, AD0
17	VSS	41	VDD
18	LDO_CAP	42	AVDD
19	P2.0, PWM0, AD8	43	P1.0, T2, AIN0
20	P2.1, PWM1, AD9	44	P1.1, T3, AIN1
21	P2.2, PWM2, AD10	45	P1.2, RXD1, AIN2
22	P2.3, PWM3, AD11	46	P1.3, TXD1, AIN3
23	P2.4, PWM4, AD12	47	P1.4, SPISS0, AIN4
24	P4.0, PWM0	48	P4.2, PWM2

Table 2-2 Pin Assignment for M0516LAN

3 How to Start Nu-LB-M051 on the Keil μ Vision[®] IDE

3.1 Keil μ Vision[®] IDE Software Download and Install

Please visit the Keil company website (<http://www.keil.com>) to download the Keil μ Vision[®] IDE and install the RVMDK.

3.2 Nuvoton Nu-Link Driver Download and Install

Please visit the Nuvoton company NuMicro[™] website (<http://www.nuvoton.com/NuMicro>) to download “NuMicro[™] Keil μ Vision[®] IDE driver” file. Please refer to Chapter 6.1 for the detail download flow. When the Nu-Link driver has been well downloaded, please unzip the file and execute the “Nu-Link_Keil_Driver.exe” to install the driver.

3.3 Hardware Setup

The hardware setup is shown as Figure 3-1



Figure 3-1 Nu-LB-M051 Hardware Setup

3.4 Smpl_StartKit Example Program

This example demonstrates the ease of downloading and debugging an application on a Nu-LB-M051 board. It can be found on Figure 3-2 list directory and downloaded from Nuvoton NuMicro™ website following on Chapter 6.3.

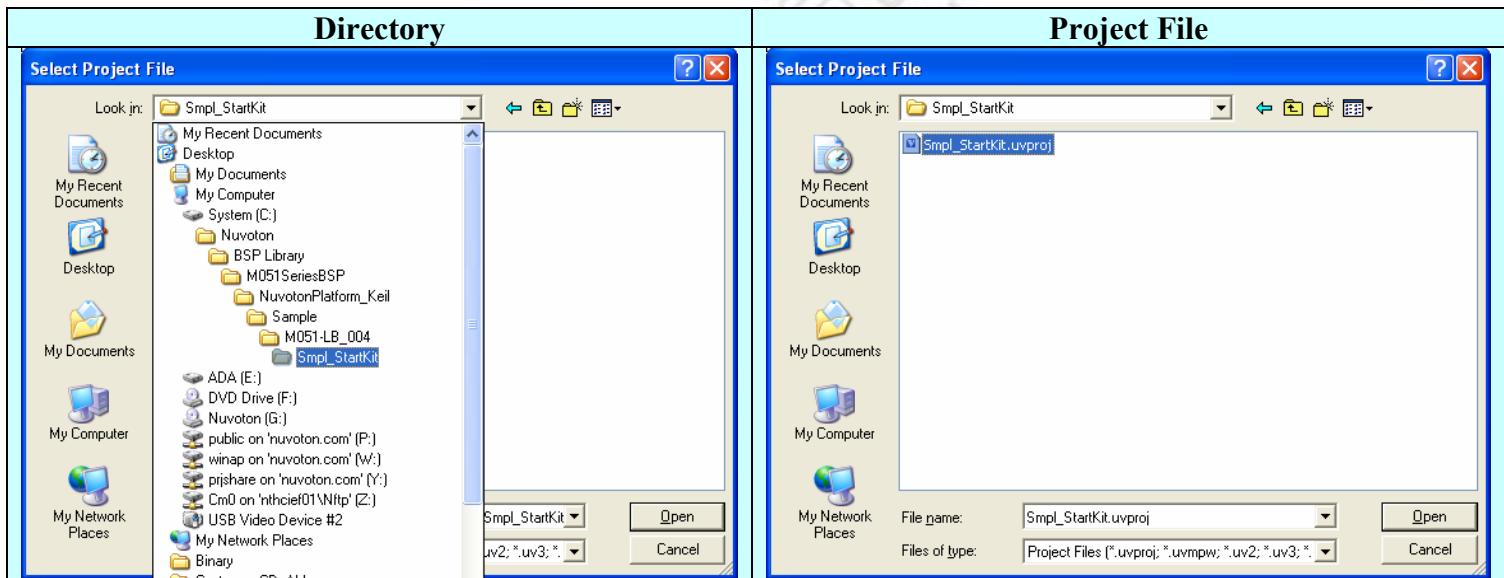









Figure 3-2 Smpl_StartKit Example Directory

To use this example:

The LCD will display the result of ADC on the Nu-LB-M051 board.

-  **Start μVision®**
- **Project-Open**
Open the Smpl_StartKit.uvproj project file
-  **Project - Build**
Compile and link the Smpl_StartKit application
-  **Flash – Download**
Program the application code into on-chip Flash ROM
-  **Start debug mode**
Using the debugger commands, you may:
 - ◆  Review variables in the watch window
 - ◆  Single step through code
 - ◆  RST Reset the device
 - ◆  Run the application

4 How to Start Nu-LB-M051 on the IAR Embedded Workbench

4.1 IAR Embedded Workbench Software Download and Install

Please connect to IAR company website (<http://www.iar.com>) to download the IAR Embedded Workbench and install the EWARM.

4.2 Nuvoton Nu-Link Driver Download and Install

Please connect to the Nuvoton Company NuMicro™ website (<http://www.nuvoton.com/NuMicro>) to download “NuMicro™ IAR ICE driver user manual” file. Please refer to Chapter 6.2 for the detail download flow. When the Nu-Link driver has been well downloaded, please unzip the file and execute the “Nu-Link_IAR_Driver.exe” to install the driver.

4.3 Hardware Setup

The hardware setup is shown as Figure 4-1



Figure 4-1 Nu-LB-M051 Hardware Setup

4.4 Smpl_StartKit Example Program

This example demonstrates the ease of downloading and debugging an application on a Nu-LB-M051 board. It can be found on Figure 4-2 list directory and downloaded from Nuvoton NuMicro™ website following on Chapter 6.3.

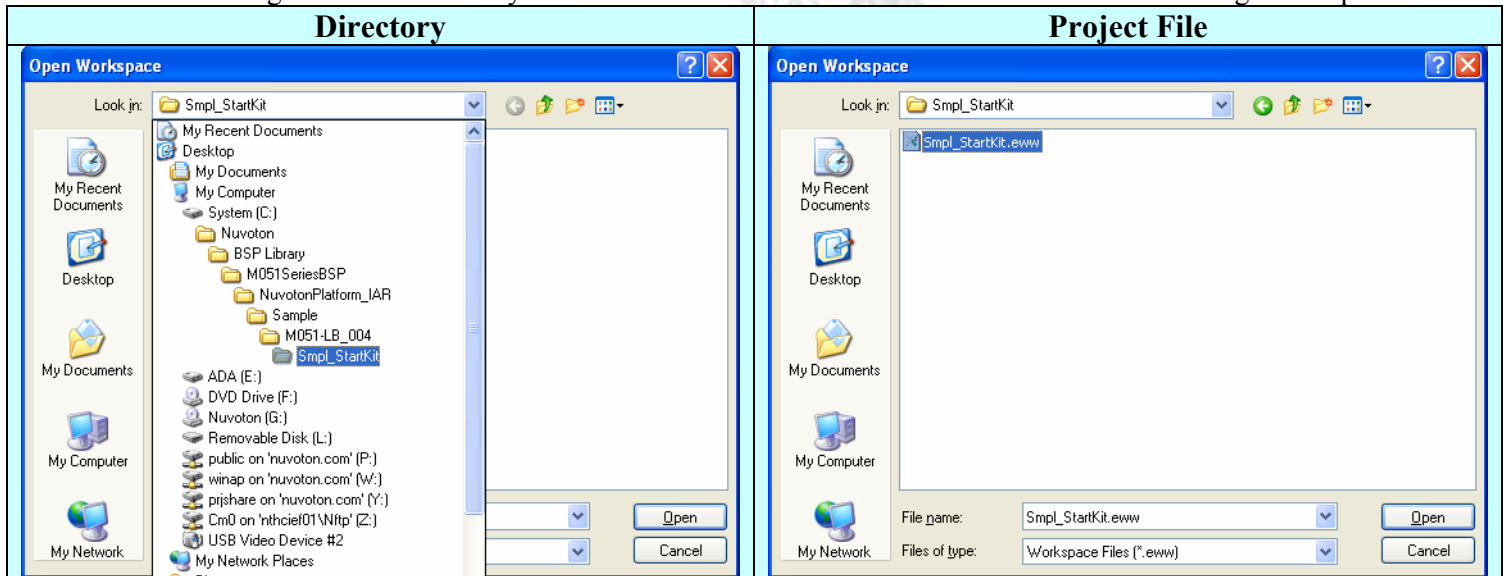







Figure 4-2 Smpl_StartKit Example Directory

To use this example:

The LCD will display the result of ADC on the Nu-LB-M051 board.

-  **Start IAR Embedded Workbench**
- **File-Open-Workspace**
Open the Smpl_StartKit.eww workspace file
-  **Project - Make**
Compile and link the Smpl_StartKit application
-  **Project – Download and Debug**
Program the application code into on-chip Flash ROM.
 - ◆  Single step through code
 - ◆  Reset the device
 - ◆  Run the application

5 Nu-LB-M051 Schematic

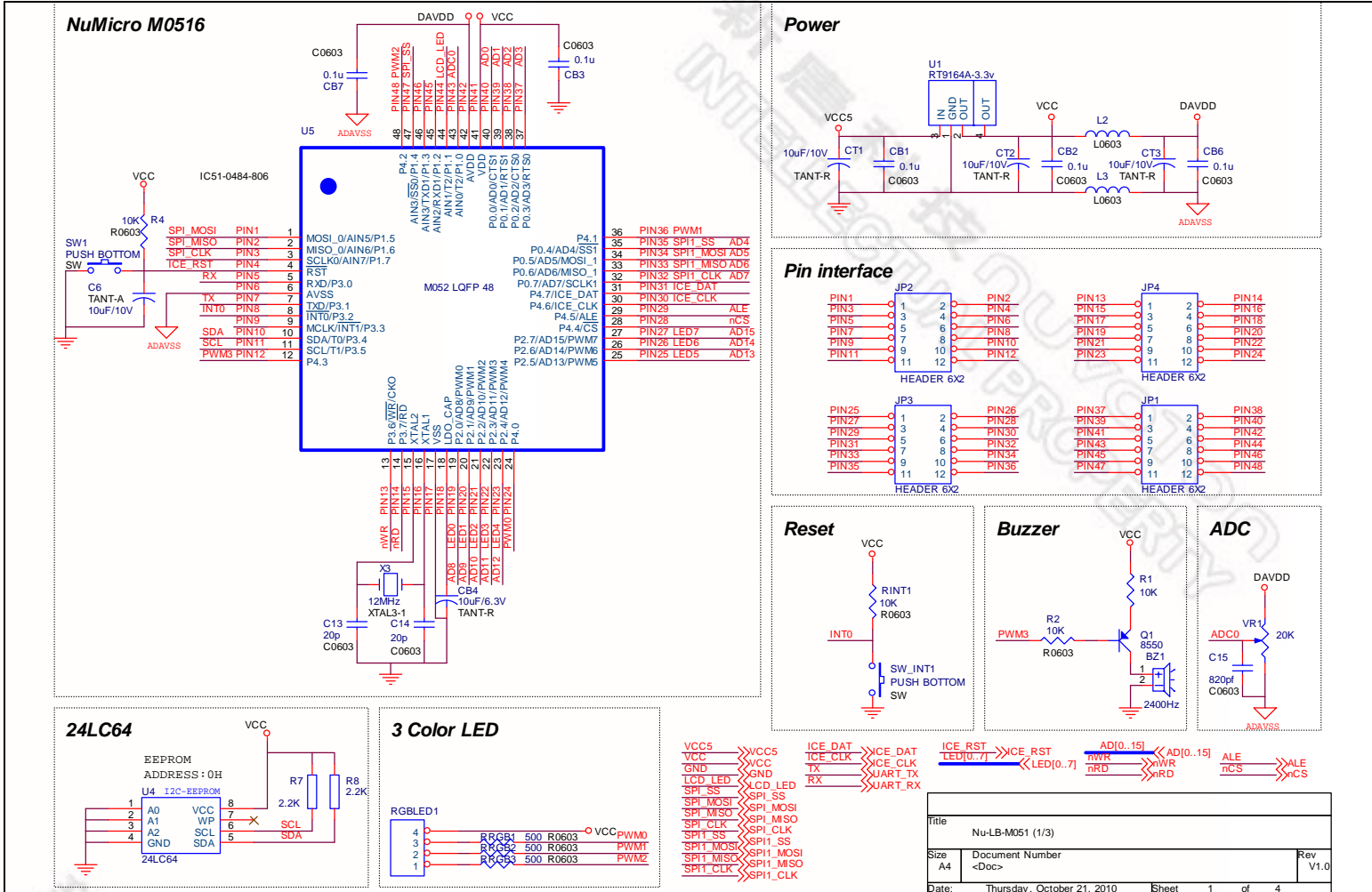

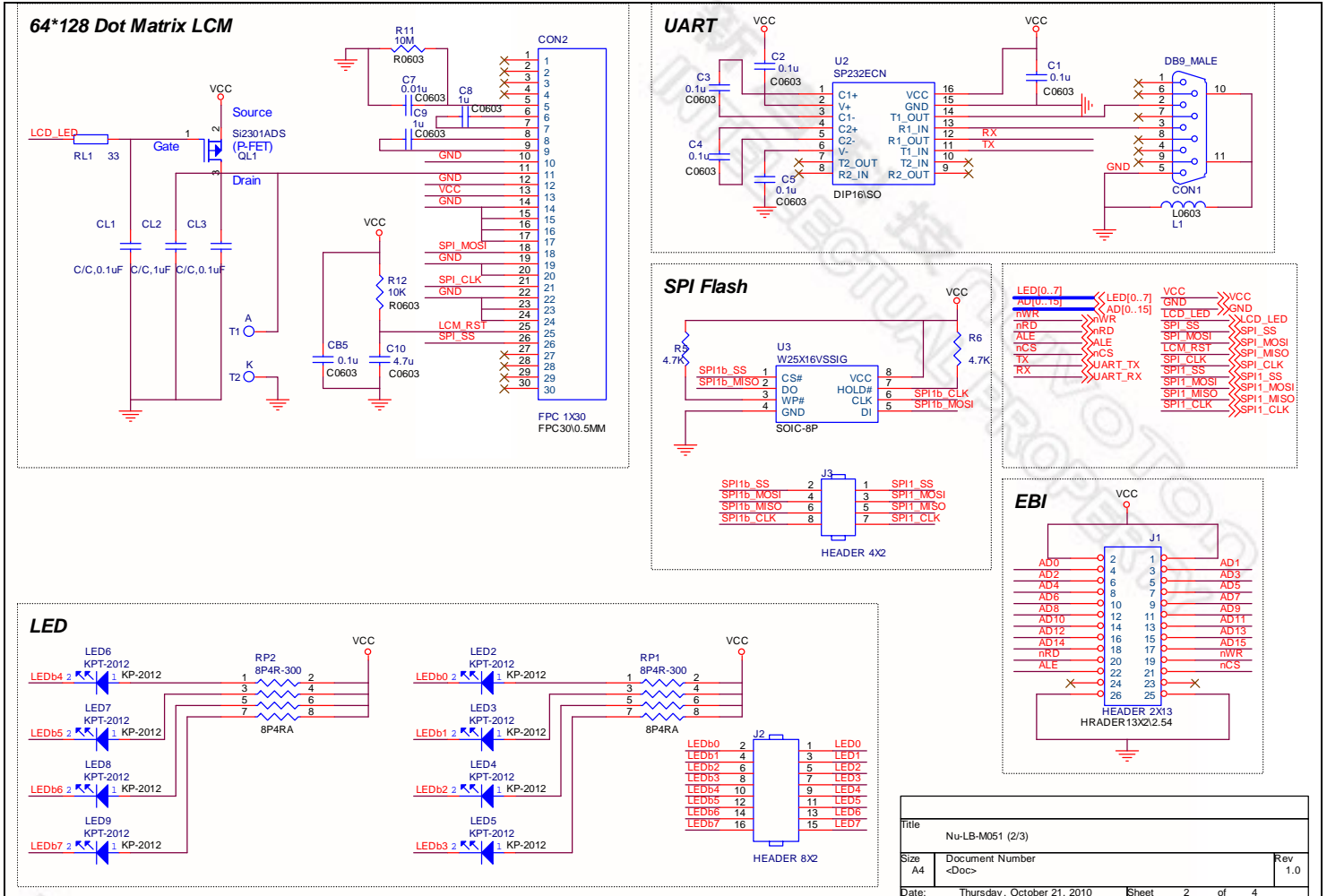

Title			
Nu-LB-M051 (2/3)			
Size	A4	Document Number	<Doc>
Date:	Thursday, October 21, 2010	Sheet	2 of 4
		Rev	1.0

新唐科技 NUVOTON
INTELLECTUAL PROPERTY

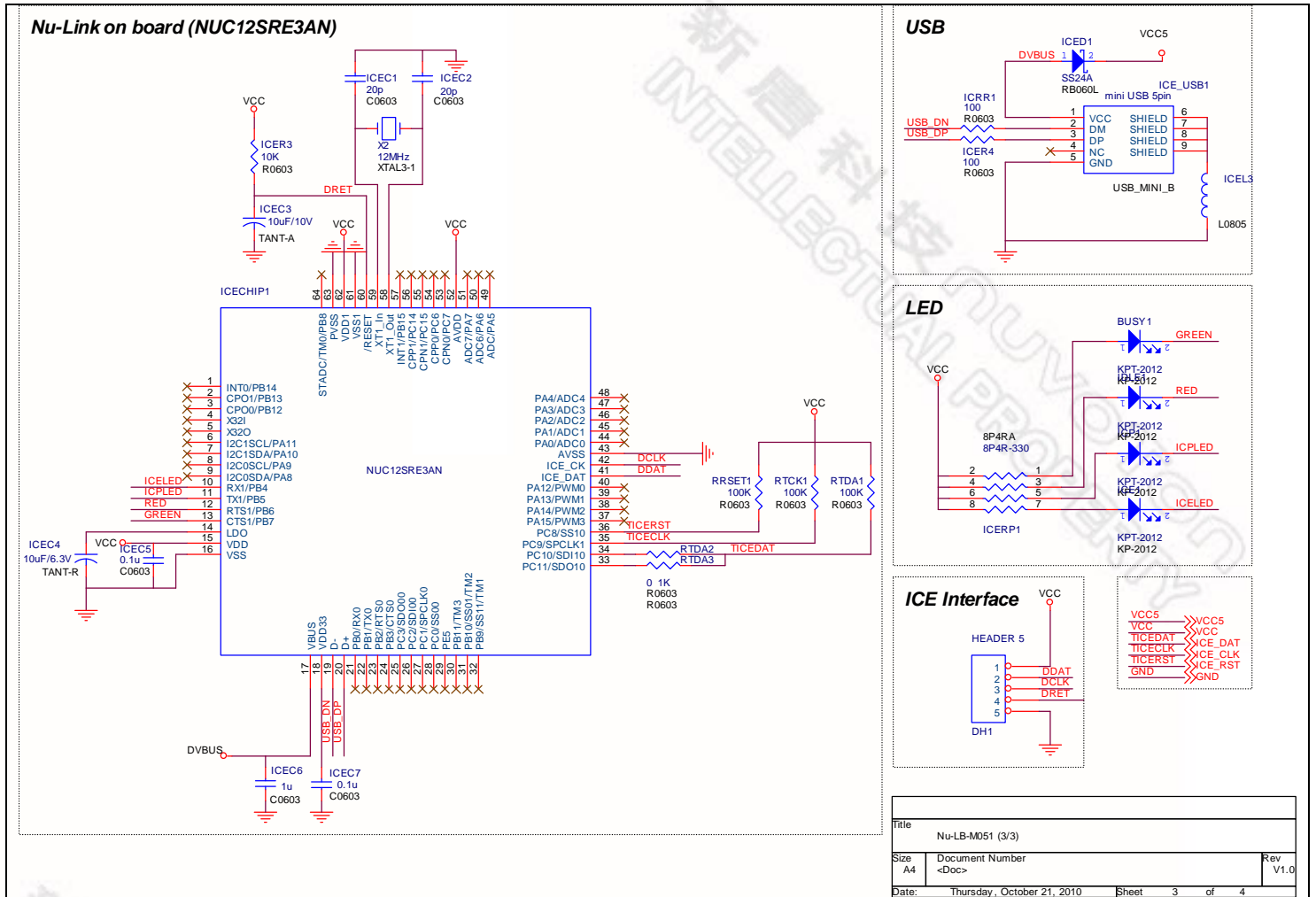

6 Download NuMicro™ Family Related Files from Nuvoton Company

6.1 Download NuMicro™ Keil μVision® IDE driver

<p>Step1</p>	<p>Visit the Nuvoton NuMicro™ website: http://www.nuvoton.com/NuMicro</p>																																							
<p>Step2</p>																																								
<p>Step 3</p>	<table border="1" data-bbox="446 1119 1274 1402"> <tr> <td>Nu-LB</td> <td> <ul style="list-style-type: none"> Nu-LB </td> <td> NUC100 NUC120 NUC130 NUC140 </td> <td> <ul style="list-style-type: none"> A Starter Kit made by Nuvoton Keil MDK-ARM (evaluation version) included Examples with source code included </td> <td></td> <td>Check Disty!</td> </tr> <tr> <td>Nu-IAR-SKT</td> <td> <ul style="list-style-type: none"> EVB w/M-Link USB Cable Setup CD </td> <td> NUC100 NUC120 NUC130 NUC140 </td> <td> <ul style="list-style-type: none"> Starter Kit made by IAR IAR EWARM (evaluation version) Included IAR C/C++ Compiler included USB Plug & Play </td> <td></td> <td>Buy Online!</td> </tr> <tr> <td>Nu-Keil-SKT</td> <td> <ul style="list-style-type: none"> U-LINK-ME MCBNUC1XX USB Cable Setup CD </td> <td> NUC100 NUC120 NUC130 NUC140 </td> <td> <ul style="list-style-type: none"> Starter Kit made by Keil Keil MDK-ARM (evaluation version) included ARM C/C++ Compiler included USB Plug & Play </td> <td></td> <td>Check Disty!</td> </tr> </table> <table border="1" data-bbox="446 1423 1274 1785"> <thead> <tr> <th>File name</th> <th>Description</th> <th>Version</th> </tr> </thead> <tbody> <tr> <td> NUC1xx Quick Start Guide for Keil uVision4 V1.00.zip</td> <td>Quick start guide using Keil™ RVMDK</td> <td>V1.00</td> </tr> <tr> <td> NuMicro Keil uVision® IDE driver (Build 4033) V1.02.zip</td> <td>The Nuvoton NuMicro Keil uVision® Driver allows the Keil uVision® IDE to communicate with Nuvoton Nu-Link ICE bridge.</td> <td>V1.02</td> </tr> <tr> <td> NuMicro IAR Embedded Workbench® driver (Build 4033) V1.02.zip</td> <td>The Nuvoton NuMicro IAR Embedded Workbench® drive allows the IAR Embedded Workbench IDE above v5.41 to communicate with Nuvoton Nu-Link ICE bridge.</td> <td>V1.02</td> </tr> <tr> <td> NuMicro ICP (Build 4033) V1.02.zip</td> <td>NuMicro ICP tool & user manual</td> <td>V1.02</td> </tr> <tr> <td> NUC1xx ISP V1.08.zip</td> <td>NUC1xx ISP tool & user manual</td> <td>V1.08</td> </tr> <tr> <td> NIIC1xx Nu-EVB_001 Board Schematic v2.0.pdf</td> <td>NUC1xx Nu-EVB_001 Board Schematic</td> <td>V2.0</td> </tr> </tbody> </table> <p>A yellow callout bubble points to the 'NuMicro Keil uVision® IDE driver (Build 4033) V1.02.zip' file in the table above.</p>	Nu-LB	<ul style="list-style-type: none"> Nu-LB 	NUC100 NUC120 NUC130 NUC140	<ul style="list-style-type: none"> A Starter Kit made by Nuvoton Keil MDK-ARM (evaluation version) included Examples with source code included 		Check Disty!	Nu-IAR-SKT	<ul style="list-style-type: none"> EVB w/M-Link USB Cable Setup CD 	NUC100 NUC120 NUC130 NUC140	<ul style="list-style-type: none"> Starter Kit made by IAR IAR EWARM (evaluation version) Included IAR C/C++ Compiler included USB Plug & Play 		Buy Online!	Nu-Keil-SKT	<ul style="list-style-type: none"> U-LINK-ME MCBNUC1XX USB Cable Setup CD 	NUC100 NUC120 NUC130 NUC140	<ul style="list-style-type: none"> Starter Kit made by Keil Keil MDK-ARM (evaluation version) included ARM C/C++ Compiler included USB Plug & Play 		Check Disty!	File name	Description	Version	NUC1xx Quick Start Guide for Keil uVision4 V1.00.zip	Quick start guide using Keil™ RVMDK	V1.00	NuMicro Keil uVision® IDE driver (Build 4033) V1.02.zip	The Nuvoton NuMicro Keil uVision® Driver allows the Keil uVision® IDE to communicate with Nuvoton Nu-Link ICE bridge.	V1.02	NuMicro IAR Embedded Workbench® driver (Build 4033) V1.02.zip	The Nuvoton NuMicro IAR Embedded Workbench® drive allows the IAR Embedded Workbench IDE above v5.41 to communicate with Nuvoton Nu-Link ICE bridge.	V1.02	NuMicro ICP (Build 4033) V1.02.zip	NuMicro ICP tool & user manual	V1.02	NUC1xx ISP V1.08.zip	NUC1xx ISP tool & user manual	V1.08	NIIC1xx Nu-EVB_001 Board Schematic v2.0.pdf	NUC1xx Nu-EVB_001 Board Schematic	V2.0
Nu-LB	<ul style="list-style-type: none"> Nu-LB 	NUC100 NUC120 NUC130 NUC140	<ul style="list-style-type: none"> A Starter Kit made by Nuvoton Keil MDK-ARM (evaluation version) included Examples with source code included 		Check Disty!																																			
Nu-IAR-SKT	<ul style="list-style-type: none"> EVB w/M-Link USB Cable Setup CD 	NUC100 NUC120 NUC130 NUC140	<ul style="list-style-type: none"> Starter Kit made by IAR IAR EWARM (evaluation version) Included IAR C/C++ Compiler included USB Plug & Play 		Buy Online!																																			
Nu-Keil-SKT	<ul style="list-style-type: none"> U-LINK-ME MCBNUC1XX USB Cable Setup CD 	NUC100 NUC120 NUC130 NUC140	<ul style="list-style-type: none"> Starter Kit made by Keil Keil MDK-ARM (evaluation version) included ARM C/C++ Compiler included USB Plug & Play 		Check Disty!																																			
File name	Description	Version																																						
NUC1xx Quick Start Guide for Keil uVision4 V1.00.zip	Quick start guide using Keil™ RVMDK	V1.00																																						
NuMicro Keil uVision® IDE driver (Build 4033) V1.02.zip	The Nuvoton NuMicro Keil uVision® Driver allows the Keil uVision® IDE to communicate with Nuvoton Nu-Link ICE bridge.	V1.02																																						
NuMicro IAR Embedded Workbench® driver (Build 4033) V1.02.zip	The Nuvoton NuMicro IAR Embedded Workbench® drive allows the IAR Embedded Workbench IDE above v5.41 to communicate with Nuvoton Nu-Link ICE bridge.	V1.02																																						
NuMicro ICP (Build 4033) V1.02.zip	NuMicro ICP tool & user manual	V1.02																																						
NUC1xx ISP V1.08.zip	NUC1xx ISP tool & user manual	V1.08																																						
NIIC1xx Nu-EVB_001 Board Schematic v2.0.pdf	NUC1xx Nu-EVB_001 Board Schematic	V2.0																																						
<p>Step 4</p>	<p>Download the NuMicro Keil μVision® IDE driver</p>																																							

6.2 Download NuMicro™ IAR EWARM driver

<p>Step1</p>	<p>Visit the Nuvoton NuMicro™ website: http://www.nuvoton.com/NuMicro</p>																																							
<p>Step2</p>	<p>Click here to enter Development Tools page</p> <p>ARM Cortex™ M0 NuMicro® Family</p> <p>NuMicro® Family is Nuvoton's brand-new 32-bit Microcontroller product line based on the ARM® Cortex™ M0 processor with rich peripherals to offer superb features and connectivity including the NUC100, NUC120, NUC130 and NUC140 series, a new series the NuMicro M051™ series, including the M051A450/515 to to satisfy the worldwide customers' 8-bit/16-bit microcontroller demand with a higher performance of a 32-bit microcontroller.</p> <p>Technical Library</p> <ul style="list-style-type: none"> On-Line Products Selection Guide Datasheet & Technical Reference Manual Software Library Application Notes FAQ <p>Development Tools and Study</p> <ul style="list-style-type: none"> Development Tools & File Download Starter Kit On-Line Training <p>Information Notes</p> <ul style="list-style-type: none"> Events E-News M051 Series T888 M051 Series BSP by CMSIS NuMicro Keil uVision® IDE Driver <p>NuMicro® Family</p> <p>M051 Base Line</p> <ul style="list-style-type: none"> Up to 64KB Flash, 16KB SRAM Up to 4KB SRAM NuMicro M051 Cortex-M0 <p>NUC100 Advance Line</p> <p>UART</p>																																							
<p>Step 3</p>	<table border="1"> <tr> <td>Nu-LB</td> <td> <ul style="list-style-type: none"> Nu-LB </td> <td> NUC100 NUC120 NUC130 NUC140 </td> <td> <ul style="list-style-type: none"> A Starter Kit made by Nuvoton Keil MDK-ARM (evaluation version) included Examples with source code included </td> <td></td> <td>Check Disty!</td> </tr> <tr> <td>Nu-IAR-SKT</td> <td> <ul style="list-style-type: none"> EVB w/M-Link USB Cable Setup CD </td> <td> NUC100 NUC120 NUC130 NUC140 </td> <td> <ul style="list-style-type: none"> Starter Kit made by IAR IAR EWARM (evaluation version) Included IAR C/C++ Compiler included USB Plug & Play </td> <td></td> <td>Buy Online!</td> </tr> <tr> <td>Nu-Keil-SKT</td> <td> <ul style="list-style-type: none"> U-LINK-ME MCBNUC1XX USB Cable Setup CD </td> <td> NUC100 NUC120 NUC130 NUC140 </td> <td> <ul style="list-style-type: none"> Starter Kit made by Keil Keil MDK-ARM (evaluation version) included ARM C/C++ Compiler included USB Plug & Play </td> <td></td> <td>Check Disty!</td> </tr> </table> <p>File Download</p> <table border="1"> <thead> <tr> <th>File name</th> <th>Description</th> <th>Version</th> </tr> </thead> <tbody> <tr> <td>NUC1xx Quick Start Guide for Keil uVision4 V1.00.zip</td> <td>Quick start guide using Keil® RVMDK</td> <td>V1.00</td> </tr> <tr> <td>NuMicro Keil uVision® IDE driver (Build 4033) V1.02.zip</td> <td>The Nuvoton NuMicro Keil uVision® Driver allows the Keil uVision® IDE to communicate with Nuvoton Nu-Link ICE bridge.</td> <td>V1.02</td> </tr> <tr> <td>NuMicro IAR Embedded Workbench® driver (Build 4033) V1.02.zip</td> <td>The Nuvoton NuMicro IAR Embedded Workbench® driver allows the IAR Embedded Workbench IDE above v5.41 to communicate with Nuvoton Nu-Link ICE bridge.</td> <td>V1.02</td> </tr> <tr> <td>NuMicro ICP (Build 4033) V1.02.zip</td> <td>NuMicro ICP tool & user manual</td> <td>V1.02</td> </tr> <tr> <td>NUC1xx ISP V1.08.zip</td> <td>NUC1xx ISP tool & user manual</td> <td>V1.08</td> </tr> <tr> <td>NIIC1xx Nu-EVB_001 Board Schematic v2.0.pdf</td> <td>NUC1xx Nu-EVB_001 Board Schematic</td> <td>V2.0</td> </tr> </tbody> </table> <p>To download the file</p>	Nu-LB	<ul style="list-style-type: none"> Nu-LB 	NUC100 NUC120 NUC130 NUC140	<ul style="list-style-type: none"> A Starter Kit made by Nuvoton Keil MDK-ARM (evaluation version) included Examples with source code included 		Check Disty!	Nu-IAR-SKT	<ul style="list-style-type: none"> EVB w/M-Link USB Cable Setup CD 	NUC100 NUC120 NUC130 NUC140	<ul style="list-style-type: none"> Starter Kit made by IAR IAR EWARM (evaluation version) Included IAR C/C++ Compiler included USB Plug & Play 		Buy Online!	Nu-Keil-SKT	<ul style="list-style-type: none"> U-LINK-ME MCBNUC1XX USB Cable Setup CD 	NUC100 NUC120 NUC130 NUC140	<ul style="list-style-type: none"> Starter Kit made by Keil Keil MDK-ARM (evaluation version) included ARM C/C++ Compiler included USB Plug & Play 		Check Disty!	File name	Description	Version	NUC1xx Quick Start Guide for Keil uVision4 V1.00.zip	Quick start guide using Keil® RVMDK	V1.00	NuMicro Keil uVision® IDE driver (Build 4033) V1.02.zip	The Nuvoton NuMicro Keil uVision® Driver allows the Keil uVision® IDE to communicate with Nuvoton Nu-Link ICE bridge.	V1.02	NuMicro IAR Embedded Workbench® driver (Build 4033) V1.02.zip	The Nuvoton NuMicro IAR Embedded Workbench® driver allows the IAR Embedded Workbench IDE above v5.41 to communicate with Nuvoton Nu-Link ICE bridge.	V1.02	NuMicro ICP (Build 4033) V1.02.zip	NuMicro ICP tool & user manual	V1.02	NUC1xx ISP V1.08.zip	NUC1xx ISP tool & user manual	V1.08	NIIC1xx Nu-EVB_001 Board Schematic v2.0.pdf	NUC1xx Nu-EVB_001 Board Schematic	V2.0
Nu-LB	<ul style="list-style-type: none"> Nu-LB 	NUC100 NUC120 NUC130 NUC140	<ul style="list-style-type: none"> A Starter Kit made by Nuvoton Keil MDK-ARM (evaluation version) included Examples with source code included 		Check Disty!																																			
Nu-IAR-SKT	<ul style="list-style-type: none"> EVB w/M-Link USB Cable Setup CD 	NUC100 NUC120 NUC130 NUC140	<ul style="list-style-type: none"> Starter Kit made by IAR IAR EWARM (evaluation version) Included IAR C/C++ Compiler included USB Plug & Play 		Buy Online!																																			
Nu-Keil-SKT	<ul style="list-style-type: none"> U-LINK-ME MCBNUC1XX USB Cable Setup CD 	NUC100 NUC120 NUC130 NUC140	<ul style="list-style-type: none"> Starter Kit made by Keil Keil MDK-ARM (evaluation version) included ARM C/C++ Compiler included USB Plug & Play 		Check Disty!																																			
File name	Description	Version																																						
NUC1xx Quick Start Guide for Keil uVision4 V1.00.zip	Quick start guide using Keil® RVMDK	V1.00																																						
NuMicro Keil uVision® IDE driver (Build 4033) V1.02.zip	The Nuvoton NuMicro Keil uVision® Driver allows the Keil uVision® IDE to communicate with Nuvoton Nu-Link ICE bridge.	V1.02																																						
NuMicro IAR Embedded Workbench® driver (Build 4033) V1.02.zip	The Nuvoton NuMicro IAR Embedded Workbench® driver allows the IAR Embedded Workbench IDE above v5.41 to communicate with Nuvoton Nu-Link ICE bridge.	V1.02																																						
NuMicro ICP (Build 4033) V1.02.zip	NuMicro ICP tool & user manual	V1.02																																						
NUC1xx ISP V1.08.zip	NUC1xx ISP tool & user manual	V1.08																																						
NIIC1xx Nu-EVB_001 Board Schematic v2.0.pdf	NUC1xx Nu-EVB_001 Board Schematic	V2.0																																						
<p>Step 4</p>	<p>Download the NuMicro™ IAR Embedded Workbench® driver</p>																																							

6.3 Download NuMicro™ M051 series BSP Software Library

Step1	Visit the Nuvoton NuMicro™ website: http://www.nuvoton.com/NuMicro
Step2	<p>Click here to enter Software Library page</p> <p>ARM Cortex™-M0 NuMicro® Family</p> <p>NuMicro® Family is Nuvoton's brand-new 32-bit Microcontroller product line based on the ARM® Cortex™-M0 processor with rich peripherals to offer superb features and connectivity capability. Besides the NUC100, NUC120, NUC130 and NUC140 series, a new series the NuMicro M051™ series, including the M052/54/58/516 is to satisfy the worldwide customers' 8-bit/16-bit microcontroller demand with a higher performance of a 32-bit microcontroller.</p> <div style="display: flex; justify-content: space-between;"> <div style="border: 1px solid gray; padding: 5px; width: 30%;"> <p style="text-align: center; background-color: #e0e0e0;">Technical Library</p> <ul style="list-style-type: none"> ▪ On-Line Products Selection Guide ▪ <u>Datasheet & Technical Reference Manual</u> ▪ <u>Software Library</u> ▪ Application Notes ▪ FAQ </div> <div style="border: 1px solid gray; padding: 5px; width: 30%;"> <p style="text-align: center; background-color: #e0e0e0;">Development Tools and Study</p> <ul style="list-style-type: none"> ▪ Development Tools & File Download ▪ Starter Kit ▪ On-Line Training </div> <div style="border: 1px solid gray; padding: 5px; width: 30%;"> <p style="text-align: center; background-color: #e0e0e0;">Information Notes</p> <ul style="list-style-type: none"> ▪ Events ▪ E-News ▪ M051 Series TRM New ▪ M051 Series BSP by CMSIS New ▪ NuMicro Keil uVision® IDE Driver New </div> </div> <p style="text-align: center; margin-top: 20px;">NuMicro® Family</p> <div style="display: flex; justify-content: space-around; align-items: center;"> <div style="border: 1px solid gray; padding: 5px; background-color: #f0f0f0;"> <p style="font-size: small;">M051 Base Line</p> <div style="display: flex; justify-content: space-between; font-size: x-small;"> Up to 64KB Flash ROM Up to 4KB SRAM </div> <p style="text-align: center; font-weight: bold; color: red;">• NuMicro M051 •</p> </div> <div style="border: 1px solid gray; padding: 5px; background-color: #c0c0c0;"> <p style="font-size: small;">Cortex-M0</p> <p style="font-size: x-small; text-align: center;">UART</p> </div> </div> <p style="font-size: x-small; margin-top: 5px;">NUC100 Advance Line</p>
Step 3	Download the NuMicro™ M051 series software library

7 Revision History

Version	Date	Page	Description
1.0	Oct. 21, 2010	--	Initial Release

Important Notice

Nuvoton products are not designed, intended, authorized or warranted for use as components in systems or equipment intended for surgical implantation, atomic energy control instruments, airplane or spaceship instruments, transportation instruments, traffic signal instruments, combustion control instruments, or for other applications intended to support or sustain life. Further more, Nuvoton products are not intended for applications wherein failure of Nuvoton products could result or lead to a situation wherein personal injury, death or severe property or environmental damage could occur.

Nuvoton customers using or selling these products for use in such applications do so at their own risk and agree to fully indemnify Nuvoton for any damages resulting from such improper use or sales.

Please note that all data and specifications are subject to change without notice. All the trademarks of products and companies mentioned in this datasheet belong to their respective owners.