



BIPOLAR ANALOG INTEGRATED CIRCUIT

μ PC3240TB

3.3 V, SILICON MMIC WIDE BAND AMPLIFIER

DESCRIPTION

The μ PC3240TB is a silicon monolithic integrated circuit designed as IF amplifier for DBS LNB.

This device exhibits low noise figure and high power gain characteristics.

This IC is manufactured using our UHS0 (Ultra High Speed Process) bipolar process.

FEATURES

- Low current : $I_{CC} = 13$ mA TYP.
- High linearity : $P_{O(1\text{ dB})} = +1$ dBm TYP. @ $f = 1.0$ GHz
: $P_{O(1\text{ dB})} = -4$ dBm TYP. @ $f = 2.2$ GHz
- Power gain : $G_P = 25$ dB TYP. @ $f = 1.0$ GHz
: $G_P = 24.5$ dB TYP. @ $f = 2.2$ GHz
- Gain flatness : $\Delta G_P = 1.0$ dB TYP. @ $f = 1.0$ to 2.2 GHz
- Noise figure : $NF = 4.3$ dB TYP. @ $f = 1.0$ GHz
: $NF = 4.5$ dB TYP. @ $f = 2.2$ GHz
- Supply voltage : $V_{CC} = 3.0$ to 3.6 V
- Port impedance : input/output 50Ω

APPLICATIONS

- IF amplifiers in DBS LNB, other L-band amplifiers, etc.

ORDERING INFORMATION

Part Number	Order Number	Package	Marking	Supplying Form
μ PC3240TB-E3	μ PC3240TB-E3-A	6-pin super minimold (Pb-Free)	C3W	<ul style="list-style-type: none">• Embossed tape 8 mm wide• Pin 1, 2, 3 face the perforation side of the tape• Qty 3 kpcs/reel

Remark To order evaluation samples, please contact your nearby sales office.

Part number for sample order: μ PC3240TB-A

Caution: Observe precautions when handling because these devices are sensitive to electrostatic discharge

The information in this document is subject to change without notice. Before using this document, please confirm that this is the latest version.

PIN CONNECTIONS AND INTERNAL BLOCK DIAGRAM

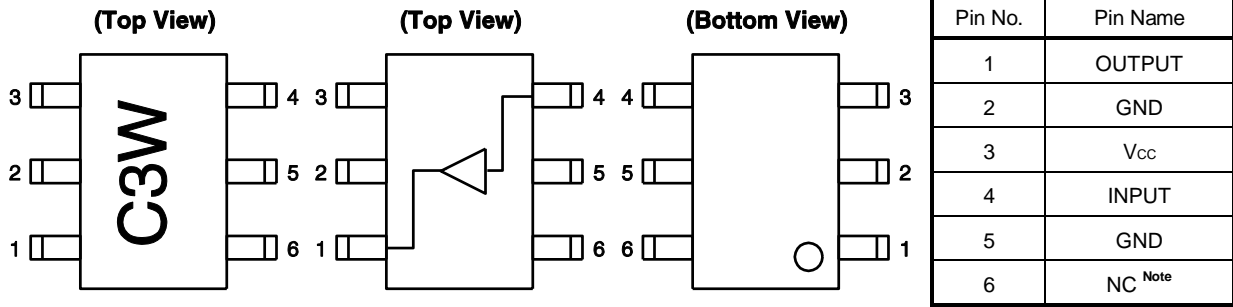

Note NC: Non-Connection
(Connect with pin 5)

Remark A NC pin is non-connection in the mold package. (When NC pin is open state, it will get influences of floating capacitance. Therefore, we recommend connect to NC pin and GND pin).

PRODUCT LINE-UP OF 5 V or 3.3 V-BIAS SILICON MMIC WIDE BAND AMPLIFIER
(T_A = +25°C, V_{CC} = 5.0 V or 3.3 V, Z_S = Z_L = 50 Ω)

Part No.	V _{CC} (V)	I _{CC} (mA)	G _P (dB)	NF (dB)	P _{O (sat)} (dBm)	P _{O (1 dB)} (dBm)	Package	Marking
μPC2711TB	5.0	12.0	13.0 (1.0 GHz)	5.0 (1.0 GHz)	+1.0 (1.0 GHz)	-	6-pin super minimold	C1G
μPC2712TB		12.0	20.0 (1.0 GHz)	4.5 (1.0 GHz)	+3.0 (1.0 GHz)	-		C1H
μPC3215TB		14.0	20.5 (1.5 GHz)	2.3 (1.5 GHz)	+3.5 (1.5 GHz)	+1.5 (1.5 GHz)		C3H
μPC3224TB		9.0	21.5 (1.0 GHz)	4.3 (1.0 GHz)	+4.0 (1.0 GHz)	-3.5 (1.0 GHz)		C3K
			21.5 (2.2 GHz)	4.3 (2.2 GHz)	+1.5 (2.2 GHz)	-5.5 (2.2 GHz)		
μPC3227TB	4.8	22.0 (1.0 GHz)	4.7 (1.0 GHz)	-1.0 (1.0 GHz)	-6.5 (1.0 GHz)	C3P		
		22.0 (2.2 GHz)	4.6 (2.2 GHz)	-3.5 (2.2 GHz)	-8.0 (2.2 GHz)			
μPC3240TB	3.3	13.0	25 (1.0 GHz)	4.3 (1.0 GHz)	-	+1.0 (1.0 GHz)	C3W	
			24.5 (2.2 GHz)	4.5 (2.2 GHz)	-	-4.0 (2.2 GHz)		

Remark Typical performance. Please refer to **ELECTRICAL CHARACTERISTICS** in detail.

ABSOLUTE MAXIMUM RATINGS

Parameter	Symbol	Conditions	Ratings	Unit
Supply Voltage	V _{CC}	T _A = +25°C	4.0	V
Total Circuit Current	I _{CC}	T _A = +25°C	25	mA
Power Dissipation	P _D	T _A = +85°C Note	270	mW
Operating Ambient Temperature	T _A		-40 to +85	°C
Storage Temperature	T _{stg}		-55 to +150	°C
Input Power	P _{in}	T _A = +25°C	-10	dBm

Note Mounted on double-sided copper-clad 50 × 50 × 1.6 mm epoxy glass PWB

RECOMMENDED OPERATING RANGE

Parameter	Symbol	Conditions	MIN.	TYP.	MAX.	Unit
Supply Voltage	V _{CC}		3.0	3.3	3.6	V
Operating Ambient Temperature	T _A		-40	+25	+85	°C
Input Power	P _{in}		-	-	-20	dBm

ELECTRICAL CHARACTERISTICS (T_A = +25°C, V_{CC} = 3.3 V, Z_S = Z_L = 50 Ω, unless otherwise specified)

Parameter	Symbol	Test Conditions	MIN.	TYP.	MAX.	Unit
Circuit Current	I _{CC}	No input signal	9.5	13	17	mA
Power Gain 1	G _{P1}	f = 0.25 GHz, P _{in} = -40 dBm	22	25	28	dB
Power Gain 2	G _{P2}	f = 1.0 GHz, P _{in} = -40 dBm	22	25	28	
Power Gain 3	G _{P3}	f = 1.8 GHz, P _{in} = -40 dBm	22.5	25.5	28.5	
Power Gain 4	G _{P4}	f = 2.2 GHz, P _{in} = -40 dBm	21.5	24.5	27.5	
Gain 1 dB Compression Output Power 1	P _{O(1 dB)1}	f = 1.0 GHz	-2	+1	-	dBm
Gain 1 dB Compression Output Power 2	P _{O(1 dB)2}	f = 2.2 GHz	-7	-4	-	
Noise Figure 1	NF1	f = 1.0 GHz	-	4.3	5.1	dB
Noise Figure 2	NF2	f = 2.2 GHz	-	4.5	5.3	
Isolation 1	ISL1	f = 1.0 GHz, P _{in} = -40 dBm	37	42	-	dB
Isolation 2	ISL2	f = 2.2 GHz, P _{in} = -40 dBm	37	44	-	
Input Return Loss 1	RL _{in1}	f = 1.0 GHz, P _{in} = -40 dBm	10	23	-	dB
Input Return Loss 2	RL _{in2}	f = 2.2 GHz, P _{in} = -40 dBm	10	13	-	
Output Return Loss 1	RL _{out1}	f = 1.0 GHz, P _{in} = -40 dBm	8	12	-	dB
Output Return Loss 2	RL _{out2}	f = 2.2 GHz, P _{in} = -40 dBm	7	12	-	

STANDARD CHARACTERISTICS FOR REFERENCE

(T_A = +25°C, V_{CC} = 3.3 V, Z_S = Z_L = 50 Ω, unless otherwise specified)

Parameter	Symbol	Test Conditions	Reference Value	Unit
Power Gain 5	G _{P5}	f = 2.6 GHz, P _{in} = -40 dBm	22.5	dB
Power Gain 6	G _{P6}	f = 3.0 GHz, P _{in} = -40 dBm	20	
Gain Flatness	ΔG _P	f = 1.0 to 2.2 GHz, P _{in} = -40 dBm	1.0	dB
K factor 1	K1	f = 1.0 GHz, P _{in} = -40 dBm	3.2	-
K factor 2	K2	f = 2.2 GHz, P _{in} = -40 dBm	4.6	-
Output 3rd Order Intercept Point 1	OIP ₃₁	f1 = 1 000 MHz, f2 = 1 001 MHz	12.5	dBm
Output 3rd Order Intercept Point 2	OIP ₃₂	f1 = 2 200 MHz, f2 = 2 201 MHz	5.5	
Input 3rd Order Intercept Point 1	IIP ₃₁	f1 = 1 000 MHz, f2 = 1 001 MHz	-13	dBm
Input 3rd Order Intercept Point 2	IIP ₃₂	f1 = 2 200 MHz, f2 = 2 201 MHz	-19	
2nd Order Intermodulation Distortion	IM ₂	f1 = 1 000 MHz, f2 = 1 001 MHz, P _{in} = -40 dBm/tone	38	dBc
2nd Harmonics	2f ₀	f ₀ = 1.0 GHz, P _{in} = -40 dBm	44	dBc

TEST CIRCUIT

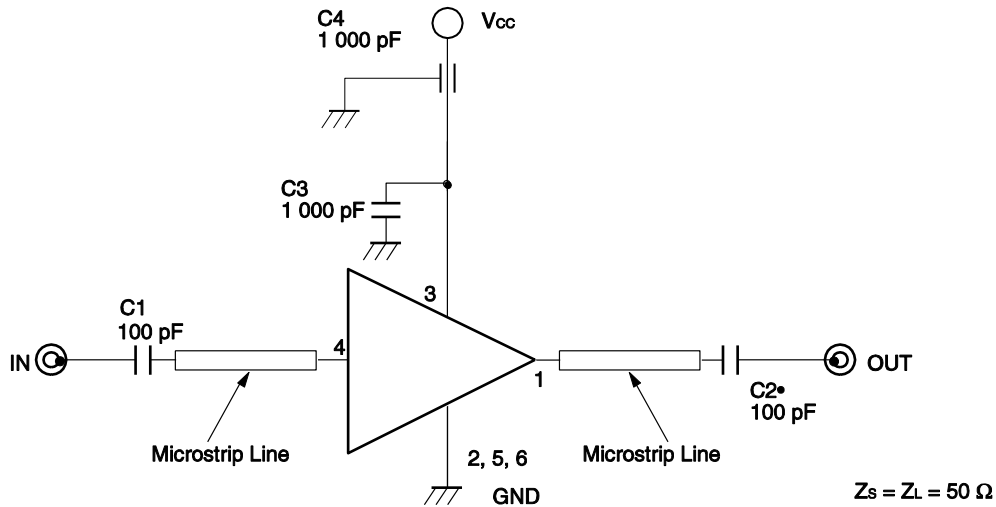

The application circuits and their parameters are for reference only and are not intended for use in actual design-ins.

COMPONENTS OF TEST CIRCUIT FOR MEASURING ELECTRICAL CHARACTERISTICS

	Type	Value
C1, C2	Chip Capacitor	100 pF
C3	Chip Capacitor	1 000 pF
C4	Feed-through Capacitor	1 000 pF

CAPACITORS FOR THE Vcc, INPUT AND OUTPUT PINS

Capacitors of 1 000 pF are recommendable as the bypass capacitor for the Vcc pin and the coupling capacitors for the input and output pins.

The bypass capacitor connected to the Vcc pin is used to minimize ground impedance of Vcc pin. So, stable bias can be supplied against Vcc fluctuation.

The coupling capacitors, connected to the input and output pins, are used to cut the DC and minimize RF serial impedance. Their capacitances are therefore selected as lower impedance against a 50 Ω load. The capacitors thus perform as high pass filters, suppressing low frequencies to DC.

ILLUSTRATION OF THE TEST CIRCUIT ASSEMBLED ON EVALUATION BOARD

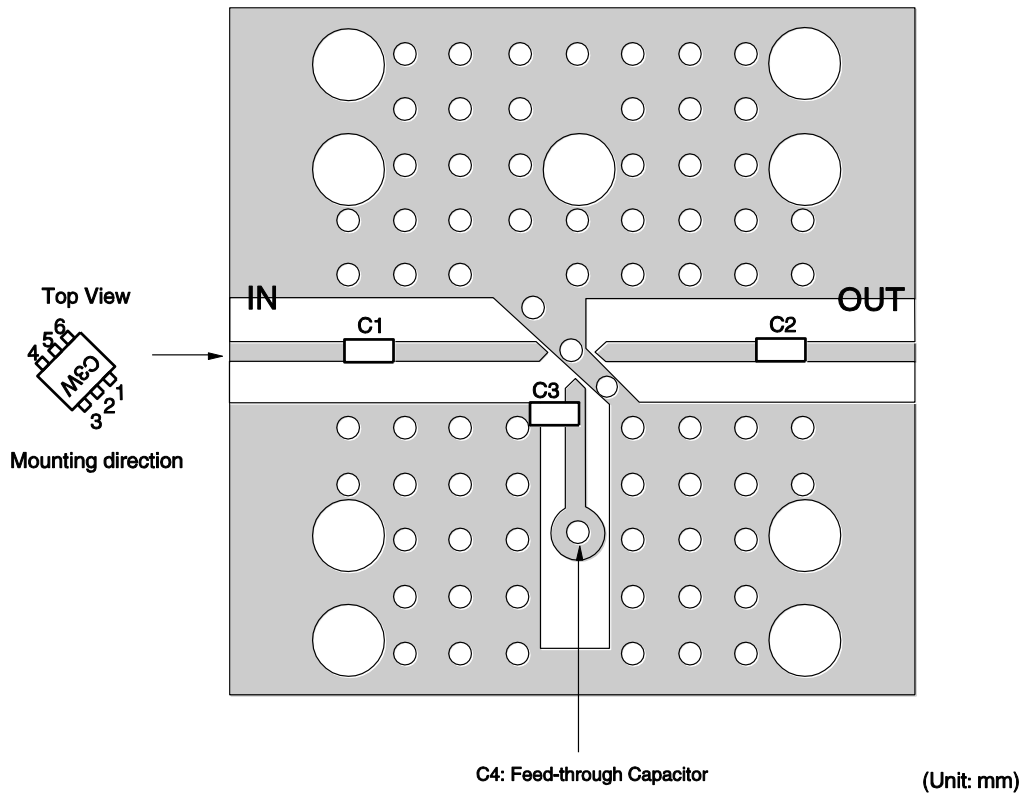

COMPONENT LIST

	Value	Size
C1, C2	100 pF	1608
C3	1 000 pF	1005
C4	1 000 pF	Feed-through Capacitor

Notes

1. 30 × 30 × 0.4 mm double sided 35 μm copper clad polyimide board.
2. Back side: GND pattern
3. Au plated on pattern
4. ◦○: Through holes

TYPICAL CHARACTERISTICS ($T_A = +25^\circ\text{C}$, $V_{CC} = 3.3\text{ V}$, $Z_S = Z_L = 50\ \Omega$, unless otherwise specified)

CIRCUIT CURRENT vs. SUPPLY VOLTAGE

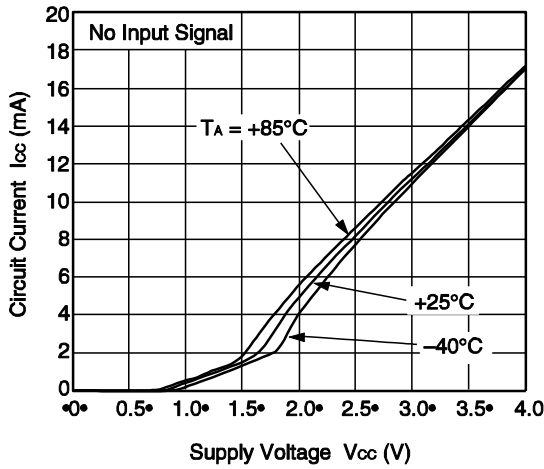

CIRCUIT CURRENT vs. OPERATING AMBIENT TEMPERATURE

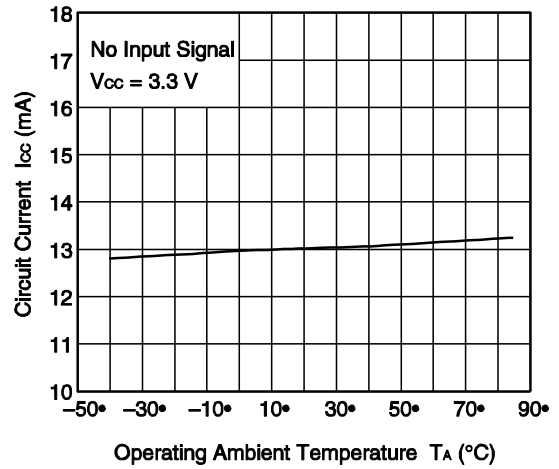

POWER GAIN vs. FREQUENCY

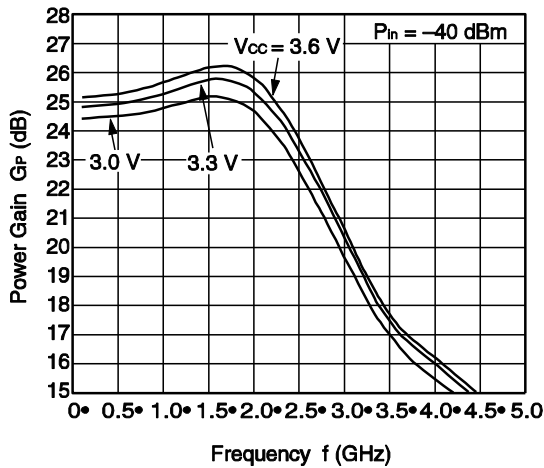

INPUT RETURN LOSS vs. FREQUENCY

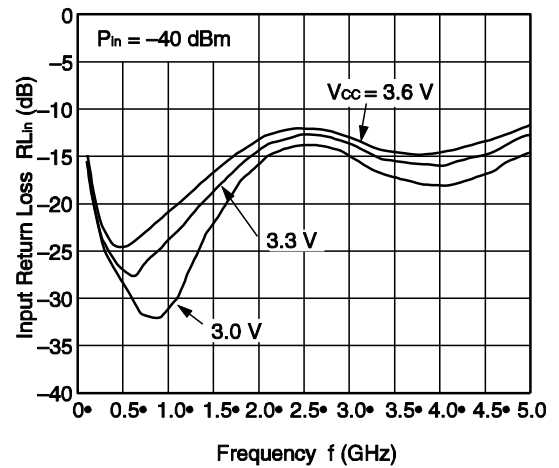

ISOLATION vs. FREQUENCY

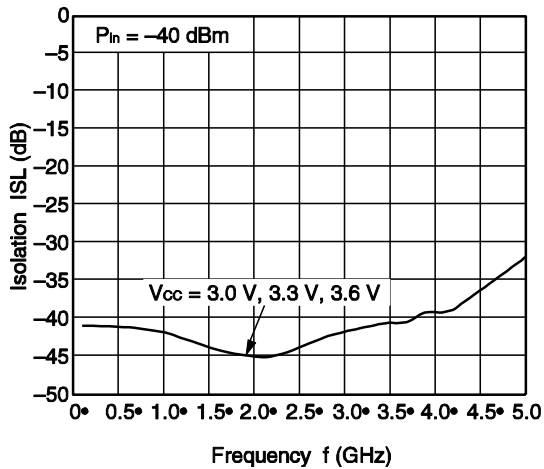

OUTPUT RETURN LOSS vs. FREQUENCY

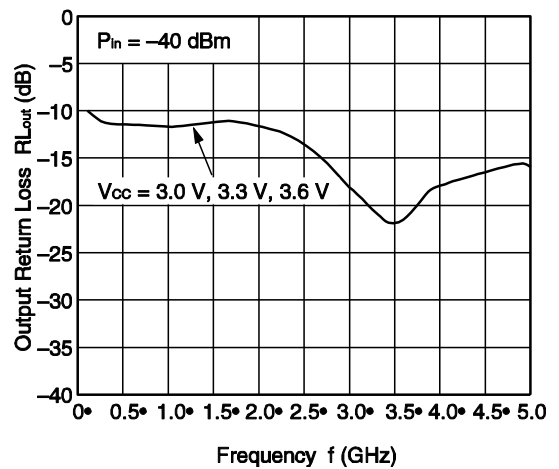

Remark The graphs indicate nominal characteristics.

POWER GAIN vs. FREQUENCY

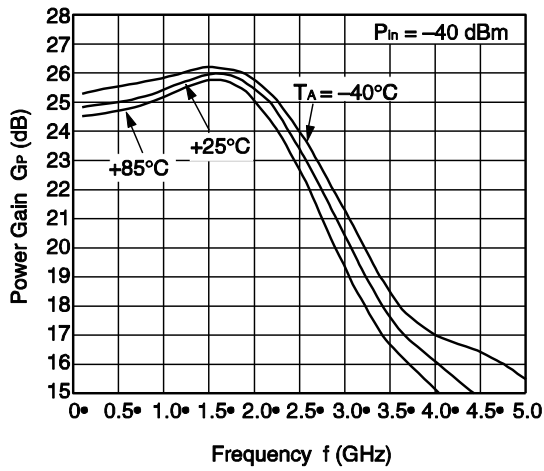

INPUT RETURN LOSS vs. FREQUENCY

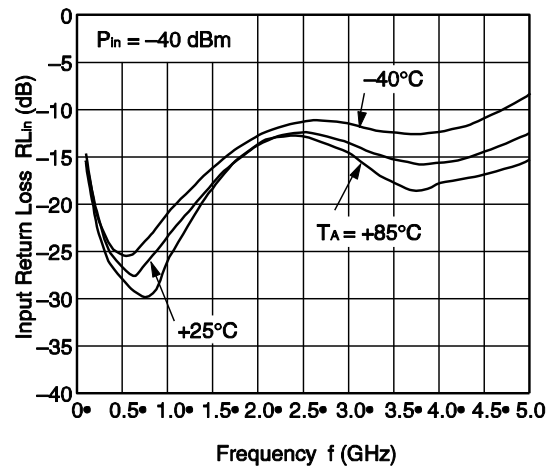

ISOLATION vs. FREQUENCY

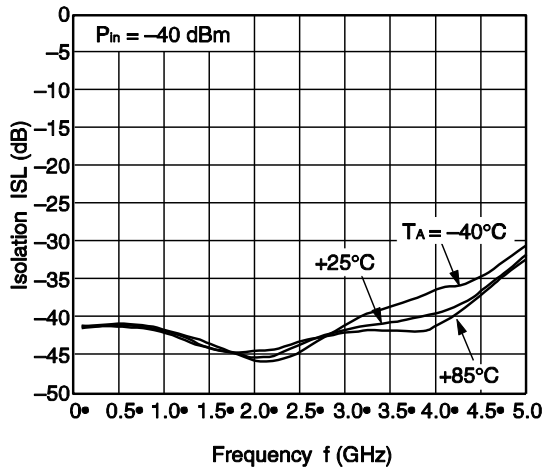

OUTPUT RETURN LOSS vs. FREQUENCY

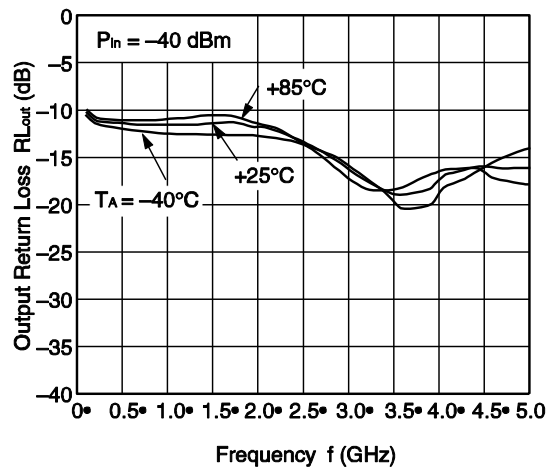

OUTPUT POWER vs. INPUT POWER

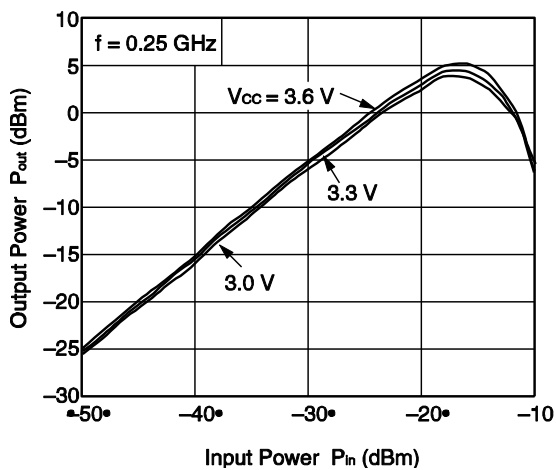

OUTPUT POWER vs. INPUT POWER

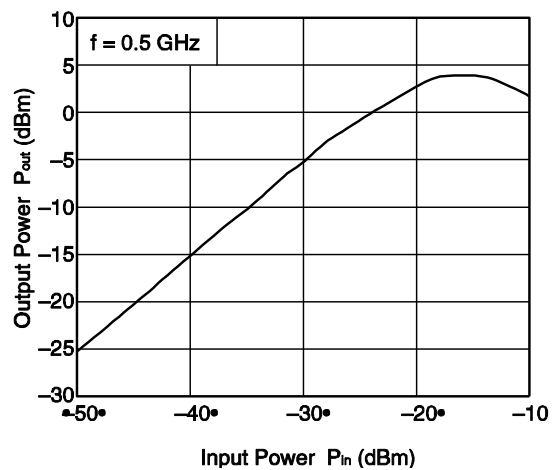

Remark The graphs indicate nominal characteristics.

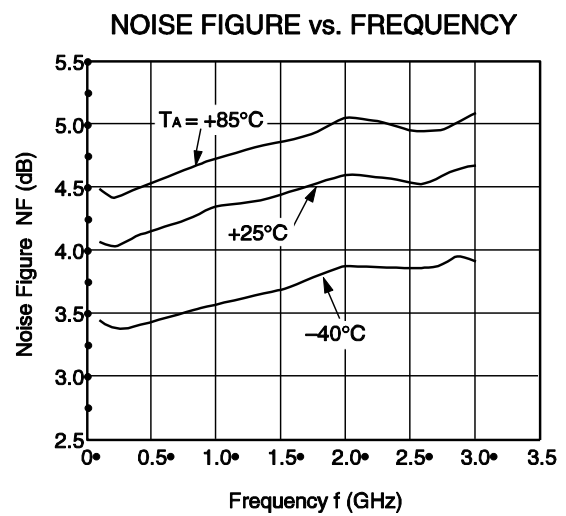
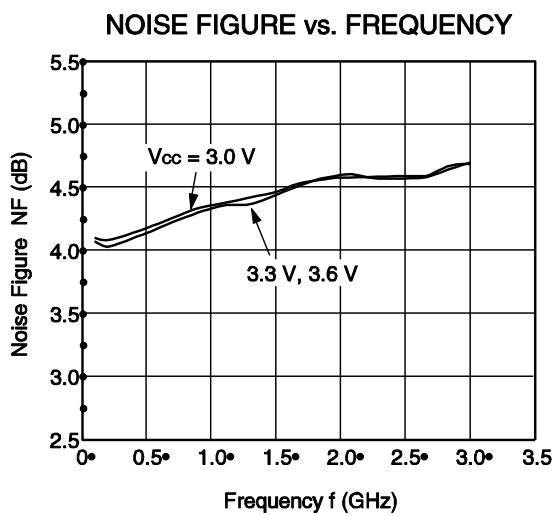
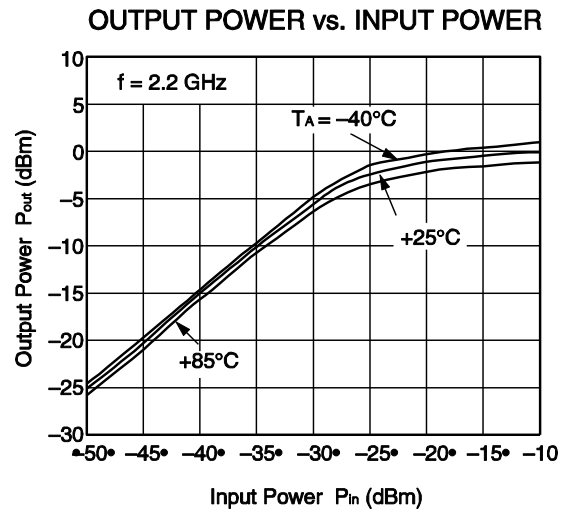
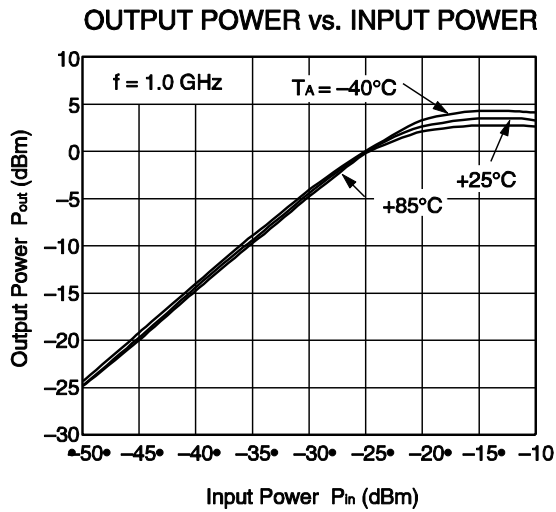
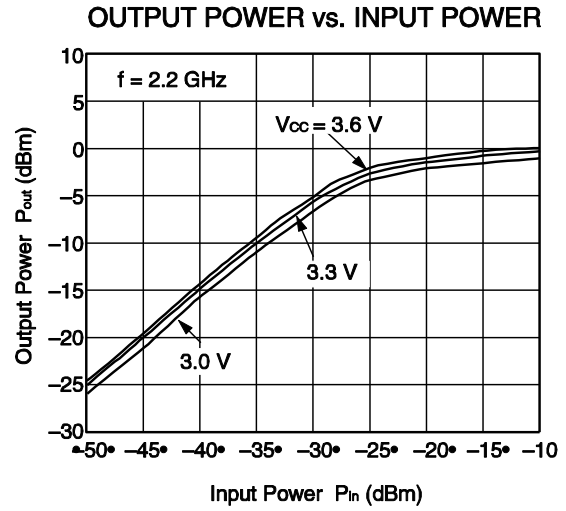
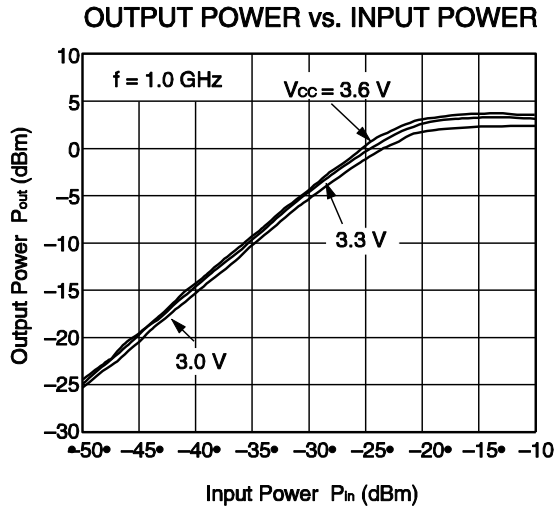

Remark The graphs indicate nominal characteristics.

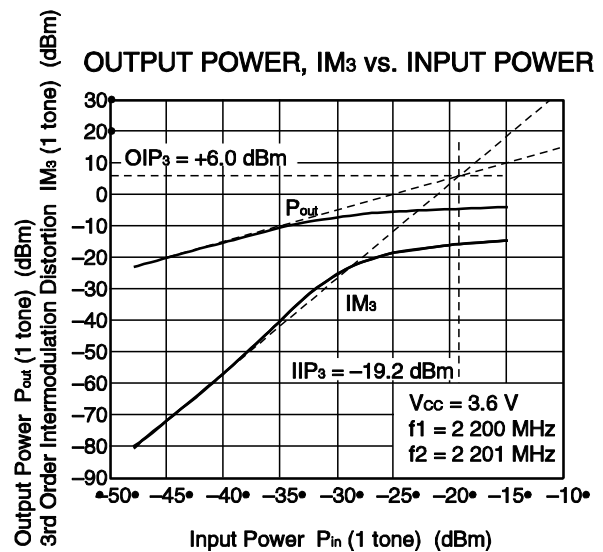
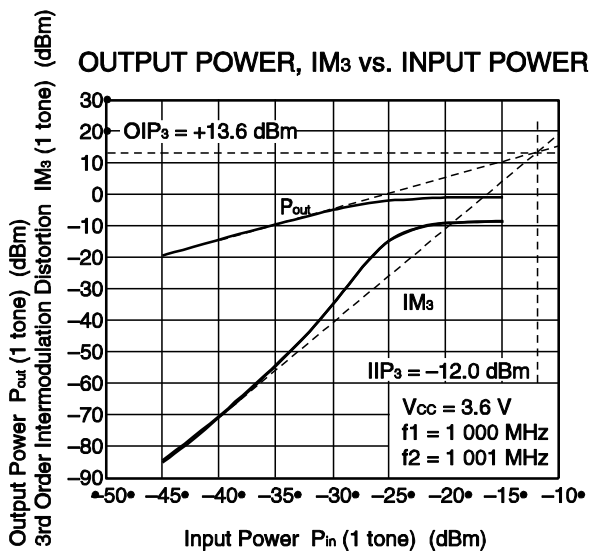
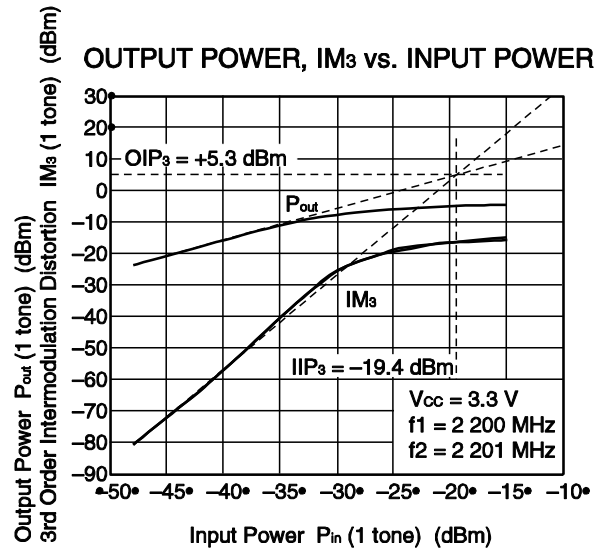
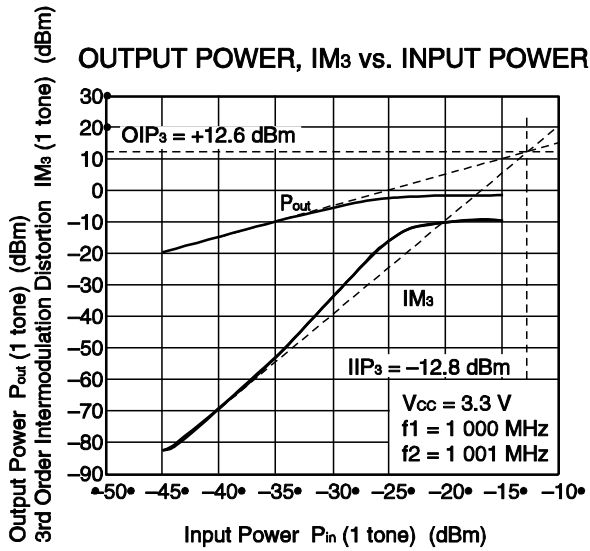
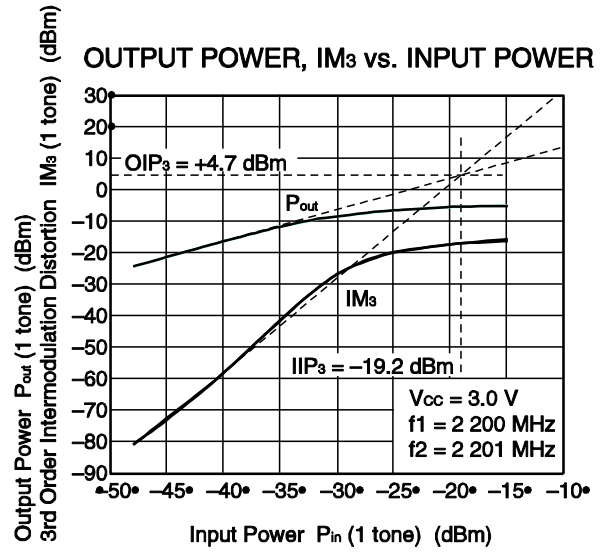
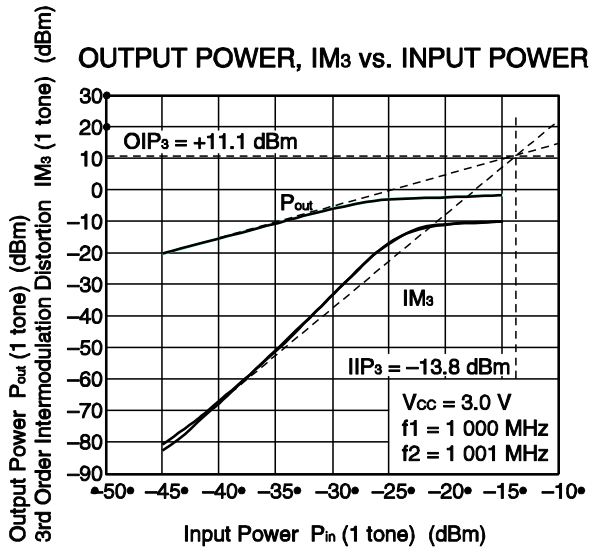

Remark The graphs indicate nominal characteristics.

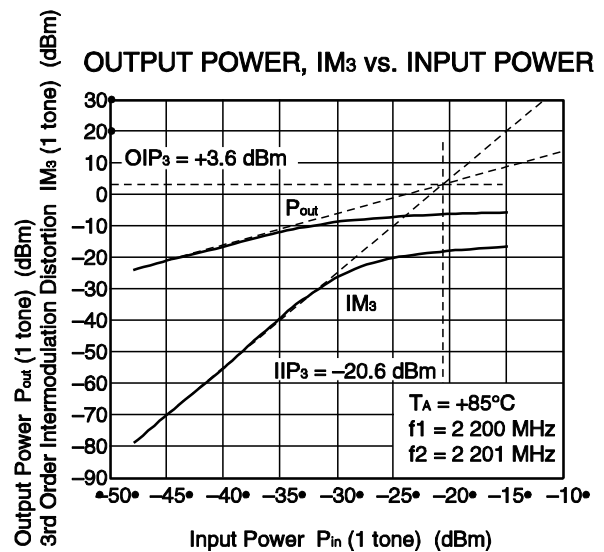
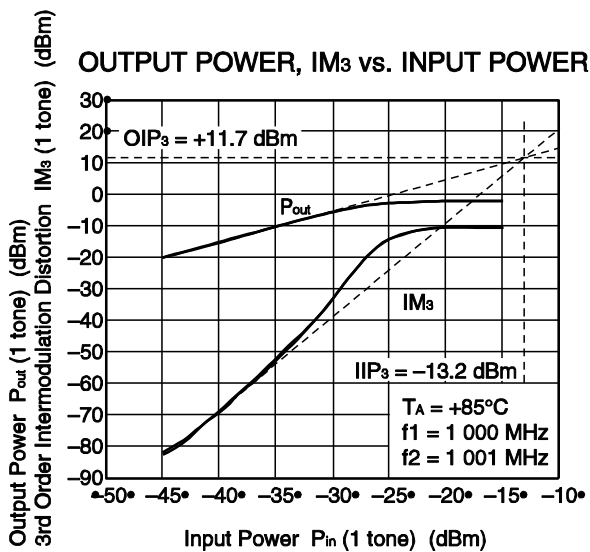
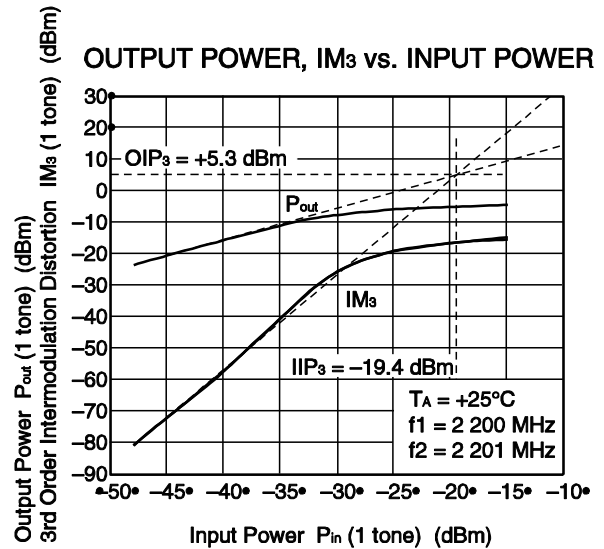
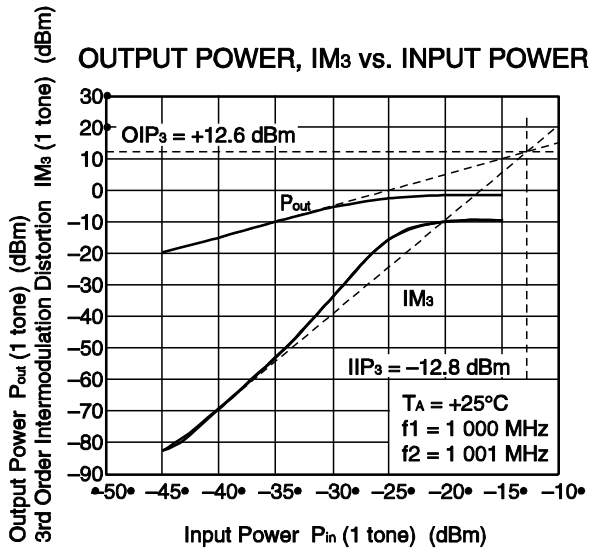
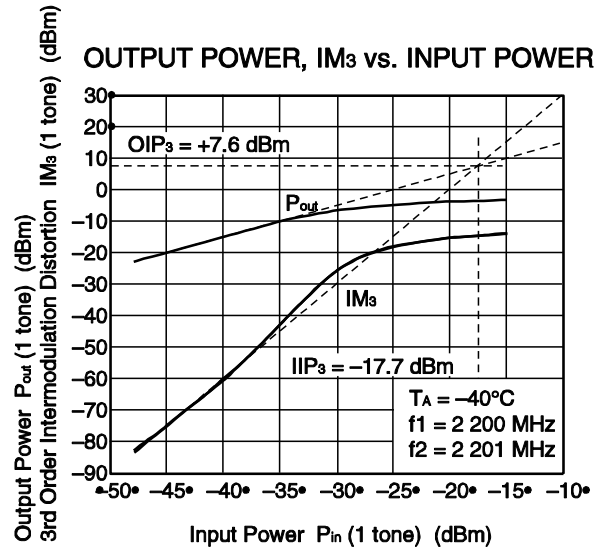
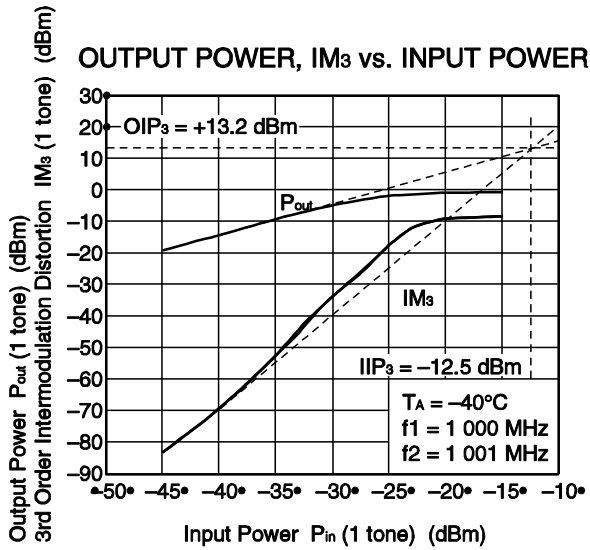

Remark The graphs indicate nominal characteristics.

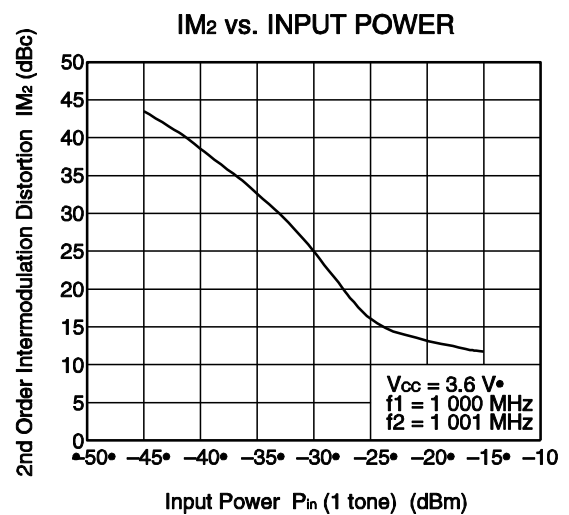
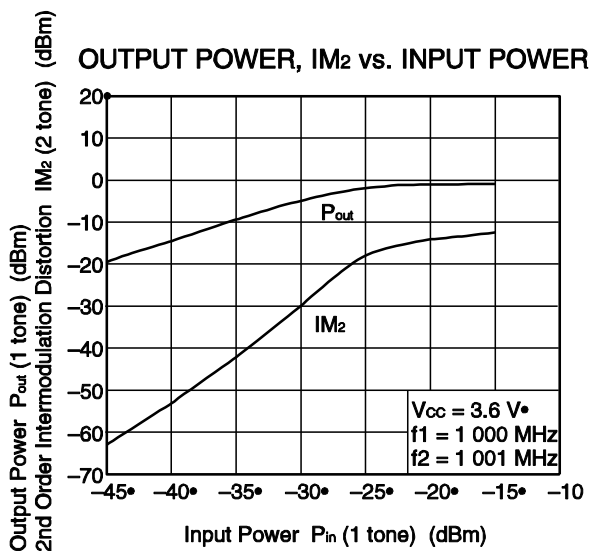
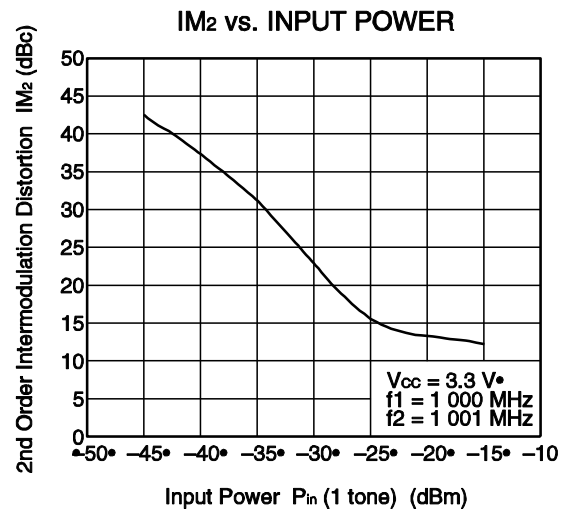
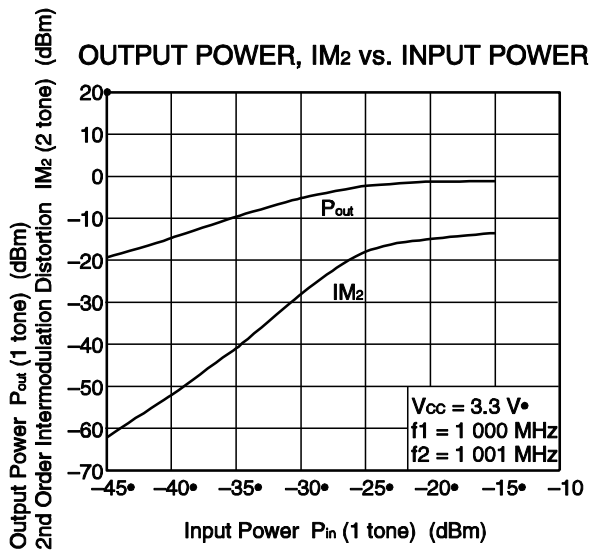
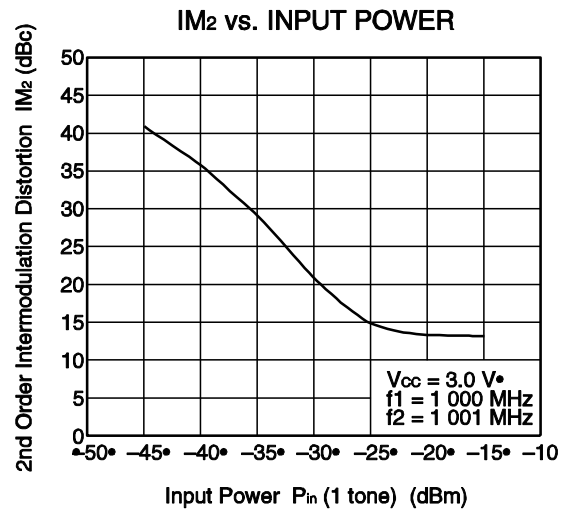
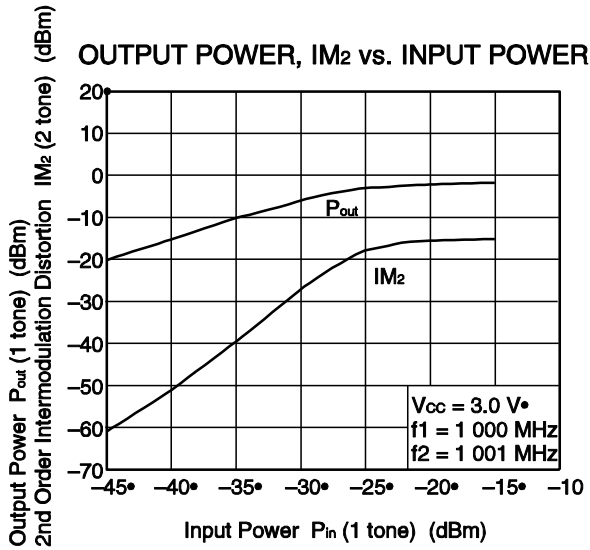

Remark The graphs indicate nominal characteristics.

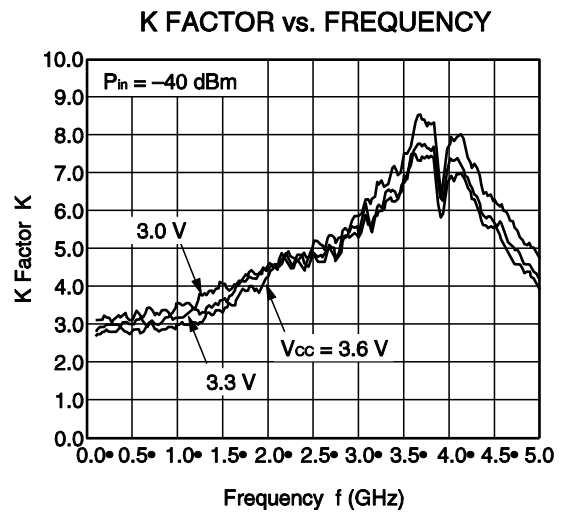
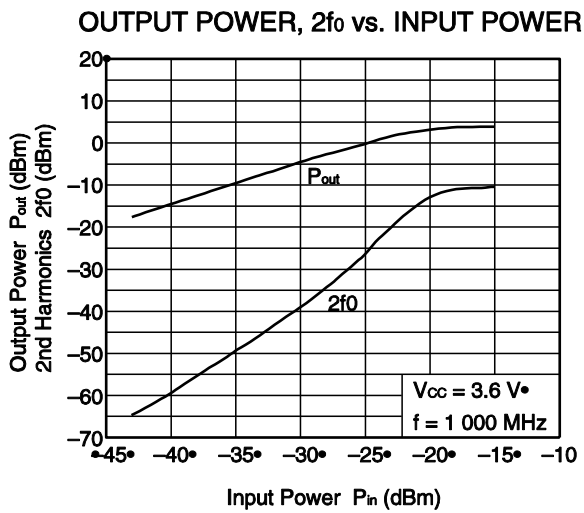
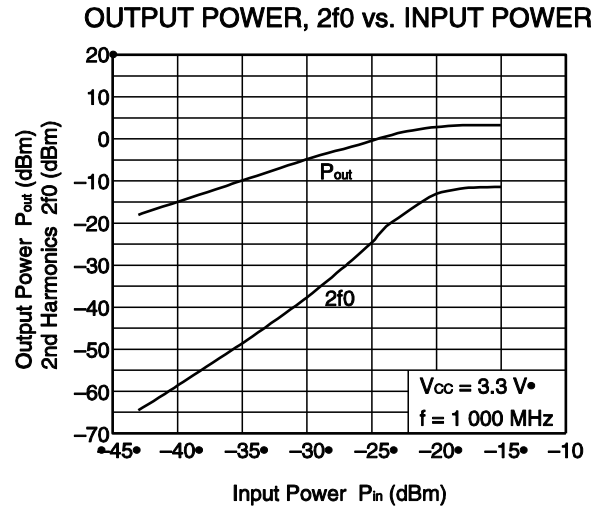
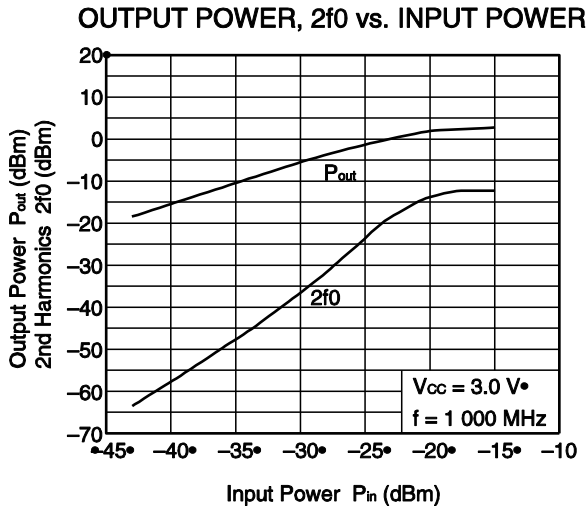

Remark The graphs indicate nominal characteristics.

S-PARAMETERS ($T_A = +25^\circ\text{C}$, $V_{CC} = 3.3\text{ V}$, $P_{in} = -40\text{ dBm}$)

S₁₁-FREQUENCY

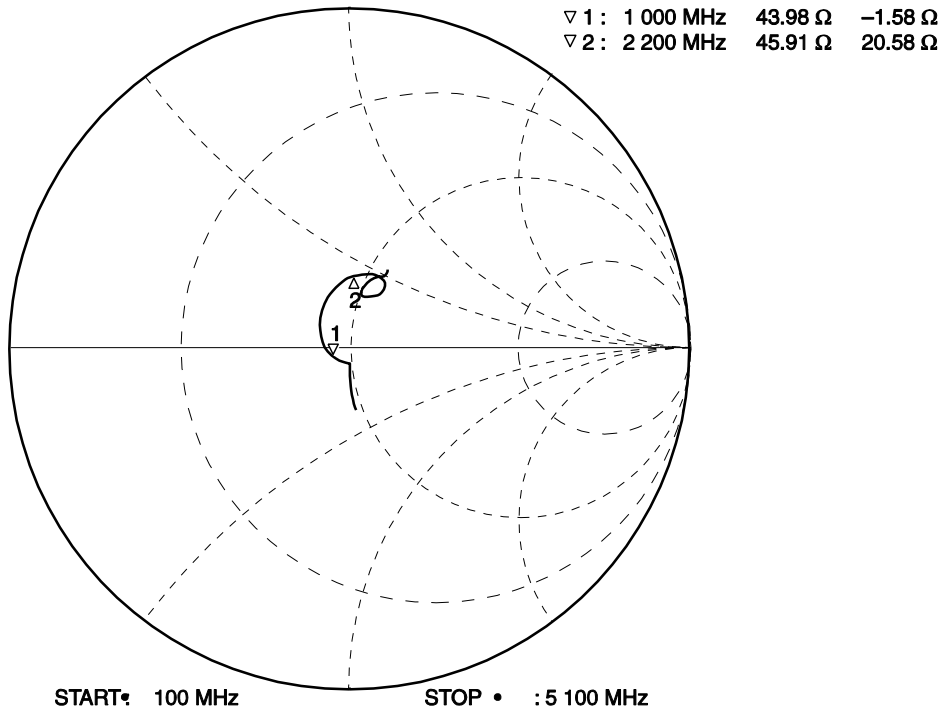

S₂₂-FREQUENCY

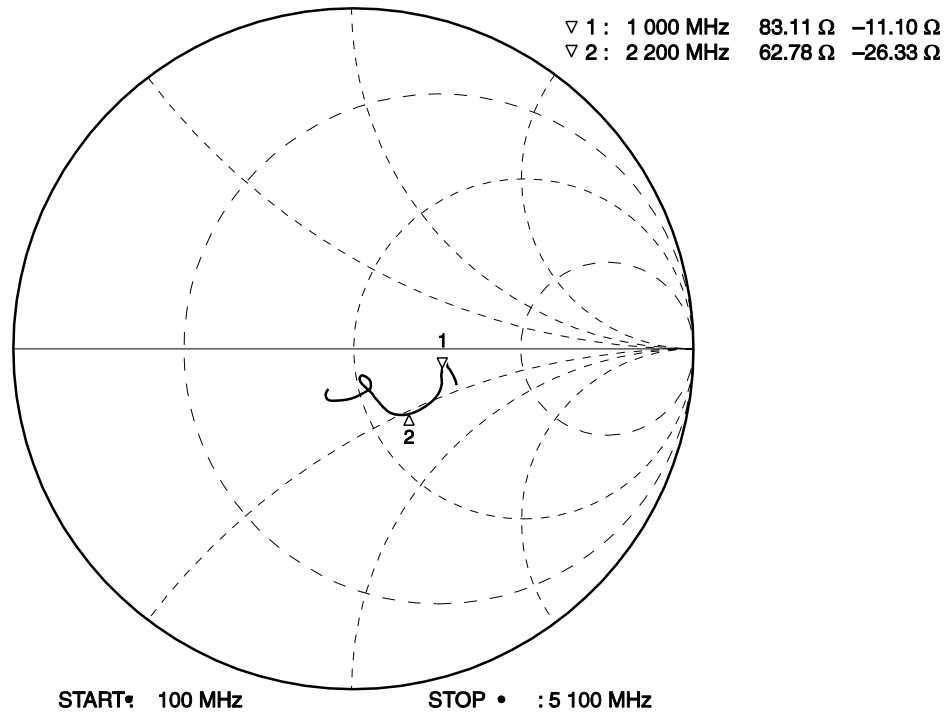

Remarks 1. Measured on the test circuit of evaluation board.

2. The graphs indicate nominal characteristics.

S-PARAMETERS

- S-parameters and noise parameters are provided on our Web site in a format (S2P) that enables the direct import of the parameters to microwave circuit simulators without the need for keyboard inputs.
- [Click here to download S-parameters.](#)
- [RF and Microwave] ® [Device Parameters]
- URL <http://www.necel.com/microwave/en/>

PACKAGE DIMENSIONS

6-PIN SUPER MINIMOLD (UNIT: mm)

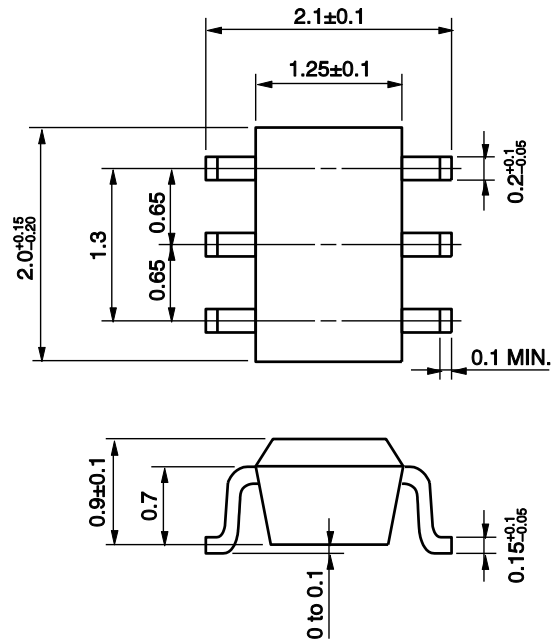

NOTES ON CORRECT USE

- (1) Observe precautions for handling because of electro-static sensitive devices.
- (2) Form a ground pattern as widely as possible to minimize ground impedance (to prevent undesired oscillation).
All the ground terminals must be connected together with wide ground pattern to decrease impedance difference.
- (3) The bypass capacitor should be attached to the V_{cc} line.
- (4) The DC cut capacitor must be attached to input and output pin.

RECOMMENDED SOLDERING CONDITIONS

This product should be soldered and mounted under the following recommended conditions. For soldering methods and conditions other than those recommended below, contact your nearby sales office.

Soldering Method	Soldering Conditions	Condition Symbol
Infrared Reflow	Peak temperature (package surface temperature) : 260°C or below Time at peak temperature : 10 seconds or less Time at temperature of 220°C or higher : 60 seconds or less Preheating time at 120 to 180°C : 120±30 seconds Maximum number of reflow processes : 3 times Maximum chlorine content of rosin flux (% mass) : 0.2%(Wt.) or below	IR260
Wave Soldering	Peak temperature (molten solder temperature) : 260°C or below Time at peak temperature : 10 seconds or less Preheating temperature (package surface temperature) : 120°C or below Maximum number of flow processes : 1 time Maximum chlorine content of rosin flux (% mass) : 0.2%(Wt.) or below	WS260
Partial Heating	Peak temperature (terminal temperature) : 350°C or below Soldering time (per side of device) : 3 seconds or less Maximum chlorine content of rosin flux (% mass) : 0.2%(Wt.) or below	HS350

Caution Do not use different soldering methods together (except for partial heating).