

3.3V, HD/SD Triple-Channel Filter Amplifiers with Shutdown

General Description

The MAX9652/MAX9653/MAX9654 are 3.3V, triple-channel, high-definition (HD) video-filter amplifiers. Specially designed for YPbPr component video signals, these devices are ideal for a wide range of set-top box and portable applications. The inputs to the MAX9652/MAX9653/MAX9654 are AC-coupled. YIN has a sync-tip clamp while PBIN and PRIN have keyed clamps. The output buffer has gain of 2V/V and drives a standard back-terminated 75Ω video load.

The passband of the MAX9654 is logic selectable between standard definition (SD) and high definition. The MAX9652/MAX9653 have a fixed passband for HD video. The MAX9654 SD lowpass filter has ±1dB passband out to 8.5MHz and 57dB attenuation at 27MHz. The MAX9652/MAX9653/MAX9654 HD lowpass filter have ±1dB passband out to 42MHz and 50dB attenuation at 109MHz.

The devices consume only 9.5mA per channel and operate from a 3.3V supply. The MAX9653/MAX9654 feature a low-power, 12μA shutdown mode. The MAX9652/MAX9653/MAX9654 are specified over the -40°C to +125°C automotive temperature range.

Applications

Set-Top Boxes	PVR
DVD Players	DVC
HDTV	

Features

- ◆ 9.5mA/Channel Supply Current
- ◆ Selectable Lowpass Filter for High-Definition or Standard-Definition Video Signals (MAX9654)
- ◆ 8.5MHz Standard-Definition Passband with 57dB Attenuation at 27MHz
- ◆ 42MHz High-Definition Passband with 50dB Attenuation at 109MHz
- ◆ 2V/V Gain
- ◆ 3.135V to 3.465V Single-Supply Operation
- ◆ 12μA Shutdown Mode (MAX9653/MAX9654)

Ordering Information

PART	PIN-PACKAGE	FILTER	SHUTDOWN
MAX9652ASA+T	8 SO	HD	No
MAX9653AUB+T	10 μMAX	HD	Yes
MAX9654AUB+T	10 μMAX	SD/HD	Yes

Note: All devices are specified over the -40°C to +125°C operating temperature range.

+ Denotes a lead-free/RoHS-compliant package.

T = Tape and reel.

Typical Application Circuit

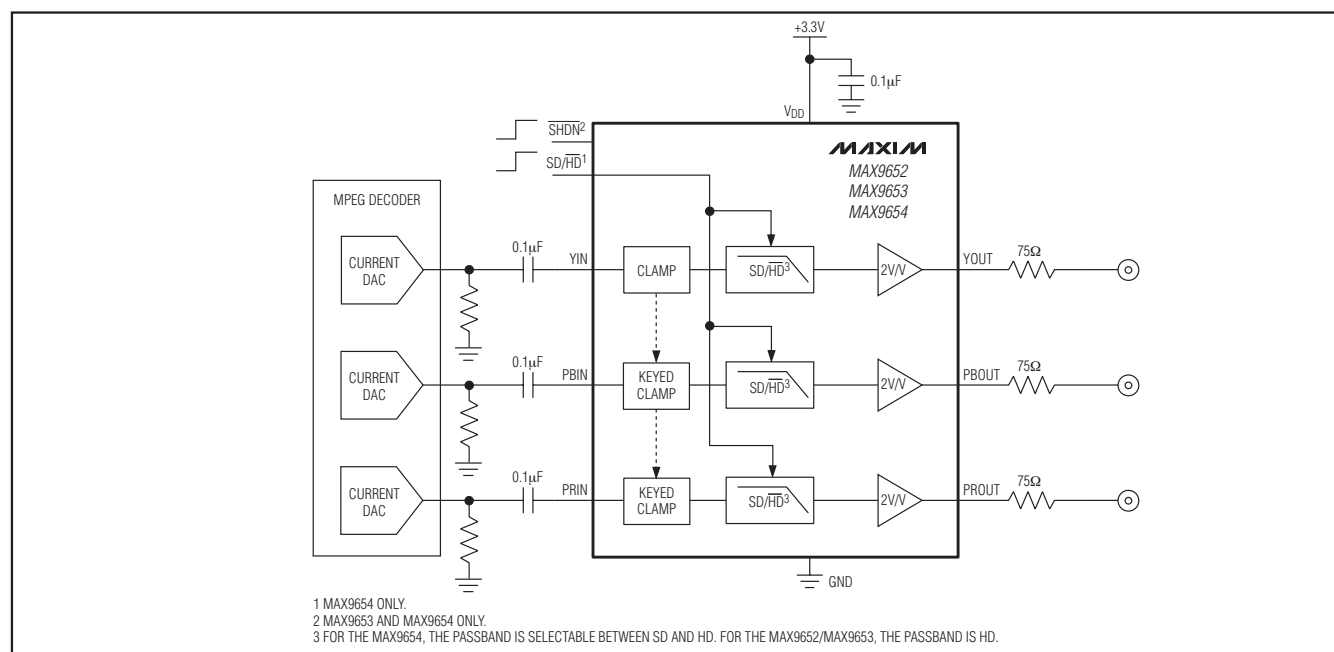

3.3V, HD/SD Triple-Channel Filter Amplifiers with Shutdown

ABSOLUTE MAXIMUM RATINGS

V _{DD} to GND	-0.3V to +4V
YIN, PRIN, PBIN to GND	-0.3V to (V _{DD} + 0.3V)
SHDN, SD/HD to GND	-0.3V to +4V
Maximum Current into Any Input Pin	±20mA
Output Short-Circuit Current Duration to V _{DD} or GND	Continuous
Continuous Power Dissipation (T _A = +70°C)	
8-Pin SO (derate 5.9mW/°C above +70°C)	471mW
10-Pin μMAX (derate 5.6mW/°C above +70°C)	444mW

Operating Temperature Range	-40°C to +125°C
Junction Temperature	+150°C
Storage Temperature Range	-65°C to +150°C
Lead Temperature (soldering, 10s)	+300°C

Stresses beyond those listed under "Absolute Maximum Ratings" may cause permanent damage to the device. These are stress ratings only, and functional operation of the device at these or any other conditions beyond those indicated in the operational sections of the specifications is not implied. Exposure to absolute maximum rating conditions for extended periods may affect device reliability.

ELECTRICAL CHARACTERISTICS

(V_{DD} = 3.3V, V_{SHDN} = V_{DD}, V_{GND} = 0, no load, T_A = T_{MIN} to T_{MAX}, unless otherwise noted. Typical values are at T_A = +25°C.) (Note 1)

PARAMETER	SYMBOL	CONDITIONS	MIN	TYP	MAX	UNITS
DC CHARACTERISTICS						
Supply Voltage Range	V _{DD}	Guaranteed by PSRR	3.135	3.3	3.465	V
Quiescent Supply Current	I _{DD}	No load		28.9	45	mA
Shutdown Supply Current		SHDN = GND for MAX9653/MAX9654		12	20	μA
Input Voltage		SHDN = GND for MAX9653/MAX9654	0.3 x V _{DD}	V _{DD} /3	0.36 x V _{DD}	V
Input Resistance (YIN, PBIN, PRIN)		SHDN = GND for MAX9653/MAX9654	105	210	310	kΩ
INPUT						
Input Voltage Swing	V _{SWING}	Guaranteed by output voltage swing	Y input		1.3	V _{P-P}
			PB input, PR input		1	
YIN Sync Tip Clamp Level	V _{CCLP}		0.28	0.34	0.4	V
YIN Input Clamping Current	I _{CCLP}	V _{YIN} = V _{CCLP} + 0.5V		0.62	2.2	μA
YIN Sync Crush		YIN sync-tip clamp % reduction in sync pulse from 0.3V; R _{SOURCE} = 75Ω	Standard definition		0.3	%
			High definition		0.7	
PBIN, PRIN Input Bias Level	V _{BIAS}		0.84	0.915	1	V
PBIN, PRIN Input Resistance		Normal operation, V _{SHDN} = V _{DD}		20		kΩ
OUTPUT						
Voltage Gain (Note 2)	A _V	Guaranteed by output voltage swing	1.95	2	2.04	V/V
Gain Matching		Guaranteed by output voltage swing	-2	0	+2	%
Output Level		Sync-tip clamp, YIN = unconnected, measured at YOUT	0.21	0.31	0.41	V
		PBIN = PRIN = unconnected, measured at PBOUT, PROUT	1.1	1.32	1.5	V

3.3V, HD/SD Triple-Channel Filter Amplifiers with Shutdown

MAX9652/MAX9653/MAX9654

ELECTRICAL CHARACTERISTICS (continued)

($V_{DD} = 3.3V$, $V_{SHDN} = V_{DD}$, $V_{GND} = 0$, no load, $T_A = T_{MIN}$ to T_{MAX} , unless otherwise noted. Typical values are at $T_A = +25^\circ C$.) (Note 1)

PARAMETER	SYMBOL	CONDITIONS	MIN	TYP	MAX	UNITS	
Output Voltage Swing (Note 2)		$3.135V \leq V_{DD} \leq 3.465V$, measured at output: $V_{YIN} = V_{CLP}$ to $(V_{CLP} + 1.3V)$, $V_{PBIN} = V_{PRIN} = (V_{BIAS} - 0.35V)$ to $(V_{BIAS} + 0.65V)$, $V_{YIN} = 1.3V_{P-P}$, $V_{PRIN} = V_{PRIN} = 1.0V_{P-P}$	Y_{OUT} , $R_L = 150\Omega$ to $V_{DD}/2$	2.535	2.6	2.652	V_{P-P}
		Y_{OUT} , $R_L = 150\Omega$ to GND					
		P_{BOUT} , P_{ROUT} , $R_L = 150\Omega$ to $V_{DD}/2$	1.95	2.0	2.04		
		P_{BOUT} , P_{ROUT} , $R_L = 150\Omega$ to GND					
Output Resistance		Normal operation; $V_{SHDN} = V_{DD}$ for MAX9653/MAX9654		0.5		Ω	
Output Leakage		Shutdown; $V_{SHDN} = GND$ for MAX9653/MAX9654; $T_A = +25^\circ C$		0.1	10	μA	
Power-Supply Rejection Ratio		$3.135V \leq V_{DD} \leq 3.465V$	40	57		dB	
LOGIC INPUTS							
Logic-Low Threshold	V_{IL}	$T_A = +25^\circ C$	$0.3 \times V_{DD}$			V	
Logic-High Threshold	V_{IH}	$T_A = +25^\circ C$			$0.7 \times V_{DD}$	V	
Logic-Input Current	I_{IL}/I_{IH}	$V_{IN} = GND$ to V_{DD} ; $T_A = +25^\circ C$		0.01	10	μA	
HIGH DEFINITION							
High-Definition Reconstruction Filter		± 1 dB passband flatness		42		MHz	
		$V_{IN} = 1V_{P-P}$, reference frequency is 1MHz	$f = 30MHz$	0.4		dB	
			$f = 50MHz$	-3			
			$f = 109MHz$	-50			
K2T		Taken with Tektronix VM5000HD using a standard matrix signal		0.62		%	
Nonlinearity		5-step staircase		0.71		%	
Interchannel Time Error		Difference in time between the 50% point of the output signals; $V_{IN} = 0.5V_{P-P}$, Y to Pb and Y to Pr		1		ns	
Group Delay Distortion		$100kHz \leq f \leq 30MHz$, $V_{IN} = 1V_{P-P}$		7		ns	

3.3V, HD/SD Triple-Channel Filter Amplifiers with Shutdown

ELECTRICAL CHARACTERISTICS (continued)

($V_{DD} = 3.3V$, $V_{SHDN} = V_{DD}$, $V_{GND} = 0$, no load, $T_A = T_{MIN}$ to T_{MAX} , unless otherwise noted. Typical values are at $T_A = +25^\circ C$.) (Note 1)

PARAMETER	SYMBOL	CONDITIONS	MIN	TYP	MAX	UNITS	
Interchannel Group Delay Distortion Error		$V_{IN} = 1V_{P-P}$; YOUT to PBOUT and YOUT to PROUT	$f = 1MHz$	1		ns	
			$f = 10MHz$	1			
			$f = 30MHz$	1			
Peak Signal to RMS Noise		$100kHz \leq f \leq 30MHz$		62		dB	
Power-Supply Rejection Ratio		$f = 1MHz$, $200mV_{P-P}$	Y channel	40		dB	
			Pb, Pr channels	30			
Output Impedance		$f = 30MHz$		16		Ω	
Crosstalk from Any Active Video Output to Any Quiet Video Output		$f = 30MHz$, video input = $1V_{P-P}$		-65		dB	
STANDARD DEFINITION (MAX9654 Only)							
Standard-Definition Reconstruction Filter		$\pm 1dB$ passband flatness		8.5		MHz	
			$V_{IN} = 1V_{P-P}$, reference frequency is $100kHz$	$f = 5.5MHz$	-0.15		dB
				$f = 9.6MHz$	-3		
				$f = 27MHz$	-57		
2T Pulse-to-Bar K Rating		$2T = 200ns$, bar time is $18\mu s$; the beginning 2.5% and the ending 2.5% of the bar time is ignored		0.15		K%	
2T Pulse Response		$2T = 200ns$		0.2		K%	
2T Bar Response		$2T = 200ns$, bar time is $18\mu s$; the beginning 2.5% and the ending 2.5% of the bar time is ignored		0.15		K%	
Nonlinearity		5-step staircase		0.36		%	
Interchannel Time Error		Difference in time between the 50% point of the output signals; $V_{IN} = 0.5V_{P-P}$, Y to Pb and Y to Pr		1		ns	
Group Delay Distortion		$100kHz \leq f \leq 5.5MHz$		+8.7		ns	
Interchannel Group Delay Distortion Error		$V_{IN} = 1V_{P-P}$; YOUT to PBOUT and YOUT to PROUT	$f = 1MHz$	1		ns	
			$f = 3.58MHz$	1			
			$f = 4.43MHz$	1			
Peak Signal to RMS Noise		$100kHz \leq f \leq 5MHz$		72		dB	
Power-Supply Rejection Ratio		$f = 1MHz$, $200mV_{P-P}$	Y channel	30		dB	
			Pb, Pr channels	25			
Output Impedance		$f = 5MHz$		3		Ω	
Crosstalk from Any Active Video Output to Any Quiet Video Output		$f = 4.43MHz$, video input = $1V_{P-P}$		-75		dB	

Note 1: All devices are 100% production tested at $T_A = +25^\circ C$. Specifications over temperature limits are guaranteed by design.

Note 2: Voltage gain (A_V) is a two-point measurement in which the output voltage swing is divided by the input voltage swing.

3.3V, HD/SD Triple-Channel Filter Amplifiers with Shutdown

Typical Operating Characteristics

($V_{DD} = +3.3V$, video outputs have $R_L = 150\Omega$ connected to GND unless otherwise stated, $V_{SHDN} = V_{DD}$ for MAX9653/MAX9654.)

MAX9652/MAX9653/MAX9654

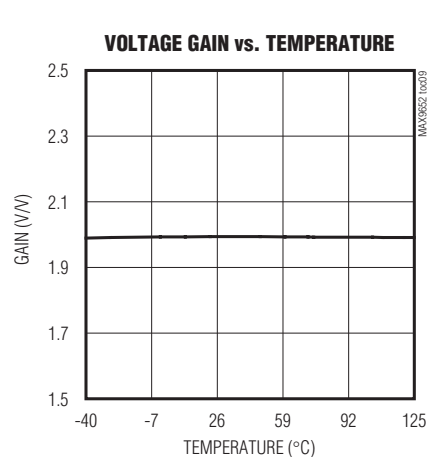
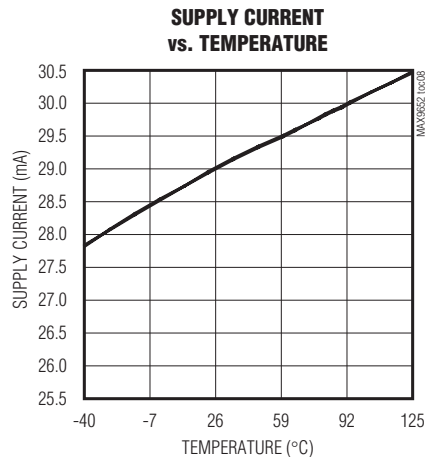
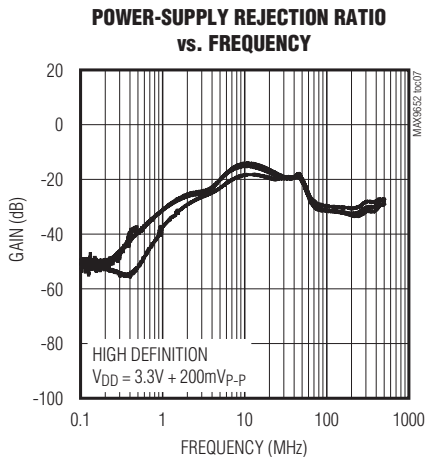
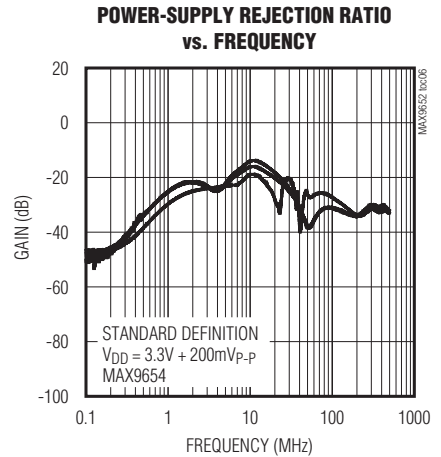
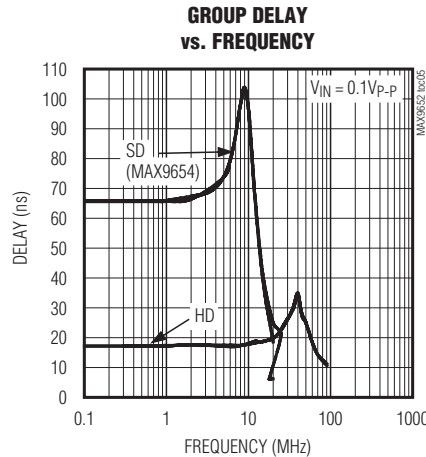
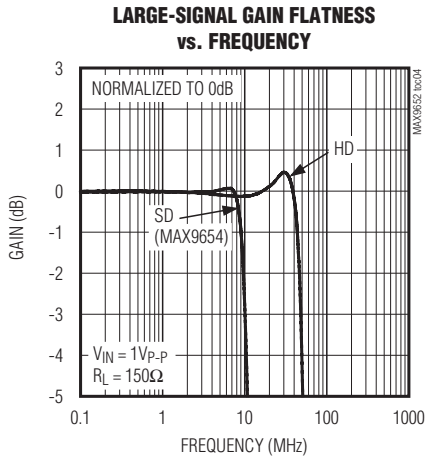
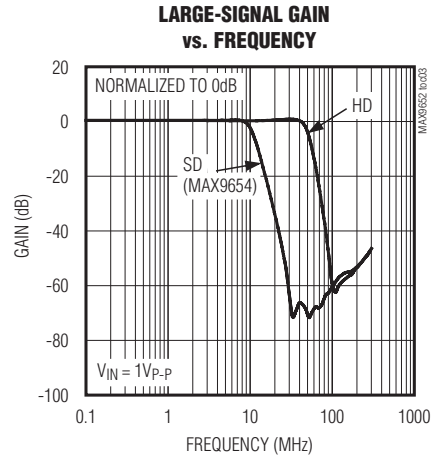
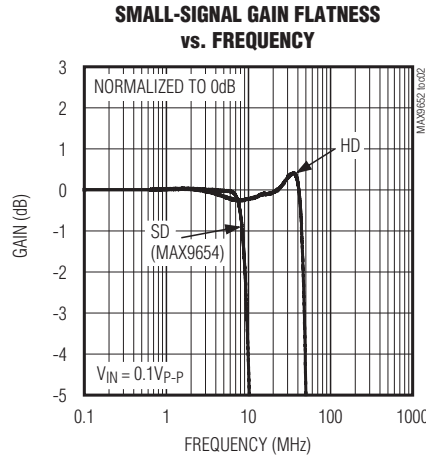
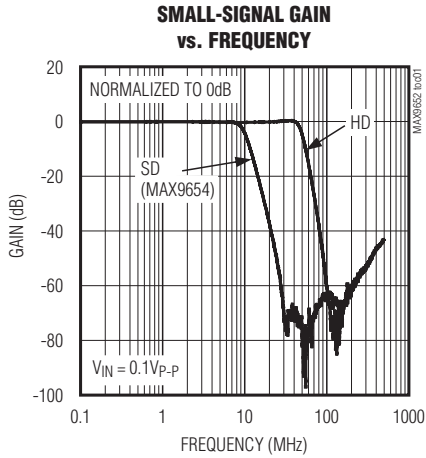

3.3V, HD/SD Triple-Channel Filter Amplifiers with Shutdown

Typical Operating Characteristics (continued)

($V_{DD} = +3.3V$, video outputs have $R_L = 150\Omega$ connected to GND unless otherwise stated, $V_{SHDN} = V_{DD}$ for MAX9653/MAX9654.)

2T PULSE RESPONSE (SD)

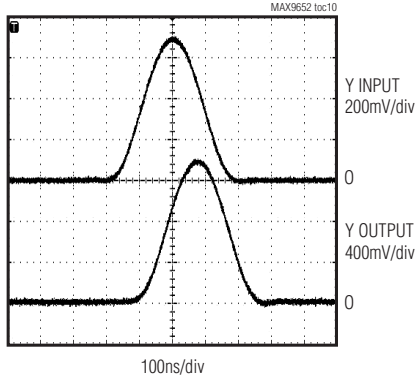

2T PULSE RESPONSE (HD)

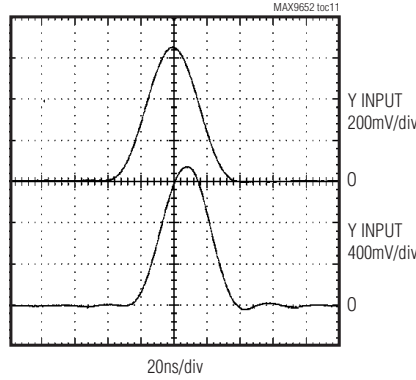

2T BAR RESPONSE (SD)

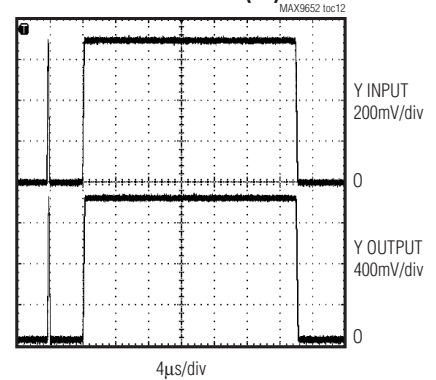

2T BAR RESPONSE (HD)

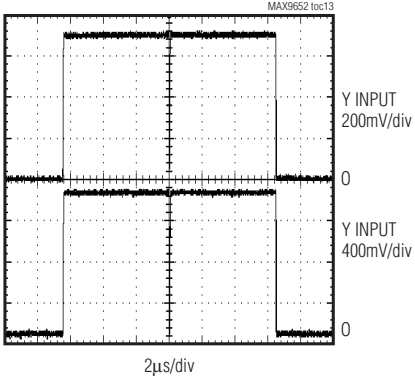

OUTPUT IMPEDANCE vs. FREQUENCY

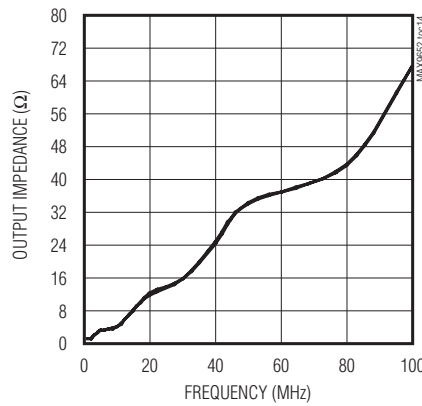

CROSSTALK vs. FREQUENCY

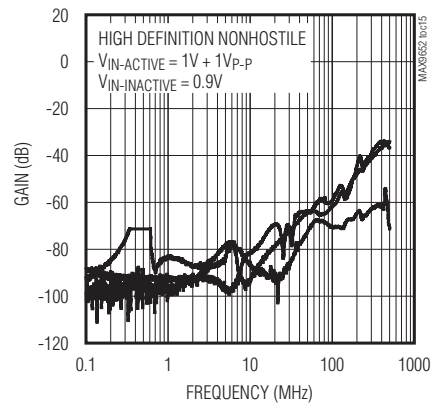

CROSSTALK vs. FREQUENCY

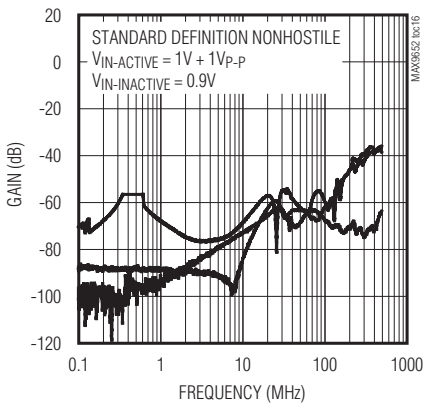

ENABLE TIME Y CHANNEL

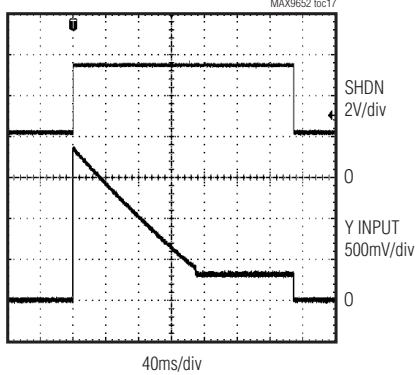

ENABLE TIME Pb CHANNEL

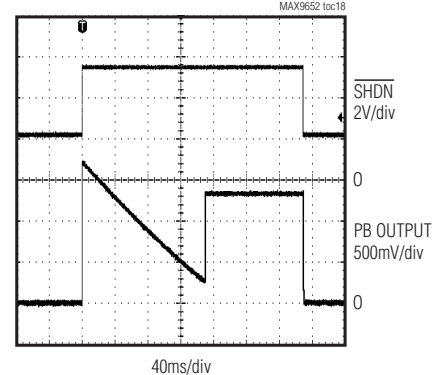

3.3V, HD/SD Triple-Channel Filter Amplifiers with Shutdown

Typical Operating Characteristics (continued)

($V_{DD} = +3.3V$, video outputs have $R_L = 150\Omega$ connected to GND unless otherwise stated, $V_{SHDN} = V_{DD}$ for MAX9653/MAX9654.)

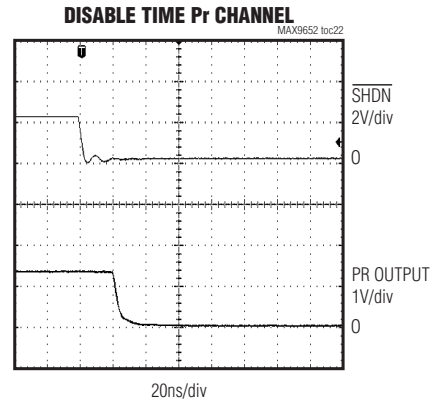
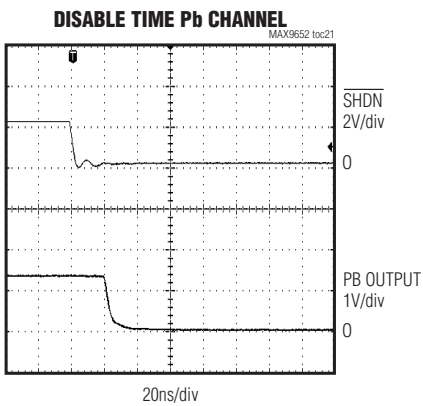
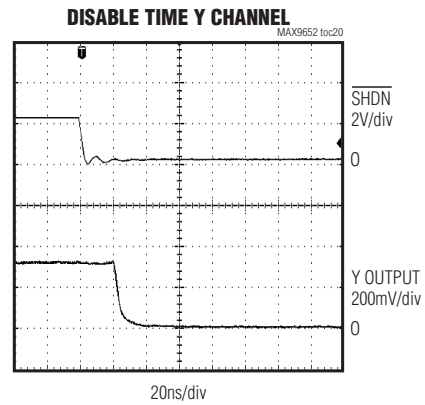
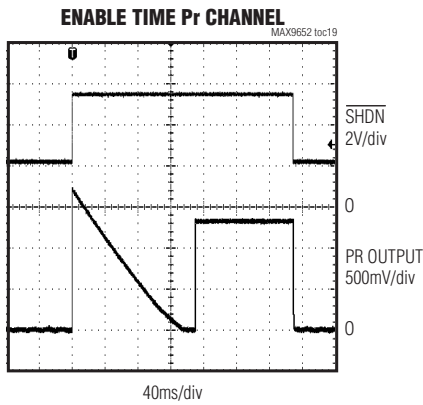

MAX9652/MAX9653/MAX9654

3.3V, HD/SD Triple-Channel Filter Amplifiers with Shutdown

Pin Description

PIN			NAME	FUNCTION
MAX9652	MAX9653	MAX9654		
1	1	1	YIN	Y Input
2	3	3	V _{DD}	Power Supply. Bypass V _{DD} to GND with a 0.1µF capacitor.
3	4	4	PBIN	Pb Input
4	5	5	PRIN	Pr Input
5	6	6	PROUT	Pr Output
6	7	7	PBOUT	Pb Output
7	8, 9	8	GND	Ground
8	10	10	YOUT	Y Output
—	2	2	$\overline{\text{SHDN}}$	Active-Low Shutdown. Connect $\overline{\text{SHDN}}$ to V _{DD} for normal operation and to GND for low power consumption.
—	—	9	SD/ $\overline{\text{HD}}$	Standard-Definition/Active-Low High-Definition Passband Select (MAX9654)

Detailed Description

The MAX9652/MAX9653/MAX9654 are HD video-filter amplifiers that operate from a 3.3V supply. They can be used to lowpass filter the signal after a video digital-to-analog converter (DAC) or before a video analog-to-digital converter (ADC). The inputs to the parts must be AC-coupled; the outputs can be AC- or DC-coupled. The average power consumption of the parts is significantly less than the average power consumption of the 5V generation of HD video filter amplifiers. The quiescent power consumption of the MAX9654 is 95mW, and the average power consumption, which is defined when the parts drive a 150Ω load to ground with color bars, is 200mW.

The MAX9652 is the simplest member of the family, with neither selectable SD/HD filters nor shutdown capability. This device is best suited for line-powered equipment such as set-top boxes, DVD players, and A/V receivers.

The MAX9653 has shutdown capability and is a natural fit in portable equipment and line-powered equipment in which standby power consumption is a concern. The MAX9653 is also an option in SCART set-top boxes with analog high-definition video outputs. In those designs, the same triple DAC typically generates both the standard-definition RGB signals that are routed through the SCART device (refer to the MAX9598 data sheet) and the high-definition YPbPr signals that are routed through the MAX9653. Only one signal set is output at any given time, and so the device connected to the unused outputs must be shut down.

The MAX9654 has both selectable SD/HD filters and shutdown capability. The applications of the MAX9654 are similar to those of the MAX9653, but the MAX9654 provides the additional capability to switch between standard-definition and high-definition formats. The MAX9654 has a passband (±1dB) of 42MHz for high-definition signals and a passband of 8.5MHz for standard-definition signals.

Inputs

Video signals must be AC-coupled into the MAX9652/MAX9653/MAX9654 using 0.1µF capacitors. An input sync tip clamp sets the DC level for the luma signal at YIN. Keyed clamps on PBIN and PRIN set the DC bias of the color difference signals at PBIN and PRIN. When the input sync tip clamp detects a sync pulse on the luma signal, it generates a signal that activates the keyed clamps on PBIN and PRIN.

In shutdown mode, the inputs to the MAX9653 and the MAX9654 do not distort the video signal in case the outputs of the video DAC are also connected to another video circuit such as a dual SCART device. See the *SCART Set-Top Box with Analog HD Outputs* section. The inputs in shutdown mode are biased at V_{DD}/3, which is sufficiently above ground so that the ESD diodes never forward bias as the video signal changes. The input resistance in shutdown is 220kΩ which presents negligible loading on the video current DAC.

HD Video Filter

The MAX9652/MAX9653/MAX9654 have a six-pole, Butterworth filter with a typical passband (±1dB) of

3.3V, HD/SD Triple-Channel Filter Amplifiers with Shutdown

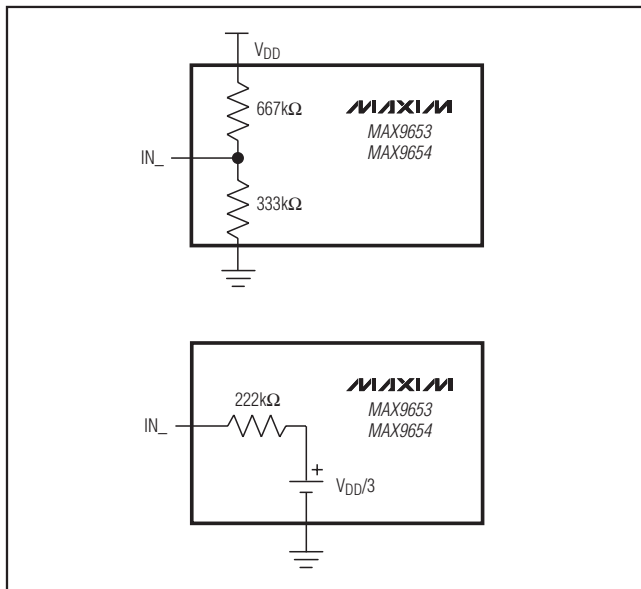

Figure 1. (A) MAX9653/MAX9654 Input Circuit in Shutdown Mode; (B) MAX9653/MAX9654 Equivalent Input Circuit in Shutdown Mode

42MHz, which is well beyond the 30MHz specification for high-definition video signals. The typical attenuation is 30dB at 74.25MHz, which is the sample clock rate for the first generation of high-definition video DACs. The typical attenuation is 50dB at 109MHz, which is also a popular sample clock rate.

SD Video Filter

The MAX9654 has a six-pole Butterworth filter with a typical passband (± 1 dB) of 8.5MHz, which makes the device suitable for standard-definition video signals from all sources (e.g., broadcast and DVD). Broadcast video signals are channel limited: NTSC signals have 4.2MHz bandwidth and PAL signals have 5MHz bandwidth. Video signals from a DVD player, however, are not channel limited, so the bandwidth of DVD video signals can approach the Nyquist limit of 6.75MHz. Recommendation ITU-R BT.601-5 specifies 13.5MHz as the sampling rate for standard-definition video. Therefore, the maximum bandwidth of the signal is 6.75MHz. To ease the filtering requirements, most modern video systems oversample by two times, clocking the video current DAC at 27MHz. The typical attenuation is 57dB at 27MHz.

Video Amplifier

The output amplifiers have a fixed gain of 2V/V, and their rail-to-rail output stages are capable of driving

back-terminated 75Ω loads. The output load can be either DC-coupled or AC-coupled, in which case, use an AC-coupling capacitor of at least 220μF.

The luma signal at YOUT swings between 0.3V and 2.3V approximately. The color difference signals are centered around 1.32V.

Short-Circuit Protection

The back-termination resistor in a typical application limits the short-circuit current if an external short is applied to the system. Additionally, the output amplifiers have built-in short-circuit protection to prevent accidental damage when the outputs are directly shorted to either supply or ground for short times.

Digital Control

The MAX9654 passband is selectable between SD and HD. Pulling SD/HD low results in an HD passband, and pulling SD/HD high results in a SD passband. The MAX9652/MAX9653 have a fixed HD passband.

The MAX9653/MAX9654 feature a shutdown mode. Pull SHDN high for normal operation. Pull SHDN low to put the devices in shutdown, reducing quiescent current to 12μA typically and placing the outputs in high impedance.

Applications Information

Power Consumption

The quiescent power consumption and average power consumption of the MAX9652/MAX9653/MAX9654 are low because of the 3.3V operation. Quiescent power consumption is defined when the parts operate without a load. In this case, the MAX9652/MAX9653/MAX9654 consume approximately 95mW. Average power consumption, which is defined when the MAX9652/MAX9653/MAX9654 drive a 150Ω load to ground with color bars, is about 200mW. Table 1 shows the power consumption with different HD video signals. The supply voltage is 3.3V. The outputs drive 150Ω loads to ground.

Table 1. Power Consumption of the MAX9652/MAX9653/MAX9654 with Different HD Video Signals

VIDEO SIGNAL	POWER CONSUMPTION (mW)
All black screen	181
All white screen	209
Color bars	200

3.3V, HD/SD Triple-Channel Filter Amplifiers with Shutdown

SCART Set-Top Box with Analog HD Outputs

In set-top boxes with SCART connectors and cinch connectors for high-definition YPbPr outputs, a triple video DAC usually outputs either standard-definition RGB signals that are routed to the SCART device or high-definition YPbPr signals that are routed through a high-definition filter amplifier like the MAX9653 (Figure 2). The set-top box devices have a limited number of video DACs, and hence, one bank of triple video DACs switches video format depending upon whether standard-definition RGB or high-definition YPbPr signals are required.

When RGB signals are desired, the high-definition filter amplifier should be turned off so that the RGB signals do not appear on the YPbPr connectors. Similarly, when YPbPr signals are desired, the RGB outputs of the SCART device should be muted or shut down. In either case, the inactive device cannot distort the video signals generated by the DACs.

Power-Supply Bypassing and Ground

The MAX9652/MAX9653/MAX9654 operate from a single-supply voltage of 3.3V, allowing for low-power operation. Bypass V_{DD} to GND with a 0.1 μ F capacitor. Place all external components as close as possible to the device.

Using a Digital Supply

The MAX9652/MAX9653/MAX9654 are designed to operate from noisy digital supplies. The high PSRR (50dB at 100kHz) allows the devices to reject the noise from digital power supplies. If the digital power supply is very noisy and stripes appear on the television screen, increase the supply bypass capacitance. An additional, smaller capacitor in parallel with the main bypass capacitor can reduce digital supply noise because the smaller capacitor has lower equivalent series resistance (ESR) and equivalent series inductance (ESL).

3.3V, HD/SD Triple-Channel Filter Amplifiers with Shutdown

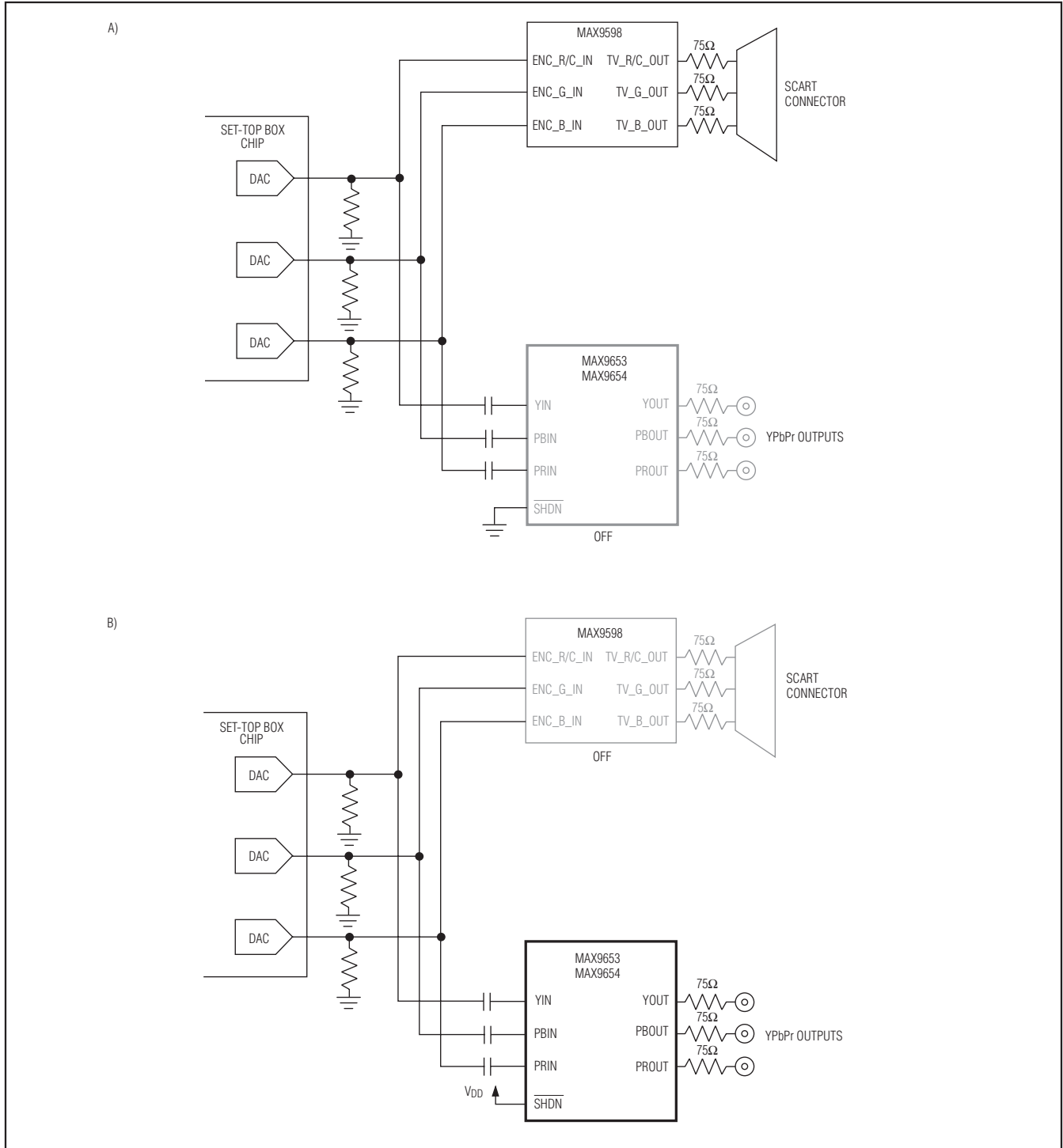
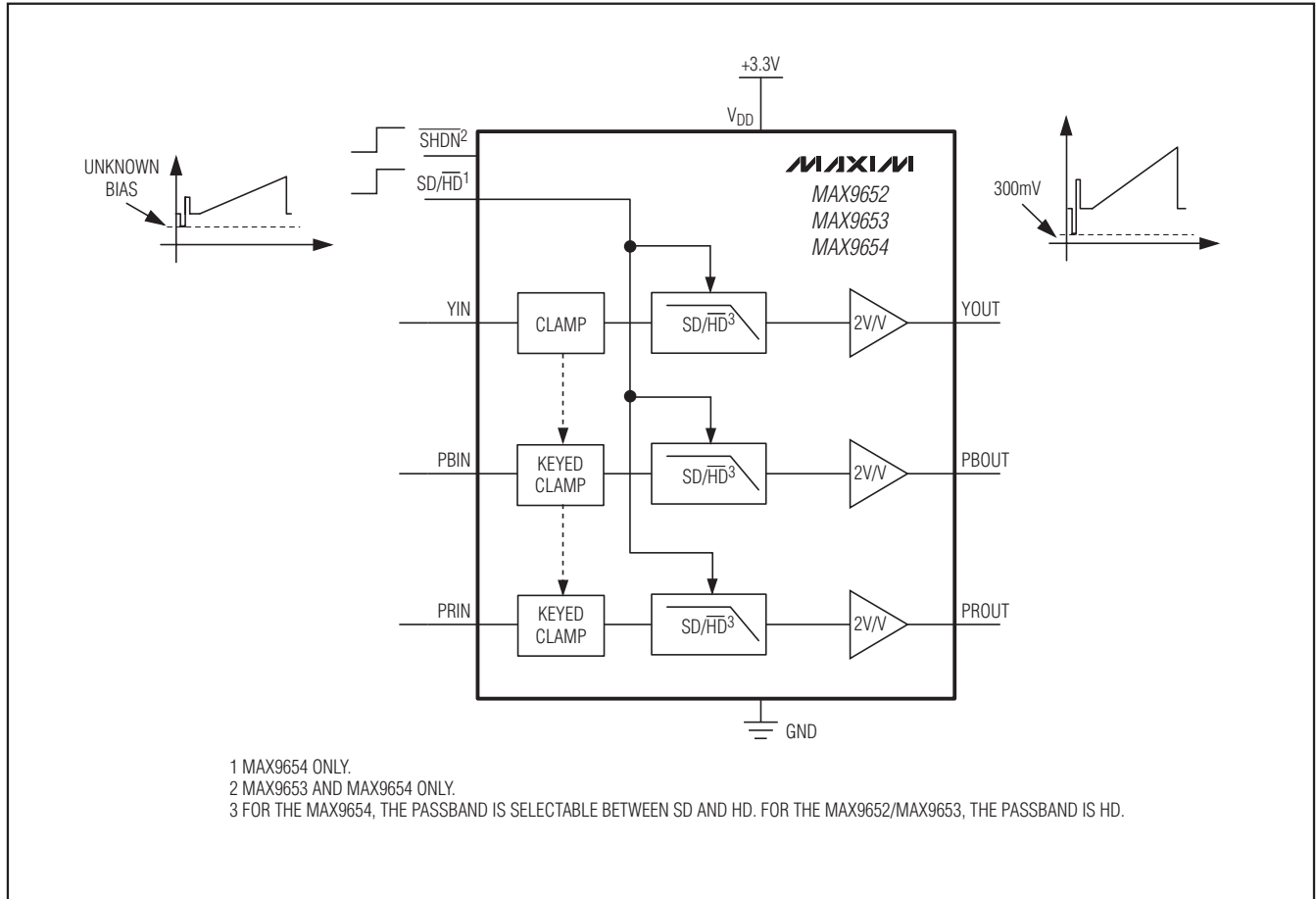

Figure 2. Triple DAC is connected to both a SCART device and a high-definition, video-filter amplifier. (A) SCART device is transmitting standard-definition RGB signals while the HD filter amplifier is in shutdown mode; (B) SCART device is not transmitting RGB signals, but the HD filter amplifier device is transmitting high-definition YPbPr signals.

3.3V, HD/SD Triple-Channel Filter Amplifiers with Shutdown

Block Diagram



3.3V, HD/SD Triple-Channel Filter Amplifiers with Shutdown

Pin Configurations

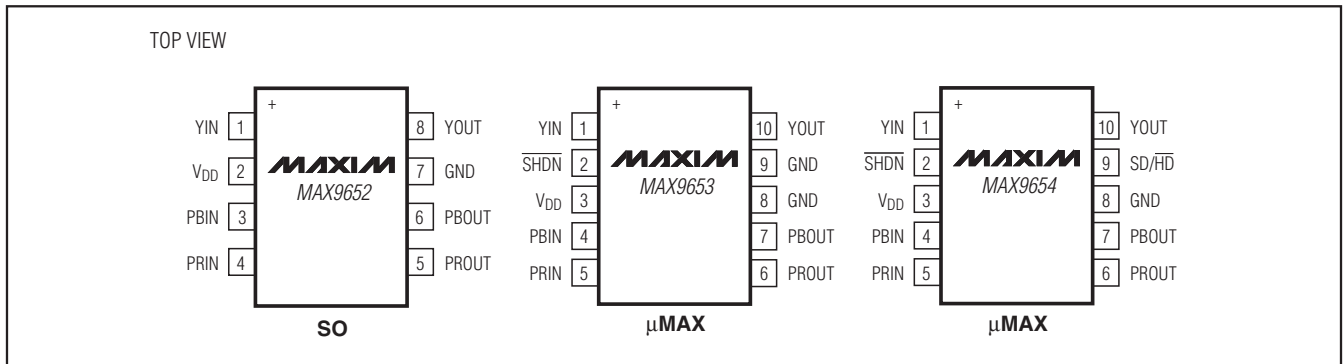

Chip Information

PROCESS: BICMOS

MAX9652/MAX9653/MAX9654

3.3V, HD/SD Triple-Channel Filter Amplifiers with Shutdown

Package Information

(The package drawing(s) in this data sheet may not reflect the most current specifications. For the latest package outline information go to www.maxim-ic.com/packages.)

COMMON DIMENSIONS				
SYMBOL	INCHES		MM	
	MIN.	MAX.	MIN.	MAX.
A	.053	.069	1.35	1.75
A1	.004	.010	0.10	0.25
b	.014	.019	0.35	0.49
c	.007	.010	0.19	0.25
E	.150	.157	3.80	4.00
e	.050	BSC	1.27	BSC
H	.228	.244	5.80	6.20
L	.016	.050	0.40	1.27
α	0°	8°	0°	8°

VARIATION A				
SYMBOL	INCHES		MM	
	MIN.	MAX.	MIN.	MAX.
D	.189	.197	4.80	5.00
N	8			
MS012	AA			
PKG. CODE	S8-2, S8-4, S8-5, S8-6F, S8-7F, S8-8F, S8-10F, S8-11F, S8-16F			

VARIATION B				
SYMBOL	INCHES		MM	
	MIN.	MAX.	MIN.	MAX.
D	.337	.344	8.55	8.75
N	14			
MS012	AB			
PKG. CODE	S14-1, S14-4, S14-5, S14-6; S14M-4, S14M-5, S14M-6, S14M-7			

VARIATION C				
SYMBOL	INCHES		MM	
	MIN.	MAX.	MIN.	MAX.
D	.386	.394	9.80	10.00
N	16			
MS012	AC			
PKG. CODE	S16-1, S16-3, S16-5, S16-6, S16-8, S16-7F, S16-9F, S16-10F; S16M-3, S16M-6			

NOTES:

- ALL DIMENSIONS ARE IN MILLIMETERS UNLESS OTHERWISE SPECIFIED.
- MATERIAL MUST COMPLY WITH BANNED AND RESTRICTED SUBSTANCES SPEC # 10-0131.
- DIMENSIONS D AND E DO NOT INCLUDE MOLD PROTRUSION. ALLOWABLE MOLD PROTRUSION IS 0.15 MM (.006") PER SIDE.
- LEADS TO BE COPLANAR WITHIN 0.10mm (.004").
- MEETS JEDEC MS012
- ALL DIMENSIONS APPLY TO BOTH LEADED (-) AND PbFREE (+) PKG. CODES.

-DRAWING NOT TO SCALE-

TITLE: PACKAGE OUTLINE, 8L, 14L, 16L SOIC .150 INCH

APPROVAL	DOCUMENT CONTROL NO. 21-0041	REV. C	1/1
----------	------------------------------	--------	-----

3.3V, HD/SD Triple-Channel Filter Amplifiers with Shutdown

Package Information (continued)

(The package drawing(s) in this data sheet may not reflect the most current specifications. For the latest package outline information go to www.maxim-ic.com/packages.)

MAX9652/MAX9653/MAX9654

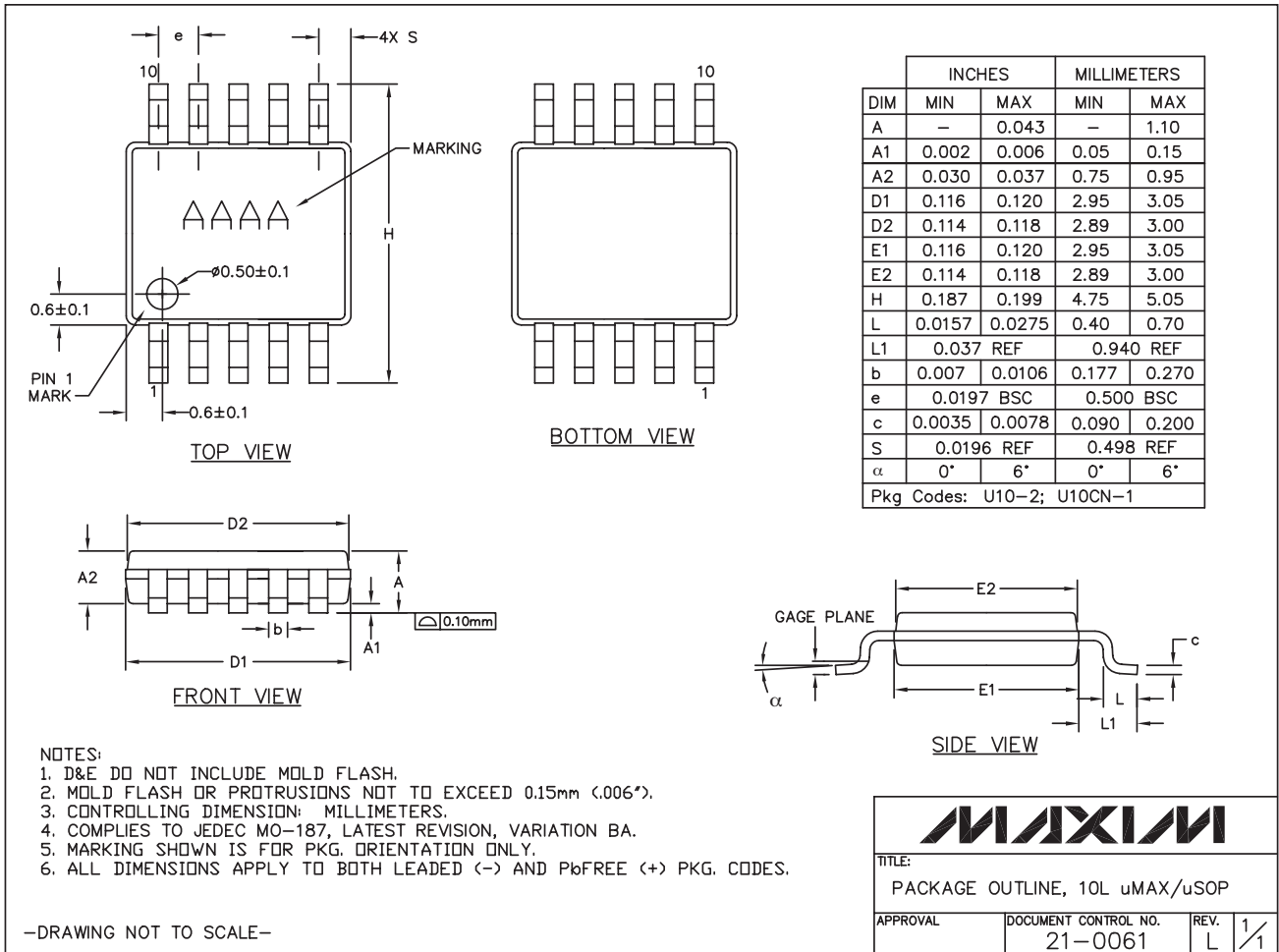

Maxim cannot assume responsibility for use of any circuitry other than circuitry entirely embodied in a Maxim product. No circuit patent licenses are implied. Maxim reserves the right to change the circuitry and specifications without notice at any time.

Maxim Integrated Products, 120 San Gabriel Drive, Sunnyvale, CA 94086 408-737-7600 15