

## ASMB-785

**LGA 1151 Intel® Xeon® E3-1200 v5/  
v6 & 6th/7th Generation Core™  
Series ATX Server Board with  
DDR4, 4 PCIe, 3 PCI, 6 USB 3.0, 6  
COM, 6 SATA3, Quad/Dual LANs**

---

## Copyright

The documentation and the software included with this product are copyrighted 2017 by Advantech Co., Ltd. All rights are reserved. Advantech Co., Ltd. reserves the right to make improvements in the products described in this manual at any time without notice. No part of this manual may be reproduced, copied, translated or transmitted in any form or by any means without the prior written permission of Advantech Co., Ltd. Information provided in this manual is intended to be accurate and reliable. However, Advantech Co., Ltd. assumes no responsibility for its use, nor for any infringements of the rights of third parties, which may result from its use.

## Acknowledgements

AMI is a trademark of American Megatrends Inc.

IBM and PC are trademarks of International Business Machines Corporation.

Intel® Xeon®, Core™ and Pentium® are trademarks of Intel® Corporation.

WinBond is a trademark of Winbond Corporation.

All other product names or trademarks are properties of their respective owners.

## Product Warranty (2 years)

Advantech warrants to you, the original purchaser, that each of its products will be free from defects in materials and workmanship for two years from the date of purchase.

This warranty does not apply to any products which have been repaired or altered by persons other than repair personnel authorized by Advantech, or which have been subject to misuse, abuse, accident or improper installation. Advantech assumes no liability under the terms of this warranty as a consequence of such events.

Because of Advantech's high quality-control standards and rigorous testing, most of our customers never need to use our repair service. If an Advantech product is defective, it will be repaired or replaced at no charge during the warranty period. For out-of-warranty repairs, you will be billed according to the cost of replacement materials, service time and freight. Please consult your dealer for more details.

If you think you have a defective product, follow these steps:

1. Collect all the information about the problem encountered. (For example, CPU speed, Advantech products used, other hardware and software used, etc.) Note anything abnormal and list any onscreen messages you get when the problem occurs.
2. Call your dealer and describe the problem. Please have your manual, product, and any helpful information readily available.
3. If your product is diagnosed as defective, obtain an RMA (return merchandise authorization) number from your dealer. This allows us to process your return more quickly.
4. Carefully pack the defective product, a fully-completed Repair and Replacement Order Card and a photocopy proof of purchase date (such as your sales receipt) in a shippable container. A product returned without proof of the purchase date is not eligible for warranty service.
5. Write the RMA number visibly on the outside of the package and ship it prepaid to your dealer.

Part No. 2001S78501

Printed in China

Edition 2

April 2017

# A Message to the Customer

## Advantech Customer Services

Each and every Advantech product is built to the most exacting specifications to ensure reliable performance in the harsh and demanding conditions typical of industrial environments. Whether your new Advantech equipment is destined for the laboratory or the factory floor, you can be assured that your product will provide the reliability and ease of operation for which the name Advantech has come to be known.

Your satisfaction is our primary concern. Here is a guide to Advantech's customer services. To ensure you get the full benefit of our services, please follow the instructions below carefully.

## Technical Support

We want you to get the maximum performance from your products. So if you run into technical difficulties, we are here to help. For the most frequently asked questions, you can easily find answers in your product documentation. These answers are normally a lot more detailed than the ones we can give over the phone.

So please consult this manual first. If you still cannot find the answer, gather all the information or questions that apply to your problem, and with the product close at hand, call your dealer. Our dealers are well trained and ready to give you the support you need to get the most from your Advantech products. In fact, most problems reported are minor and are easily solved over the phone.

In addition, free technical support is available from Advantech engineers every business day. We are always ready to give advice on application requirements or specific information on the installation and operation of any of our products.

---

# Declaration of Conformity

## FCC

This device complies with the requirements in part 15 of the FCC rules:

Operation is subject to the following two conditions:

- This device may not cause harmful interference
- This device must accept any interference received, including interference that may cause undesired operation.

This equipment has been tested and found to comply with the limits for a Class B digital device, pursuant to Part 15 of the FCC Rules. These limits are designed to provide reasonable protection against harmful interference when the equipment is operated in a commercial environment. This equipment generates, uses, and can radiate radio frequency energy and, if not installed and used in accordance with the instruction manual, may cause harmful interference to radio communications. Operation of this device in a residential area is likely to cause harmful interference in which case the user will be required to correct the interference at his/her own expense. The user is advised that any equipment changes or modifications not expressly approved by the party responsible for compliance would void the compliance to FCC regulations and therefore, the user's authority to operate the equipment.

**Caution!** *There is a danger of a new battery exploding if it is incorrectly installed. Do not attempt to recharge, force open, or heat the battery. Replace the battery only with the same or equivalent type recommended by the manufacturer. Discard used batteries according to the manufacturer's instructions.*



## Peripheral Compatibility

Category	Advantech PN	Vendor	Part Description	Remarks
CPU	TBD	Intel	Xeon E3-1220 v5 / 3.0GHz / 4 Cores	80W (No processor graphics equipped)
	96MPXES-3.3-8M11T	Intel	Xeon E3-1225 v5 / 3.3GHz / 4 Cores	80W
	TBD	Intel	Xeon E3-1230 v5 / 3.3GHz / 4 Cores	80W (No processor graphics equipped)
	TBD	Intel	Xeon E3-1235L v5 / 2.0GHz / 4 Cores	25W
	TBD	Intel	Xeon E3-1240 v5 / 3.5GHz / 4 Cores	80W (No processor graphics equipped)
	TBD	Intel	Xeon E3-1240L v5 / 2.1GHz / 4 Cores	25W (No processor graphics equipped)
	TBD	Intel	Xeon E3-1245 v5 / 3.5GHz / 4 Cores	80W
	TBD	Intel	Xeon E3-1260L v5 / 2.9GHz / 4 Cores	45W (No processor graphics equipped)
	TBD	Intel	Xeon E3-1270 v5 / 3.6GHz / 4 Cores	80W (No processor graphics equipped)
	96MPXES-3.6-8M11T	Intel	Xeon E3-1275 v5 / 3.6GHz / 4 Cores	80W
	96MPI3S-2.7-4M11T	Intel	Core i3-6100TE / 2.7GHz / 2 Cores	35W
	96MPI3S-3.7-3M11T	Intel	Core i3-6100 / 3.7GHz / 2 Cores	47W
	96MPI5S-2.3-6M11T1	Intel	Core i5-6500TE / 2.3GHz / 4 Cores	35W
	96MPI5S-3.2-6M11T	Intel	Core i5-6500 / 3.2GHz / 4 Cores	65W
	96MPI7S-2.4-8M11T1	Intel	Core i7-6700TE / 2.4GHz / 4 Cores	35W
	96MPI7S-3.4-8M11T	Intel	Core i7-6700 / 3.4GHz / 4 Cores	65W
TBD	Intel	Core i7-6700K / 4.2GHz / 4 Cores	91W	
Memory	DDR4 288PIN 1600/1866/2133/2400 ECC/Non-ECC unbuffered DIMM, capacity up to 16GB per DIMM			
Cooler / Heatsink	1960049408N001	CoolJag	LGA 1151 CPU heat-sink for 1U chassis	Support up to 91W processor
	1960052651N021	CoolJag	LGA 1151 CPU cooler for 2U/4U chassis	Support up to 91W processor
Riser Card	AIMB-RF10F-01A1E	Advantech	AIMB-RF10F (1U riser card)	1*PCIe x16 slot
	AIMB-R430P-03A2E	Advantech	AIMB-R430P (2U riser card)	3*PCI slot

AIMB-R43PF-21A1E	Advantech	AIMB-R43PF (2U riser card)	1*PCIe x16 slot
AIMB-RP3P8-12A1E	Advantech	AIMB-R43PF (2U riser card)	2*PCIe x8 slot
ASMB-RF348-21A1E	Advantech	ASMB-RF348 (2U riser card)	1*PCIe x4(slot 1) + 1*PCIe x8(slot3) Slot6 need to be configured as x8x8 link via jumper "JPEG1" and "JPEG2"
ASMB-RF3X8-21A1E	Advantech	ASMB-RF3X8 (2U riser card)	1*PCIe x8(slot 1) + 2*PCI-X(slot2 & 3) Slot6 need to be configured as x8x8 link via jumper "JPEG1" and "JPEG2"
ASMB-RF388-21A1E	Advantech	ASMB-RF388 (2U riser card)	1*PCIe x8 + 2*PClex4 slot Slot6 need to be configured as x8x4x4 via jumper "JPEG1" and "JPEG2"

**Note!**



1. Above list is subject to change. Please contact your sales or FAE for peripheral list.

2. We strongly recommend to purchase all peripheral parts from Advantech to avoid any compatibility issues.

3. Please refer to the table 1.8.1.7 for detail JPEG jumper setting.

### ASMB-785 Ordering Information

Part Number	Chipset	Memory	LAN	Display	IPMI
ASMB-785G4-00A1E	C236	DDR4 288pin ECC/Non-ECC unbuffered DIMM	4	2*DVI + 1*VGA	Optional Module (IPMI-1000-00A2E)
ASMB-785G2-00A1E	C236	DDR4 288pin ECC/Non-ECC unbuffered DIMM	2	2*DVI + 1*VGA	Optional Module (IPMI-1000-00A2E)

## Initial Inspection

Before you begin installing your motherboard, please make sure that the following materials have been shipped:

- 1 ASMB-785 Startup Manual
- 1 Driver CD (user's manual is included)
- 2 Serial ATA HDD data cables (including 1 right angle cable)
- 2 Serial ATA HDD power cables
- 1 I/O port bracket
- 1 Warranty card

If any of these items are missing or damaged, contact your distributor or sales representative immediately. We have carefully inspected the ASMB-785 mechanically and electrically before shipment. It should be free of marks and scratches and in perfect

working order upon receipt. As you unpack the ASMB-785, check it for signs of shipping damage. (For example, damaged box, scratches, dents, etc.) If it is damaged or it fails to meet the specifications, notify our service department or your local sales representative immediately. Also notify the carrier. Retain the shipping carton and packing material for inspection by the carrier. After inspection, we will make arrangements to repair or replace the unit.





# Contents

<b>Chapter 1</b>	<b>Hardware Configuration.....</b>	<b>1</b>
1.1	Introduction .....	2
1.2	Features .....	2
1.3	Specifications .....	3
1.3.1	CPU .....	3
1.3.2	PCH .....	3
1.3.3	Memory .....	3
1.3.4	Input/Output .....	3
1.3.5	Graphics.....	3
1.3.6	Ethernet LAN .....	4
1.3.7	Industrial Features .....	4
1.3.8	Mechanical and Environmental Specifications.....	4
1.4	Jumpers and Connectors .....	4
	Table 1.1: Jumper list .....	4
	Table 1.2: Connector list.....	5
1.5	Board Layout: Jumper and Connector Locations.....	6
	Figure 1.1 Jumper and Connector Locations.....	6
	Figure 1.2 I/O connectors .....	6
1.5.1	Onboard LAN LED Definition .....	7
	Table 1.3: Onboard LAN LED Definition.....	7
1.5.2	Onboard LEDs (LED2, LED3, LED4).....	7
	Table 1.4: Onboard LED (LED2, LED3, LED4) .....	7
1.6	ASMB-785 Block Diagram .....	8
	Figure 1.3 ASMB-785 Block Diagram.....	8
1.7	Safety Precautions .....	9
1.8	Jumper Settings .....	9
1.8.1	How to set jumpers .....	9
	Table 1.5: JCMOS1 .....	10
	Table 1.6: JME1 .....	10
	Table 1.7: Watchdog timer output (JWDT1) .....	10
	Table 1.8: USB power switch (JUSB1/JUSB2).....	11
	Table 1.9: Fan mode selection (CPUFAN_SEL1, SYSFAN_SEL1) 11	
	Table 1.10: ATX/AT mode selector (PSON1) .....	12
	Table 1.11: PCIe link switch (JPEG1) .....	12
	Table 1.12: PEG training (JPEG3) .....	12
	Table 1.13: PCI Clock Selection (JPCICLK1).....	13
1.9	System Memory .....	13
1.10	Memory Installation Procedures.....	13
1.11	PCI Bus Routing Table.....	14
<b>Chapter 2</b>	<b>Connecting Peripherals .....</b>	<b>15</b>
2.1	Introduction .....	16
2.2	USB Ports (LAN1_USB1_2, LAN2_USB5_6, USB3_4, USB7~13) .....	16
2.3	USB Power Switch (JUSB1/JUSB2) .....	17
	Table 2.1: USB power switch (JUSB1/JUSB2).....	17
2.4	VGA and DVI1, DVI2 Connector .....	18
2.5	Serial Ports (COM1 ~ COM6) .....	19
2.6	External Keyboard & Mouse (KBMS1).....	20
2.7	CPU Fan Connector (CPUFAN0).....	21
2.8	System FAN Connector (SYSFAN0 ~ SYSFAN3) .....	22
2.9	Front Panel Connectors (JFP1/2/3) .....	23
2.9.1	Power LED (JFP3 pins 1, 3) .....	24

	Table 2.2: PS/2 or ATX power supply LED status.....	24
2.9.2	External Speaker (JFP2 pins 1, 4, 7, 10).....	24
2.9.3	HDD LED Connector (JFP1 pins 2 & 5).....	24
2.9.4	SNMP SMBus Connector (JFP2 pins 8 & 11) .....	24
2.9.5	ATX Soft Power Switch (JFP1 pins 3 & 6).....	24
2.9.6	Reset Connector (JFP1 pins 9 & 12).....	25
2.10	8-pin Alarm Board Connector (VOLT1).....	25
2.11	Case Open Connector (JCASE1) .....	26
2.12	Front Panel LAN Indicator Connector (LANLED1, LANLED2).....	27
	Table 2.3: Front Panel LAN Indicator Connector (LANLED1) ...	27
	Table 2.4: Front Panel LAN Indicator Connector (LANLED2) ...	27
2.13	Serial ATA Interface (SATA0~5).....	28
2.14	PCI Slots (PCI_SLOT1, PCI_SLOT3, PCI_SLOT5) .....	29
2.15	PCIe x16 Expansion Slot (PCIEX16_SLOT4 and PCIEX16_SLOT6) ....	30
	Table 2.5: PCIX16_SLOT6 Configuration for Riser Card (JPEG1, JPEG2).....	30
2.16	PCIe x4 Expansion Slot (PCIEX4_SLOT2, PCIEX4_SLOT7) .....	31
2.17	Auxiliary 8-pin power connector (ATX12V1).....	32
2.18	SPI Flash Connector(SPI_CN1) .....	33
2.19	Low Pin Count Connector (LPC1).....	33
	Table 2.6: Advantech LPC Module List .....	33
2.20	Parallel Port (LPT1) .....	34
2.21	PCI Clock Selection (JPCICLK1).....	34
	Table 2.7: PCI Clock Selection (JPCICLK1) .....	35

## Chapter 3 BIOS Operation ..... 37

3.1	Introduction .....	38
	Figure 3.1 Main setup screen .....	38
3.2	Entering BIOS Setup.....	39
3.2.1	Main Menu.....	39
	Figure 3.2 Main setup screen .....	39
3.2.2	Advanced BIOS Features Setup.....	40
	Figure 3.3 Advanced BIOS features setup screen .....	40
	Figure 3.4 CPU Configuration .....	41
	Figure 3.5 CPU Power Management Control .....	42
	Figure 3.6 Intel ME FW Configuration Information .....	43
	Figure 3.7 ASF Support.....	44
	Figure 3.8 Activate Remote Assistance Process.....	44
	Figure 3.9 PET Progress .....	45
	Figure 3.10 OEM Flags Settings .....	45
	Figure 3.11 MEBx Resolution Settings.....	46
	Figure 3.12 ME FW Image Re-Flash.....	46
	Figure 3.13 TPM Settings.....	47
	Figure 3.14 ACPI Settings .....	48
	Figure 3.15 SMART Setting.....	49
	Figure 3.16 COM1/COM2/LPT Configuration.....	49
	Figure 3.17 COM1 Configuration.....	50
	Figure 3.18 COM2 Configuration.....	50
	Figure 3.19 Parallel Port Configuration .....	51
	Figure 3.20 PC Health Status.....	52
	Figure 3.21 COM3/4/5/6 Configuration.....	53
	Figure 3.22 COM3 Configuration.....	53
	Figure 3.23 COM4 Configuration.....	54
	Figure 3.24 COM5 Configuration.....	54
	Figure 3.25 COM6 Configuration.....	55
	Figure 3.26 PCA-COM232 Configuration .....	56
	Figure 3.27 Serial Port 1 Configuration .....	57
	Figure 3.28 S5 RTC Wake Settings .....	58

	Figure 3.29Serial Port Console Redirection .....	59
	Figure 3.30Legacy Console Redirection Settings.....	60
	Figure 3.31PCI subsystem settings screen .....	61
	Figure 3.32CSM Configuration .....	62
	Figure 3.33USB Configuration.....	63
3.2.3	Chipset.....	64
	Figure 3.34Chipset .....	64
	Figure 3.35System Agent (SA) Configuration.....	64
	Figure 3.36Graphics Configuration.....	65
	Figure 3.37DMI Configuration.....	66
	Figure 3.38NB PCIe Configuration .....	66
	Figure 3.39PEG Port Feature Configuration.....	67
	Figure 3.40Memory Configuration .....	68
	Figure 3.41PCH-IO Configuration.....	69
	Figure 3.42PCI Express Configuration .....	70
	Figure 3.43PCI Express Slot 2 Configuration .....	71
	Figure 3.44PCI Express Slot 7 Configuration .....	72
	Figure 3.45SATA Configuration.....	73
	Figure 3.46USB Configuration.....	74
3.2.4	Security .....	75
	Figure 3.47Security.....	75
3.2.5	Boot.....	76
	Figure 3.48Boot .....	76
3.2.6	Save & Exit .....	77
	Figure 3.49Save & Exit.....	77

## **Chapter 4    Chipset Software Installation Utility 79**

4.1	Before You Begin .....	80
4.2	Introduction .....	80
4.3	Windows OS Driver Setup .....	80

## **Chapter 5    VGA Setup.....83**

5.1	Introduction .....	84
5.2	Windows OS Driver Setup .....	84

## **Chapter 6    LAN Configuration.....85**

6.1	Introduction .....	86
6.2	Features .....	86
6.3	Installation .....	86
6.4	Windows OS Driver Setup (LAN) .....	86

## **Chapter 7    Intel ME.....87**

7.1	Introduction .....	88
7.2	Installation .....	88

## **Chapter 8    Intel USB 3.0.....89**

8.1	Introduction .....	90
8.2	Installation .....	90

## **Chapter 9    SATA RAID Setup.....91**

9.1	Introduction .....	92
9.2	SATA RAID Driver and Utility Setup .....	92

## **Chapter 10 HD Audio..... 93**

10.1	Introduction .....	94
10.2	Installation.....	94

## **Appendix A Programming the Watchdog Timer . 95**

A.1	Watchdog timer overview.....	96
A.2	Programming the Watchdog Timer .....	96
	Table A.1: Watchdog timer registers .....	98
A.2.1	Example Programs .....	98

## **Appendix B I/O Pin Assignments ..... 103**

B.1	USB2.0 Header (USB7~12) .....	104
	Table B.1: USB Header (USB6~11) .....	104
B.2	USB3.0 Header (USB3_4) .....	104
	Table B.2: USB 3.0 Header (USB3_4) .....	104
B.3	VGA Connector (VGA).....	105
	Table B.3: VGA Connector (VGA) .....	105
B.4	RS-232 Interface (COM2) .....	105
	Table B.4: RS-232 Interface (COM2) .....	105
B.5	External Keyboard and Mouse Connector (KBMS1) .....	106
	Table B.5: External Keyboard and Mouse Connector (KBMS1)....	106
B.6	System Fan Power Connector (SYSFAN0~3) .....	106
	Table B.6: Fan Power Connector .....	106
B.7	Power LED and Keyboard Lock (JFP3) .....	106
	Table B.7: Power LED and Keyboard Lock (JFP3) .....	106
B.8	External Speaker Connector (JFP2) .....	107
	Table B.8: External Speaker Connector (JFP2) .....	107
B.9	HDD LED Connector (JFP2).....	107
	Table B.9: HDD LED Connector (JFP2) .....	107
B.10	SNMP SMBus Connector (JFP2).....	107
	Table B.10:SNMP SMBus Connector (JFP2) .....	107
B.11	ATX Soft Power Switch (JFP1) .....	108
	Table B.11:ATX Soft Power Switch (JFP1) .....	108
B.12	Reset Connector (JFP1) .....	108
	Table B.12:Reset Connector (JFP1).....	108
B.13	USB/LAN ports (LAN1_USB1_2 and LAN2_USB5_6) .....	108
	Table B.13:USB Port .....	108
	Table B.14:Giga LAN 10/100/1000 Mbps RJ-45 port .....	108
B.14	Front Panel Audio Connector (FPAUD1) .....	109
	Table B.15:Front Panel Audio Connector (FPAUD1) .....	109
B.15	8-pin Alarm Board Connector (VOLT1).....	109
	Table B.16:8-pin Alarm Board Connector (VOLT1) .....	109
B.16	Case Open Connector (JCASE1) .....	110
	Table B.17:Case Open Connector (JCASE1).....	110
B.17	Front Panel LAN LED Connector (LAN_LED1,LAN_LED2) .....	110
	Table B.18:LAN LED Connector (LANLED1) .....	110
	Table B.19:LAN LED Connector (LANLED2) .....	110
B.18	SPI_CN1: SPI Flash Card Pin Connector .....	110
	Table B.20:SPI_CN1:SPI Flash Card Pin Connector .....	110
B.19	GPIO Connector (GPIO1) .....	111
	Table B.21:GPIO Connector (GPIO1) .....	111

B.20	SMBUS1: Connector of SMBUS from PCH .....	111
	Table B.22:SMBUS Connector .....	111
B.21	System I/O Ports .....	111
	Table B.23:System I/O ports .....	111
B.22	Interrupt Assignments .....	112
	Table B.24:Interrupt assignments .....	112
B.23	1st MB Memory Map .....	112
	Table B.25:1st MB memory map .....	112
B.24	Parallel Port (LPT1).....	113
	Table B.26:Parallel Port (LPT1) .....	113



# Chapter 1

Hardware  
Configuration

## 1.1 Introduction

ASMB-785 motherboard is designed with the most advanced Intel® C236 PCH for industrial server grade applications that require high-performance computing. The motherboard supports Intel® Xeon® E3 v5/v6 & 6th/7th Generation Core™ processors with DDR4 288pin 1600/1866/2133/2400 MHz ECC/Non-ECC memory for up to 64 GB. ASMB-785 also provides cost-effective Intel HD graphics integrated on processor, and the graphics VRAM has 1 GB maximum of shared memory with 2 GB and above of system memory installed.

To fulfill various demands from the video surveillance and factory automation markets, ASMB-785 offers maximum up to four Gen3 PCIe slots, including one PCIe x16 slot with x16 link, or switchable to two PCIe x16 slots with x8 link from CPU, and two PCIe x4 slots from PCH. In addition, ASMB-785 also comes with three PCI slots via a discrete PCIe to PCI bridge chip to support legacy PCI expansion cards and has four or two Gigabit Ethernet LAN via dedicated PCIe bus, which offers bandwidth up to 300 MB/s.

By using the Intel® C236 chipset, ASMB-785 offers a variety of features such as seven onboard SATA III interfaces (bandwidth = 600 MB/s) with software RAID; 6 x USB 3.0 and 7 x USB 2.0 connectors. These powerful I/O capabilities ensure reliable data storage capabilities and high-speed I/O peripheral connectivity.

The ASMB-785 also adopts Advantech's unique, patented Sleep Mode Control Circuit for AT Power Mode. With all these excellent features and outstanding performance, ASMB-785 is the ideal platform for today's industrial applications.

## 1.2 Features

- **Triple Display:** ASMB-785 has one VGA and two DVI-D ports. Users are able to use all display outputs to implement triple display functions.
- **PCIe architecture:** There is one PCIe x16 slot (x16 link) or two PCIe x16 slots (x8 link) from the Intel CPU, and two x4 slots (x4 link) from the Intel C236 PCH.
- **High Performance I/O capability:** 4 or 2 x Gigabit LAN via PCIe bus, 3 x PCI 32-bit/33 or 66 MHz PCI slots, 6 x USB 3.0, 7 x USB 2.0 ports (1\*Type A USB 2.0), 6 x SATA III connectors.
- **Standard ATX form factor with industrial features:** ASMB-785 provides industrial features like long product life, reliable operation under wide temperature range, watchdog timer functions, etc.
- **Automatic power on after power failure:** It is often necessary to have an unattended system come back into operation when power resumes after a power failure. Advantech's industrial motherboard allows users to set the system to power on automatically without anyone hitting power button. Please refer to the detailed "AT" mode settings in Table 1.10 of Section 1.8.1.6.
- **Active Management Technology 9.0:** The hardware and firmware base solution is powered by the system auxiliary power plane to remotely monitor networked systems. Intel AMT (iAMT) stores hardware and software information in non-volatile memory. Built-in management provides out-of-band management capabilities, allowing remote discovery and KVM to repair systems after OS failures or when a system has crashed. Alert and event logging features detect problems and quickly reduce downtime, pro-actively blocking incoming threats, containing infected clients before they impact the network, and proactively notifying the user when critical software agents are removed. To enable iAMT, please refer to Section 3.2.2.4 AMT Configuration.



## 1.3 Specifications

### 1.3.1 CPU

- Supports one E3-1200 v5/v6 Series and 6th/7th Gen. Core i3, i5 & i7 CPU in an LGA1151 socket.
- Max. TPD can support up to 91 W.

### 1.3.2 PCH

- **System Chipset:** Intel® C236
- **SATA hard disk drive interface:** Six on-board SATA III connectors support Advanced Host Controller Interface (AHCI) technology, Intel Rapid Storage Technology (IRST) for software RAID 1, 0, 10 and 5 support, and have data transmission rates up to 600 MB/s.

### 1.3.3 Memory

- **RAM:** Up to 64 GB in four 288-pin DIMM sockets. Supports dual-channel DDR4 ECC/Non-ECC 1600/1866/2133/2400 unbuffered U-DIMM.

**Note!**  1. Due to the inherent limitations of PC architecture, the system may not fully detect 64 GB RAM when 64 GB RAM is installed.  
2. A 32-bit OS may not fully detect 4 GB of RAM when 4 GB is installed.

### 1.3.4 Input/Output

- **PCIe slot (Gen3):** 1 PCIe x16 expansion slot with x16 link or switchable to 2 PCIe x16 expansion slots with x8 link, or 2 PCIe x4 expansion slots with x4 links.
- **PCI slot:** 3 PCI slot, 32-bit, 33 or 66 MHz PCI 2.2 compliant, and clock could be selected by jumper(JPCICLK1).
- **Enhanced parallel port:** Configured to LPT1 or disabled. Standard DB-25 female connector cable is an optional accessory. LPT1 supports EPP/SPP/ECP.
- **Serial port:** Six serial ports (1 in rear and 5 onboard), only supports RS-232.
- **PS/2 Keyboard and mouse connector:** To save rear I/O space, ASMB-785 reserves a 6-pin header on board (KBMS1) and via a cable kit to build two 6-pin mini-DIN connectors for easy connection to PS/2 keyboard and mouse.
- **USB port:** Supports up to 6 USB 3.0 ports with transmission up to 5Gbps and 7 USB 2.0 ports with transmission rates up to 480 Mbps.
- **LPC:** One LPC connector supports Advantech TPM LPC modules and COM 232/485 modules. (Slot-2 & 3 can't be used when COM module is installed.)
- **GPIO:** ASMB-785 supports 8-bit GPIO from super I/O for general purpose control application.

### 1.3.5 Graphics

- **Graphics processor:** Integrated Intel HD Graphics.
- **Display memory:** 1 GB maximum shared memory with 2 GB and above system memory installed
- **DVI-D:** Two DVI-D ports up to resolution 1920 x 1200 @ 60 Hz refresh rate
- **D-Sub:** Up to 1920 x 1200 resolution @ 60 Hz refresh rate

### 1.3.6 Ethernet LAN

- **Interface:** Supports four 10/100/1000 Mbps Ethernet port (s) via PCIe bus which provides a 300 MB/s data transmission rate.
- **Controller:** LAN1: Intel I219-LM; LAN2 ~ 4: Intel I210-AT (LAN3/4 is for G4 SKU only).

### 1.3.7 Industrial Features

- **Watchdog timer:** It can generate system reset or NC. The watchdog timer is programmable, with each unit equal to one second (255 levels).
- **IPMI:** Supports IPMI 2.0 via optional IPMI-1000 module

### 1.3.8 Mechanical and Environmental Specifications

- **Operating temperature:** 0 ~ 60° C (32 ~ 140° F, Depending on CPU)
- **Storage temperature:** -40 ~ 85° C (-40 ~ 185° F)
- **Humidity:** 5 ~ 95% non-condensing
- **Power supply voltage:** +3.3 V, +5 V, ±12 V, 5 VSB
- **Power consumption:**  
Max. load: +3.3 V @ 0.96 A, +5 V @ 1.58 A, +12 V @ 0.32 A, +12 V (8P) @ 7.21 A, +5 Vsb @ 0.11 A, -12 V @ 0.06 A
- **Board size:** 304.8 x 244 mm (12" x 9.6")
- **Board weight:** 0.75 kg (1.68 lb)

## 1.4 Jumpers and Connectors

Connectors on the ASMB-785 motherboard link it to external devices such as hard disk drives and a keyboard. In addition, the board has a number of jumpers that are used to configure your system for your application.

The tables below list the function of each of the jumpers and connectors. Later sections in this chapter give instructions on setting jumpers. Chapter 2 gives instructions for connecting external devices to your motherboard.

**Table 1.1: Jumper list**

Label	Function
JCMOS1	CMOS clear
JME1	Intel ME disable jumper for ME/BIOS update
JWDT1	Watch Dog Reset
CPUFAN_SEL1, SYSFAN_SEL1	FAN PWM(1-2)/DC mode selection(2-3)
PSON1	AT(1-2) / ATX(2-3)
JCASE1	Case open
JPEG1, JPEG2	PCIEX16_SLOT6 PCIe link switch between one x16 or two x8, or x8 plus two x4
JPEG3	Default (1-2)/reserve for debug (2-3)
JTHR_SEL1	To select on board or external thermometer
JGREEN1	Enable/Disable deep sleep mode
JUSB1	Rear window USB2.0/3.0 port power source switch between +5 VSB and +5 V
JUSB2	On board USB2.0/3.0 port power source switch between +5 VSB and +5 V
JPCICLK1	PCI slot clock selection between 33 and 66 MHz

**Table 1.1: Jumper list**

JSKTOCC1	To force power when no CPU installed, normal (1-2)/ debug (2-3)
----------	---

**Table 1.2: Connector list**

Label	Function
ATXPWR1	ATX 24 Pin main power connector (for system)
ATX12V1	Processor power connector (for CPU)
SATA0~6	SATA III (6 Gb/s)
USB7_8, USB9_10, USB11_12	USB 2.0 Port (Header)
USB13	USB 2.0 Port (USB Type A)
USB3_4	USB 3.0 Port (Header)
PCI_SLOT1, PCI_SLOT3, PCI_SLOT5	PCI slot
PCIEX4_SLOT2, PCIEX4_SLOT7	PCIe x4 slot (Gen3 x4 link)
PCIEX16_SLOT4, PCIEX16_SLOT6	PCIe x16 slots (one Gen3 x16 link for slot 6 or two Gen3 x8 link)
DIMMA0, DIMMA1, DIMMB0, DIMMB1	DDR4 288-pin slot
CPUFAN0	CPU FAN connector
SYSFAN0, SYSFAN1, SYSFAN2, SYSFAN3	System FAN connector
LAN1_USB1_2, LAN2_USB5_6	LAN1 / USB 3.0 port 1, 2 stack connector LAN2 / USB 3.0 port 5, 6 stack connector
LAN3_4	LAN3 & LAN4 connector
VGA1_COM1	VGA+COM connector
DVI1_DVI2	DVI-D connector
KBMS1	External keyboard and mouse connector (6 pin)
SPI_CN1	SPI flash card pin header
LANLED1~2	LAN LED extension connector
SMBUS1	SM Bus From PCH
GPIO1	8-bit GPIO header
FPAUD1	Audio front panel header
COM2, COM3_4, COM5_6	Serial port: RS-232
LPC1	Low pin count connector for Advantech TPM LPC and RS232/422/485 modules.
VOLT1	Voltage display
AUDIO1	Audio connector
BH2	For optional battery kit
EX_THR1	For thermometer kit
SGPIO1, SGPIO2	Serial General Purpose I/O
JFP1	Power Switch / Reset connector
JFP2	External speaker/HDD LED connector/SMBus connector
JFP3	Keyboard Lock and Power LED
SPDIF_OUT1	SPDIF audio output pin header
BMC1	BMC connector to support IPMI-1000 module
PMBUS1	PMBUS connector to communicate with power supply

# 1.5 Board Layout: Jumper and Connector Locations

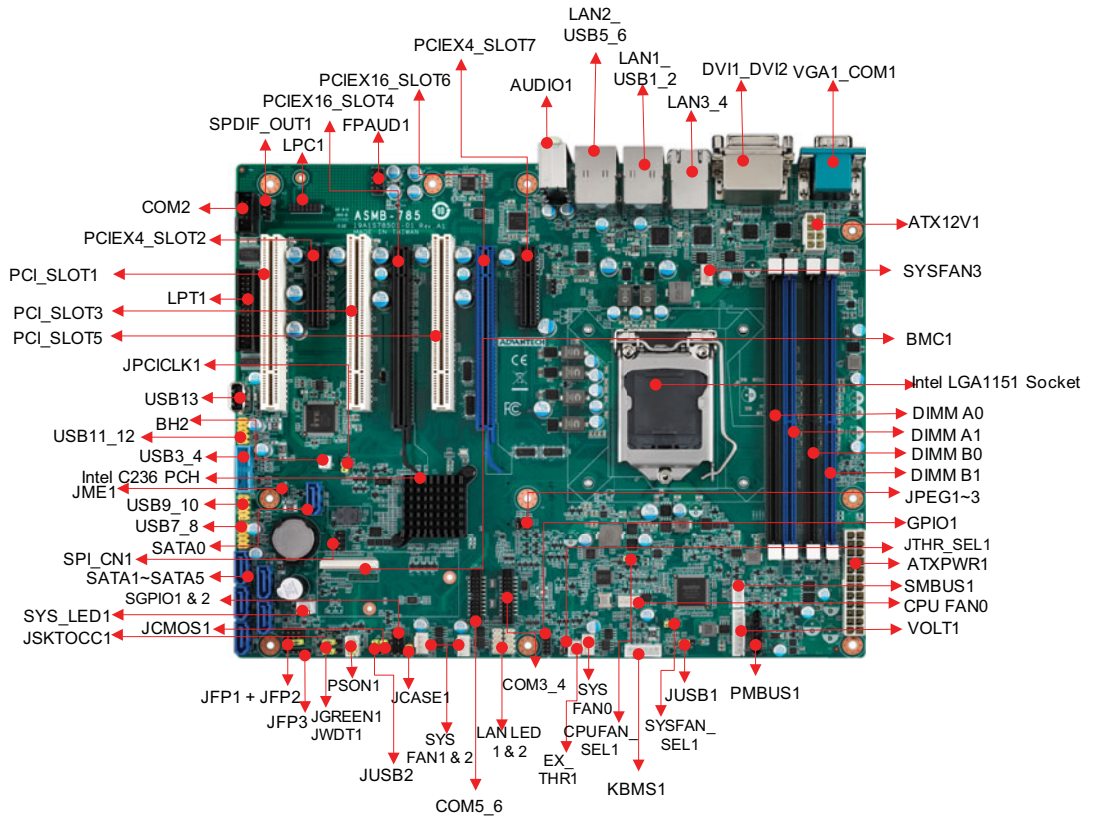

Figure 1.1 Jumper and Connector Locations

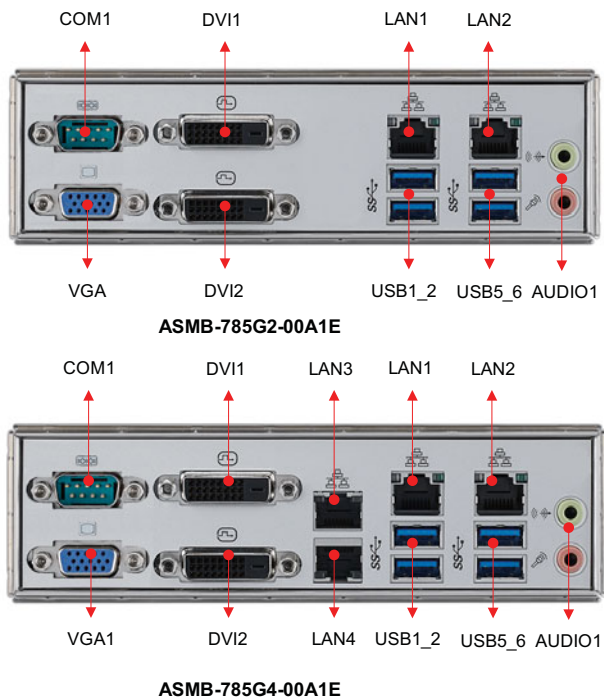
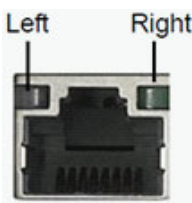

Figure 1.2 I/O connectors

## 1.5.1 Onboard LAN LED Definition

**Table 1.3: Onboard LAN LED Definition**

10/100/1000 Mbps LAN Link/Activity LED Scheme			
		LAN1 ~ LAN4	
		Left LED	Right LED
10 Mbps	Link Active	Off Off	Green Blinking green
100 Mbps	Link Active	Amber Amber	Green Blinking green
1000 Mbps	Link Active	Green Green	Green Blinking green
No Link		Off	Off

## 1.5.2 Onboard LEDs (LED2, LED3, LED4)

The ASMB-785 has onboard power LED for 5V Power, 5V Standby and 3.3V AUX.

**Table 1.4: Onboard LED (LED2, LED3, LED4)**

LED	Description	LED Definition	
5V_LED2	Power on LED	Off: Power off	On (Green): System is On
5VSB_LED3	Standby LED	Off: No input AC Power	On (Green): System is ON, in sleep mode, or in soft-off mode
3V3DSW_LED4	Deep sleep well LED	Off: No input AC Power, Deep sleep mode enable	On (Green): System is ON, in sleep mode, in soft-off mode, or deep sleep mode disable

## 1.6 ASMB-785 Block Diagram

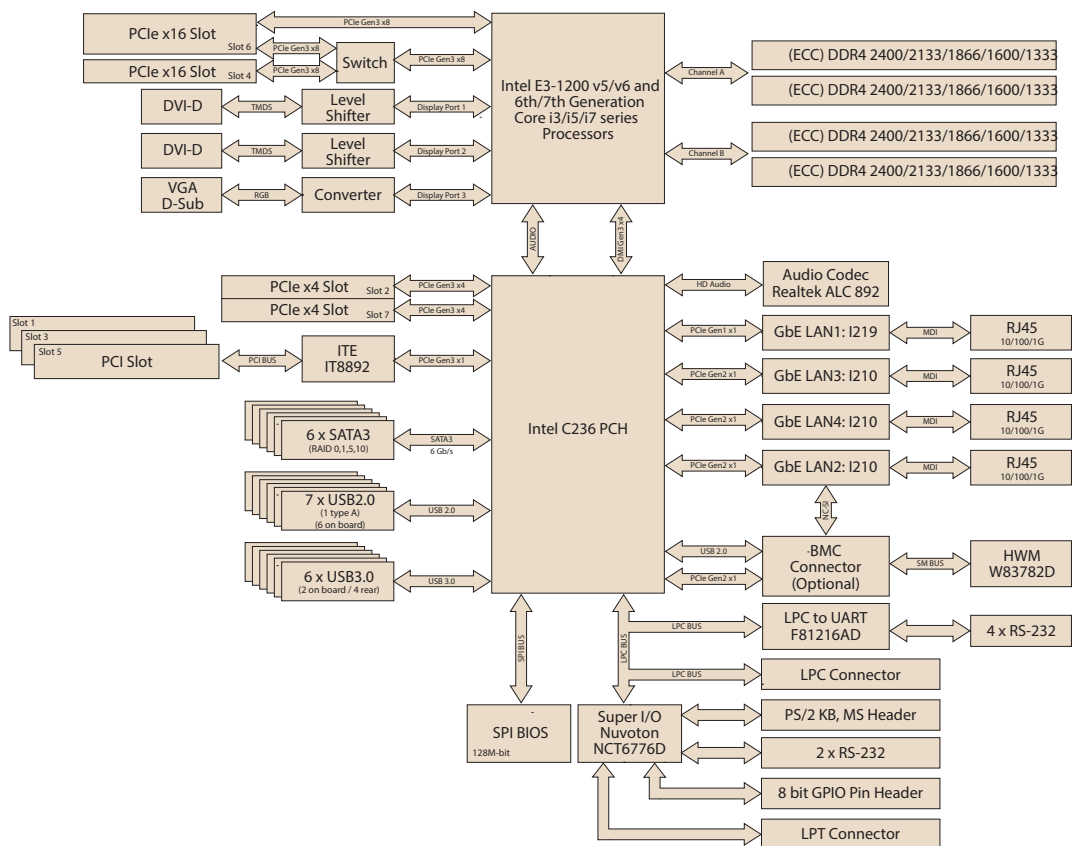

Figure 1.3 ASMB-785 Block Diagram

## 1.7 Safety Precautions

**Warning!** *Always completely disconnect the power cord from your chassis whenever you work with the hardware. Do not make connections while the power is on. Sensitive electronic components can be damaged by sudden power surges. Only experienced electronics personnel should open the PC chassis.*



**Caution!** *Always ground yourself to remove any static charge before touching the motherboard. Modern electronic devices are very sensitive to static electric discharges. As a safety precaution, use a grounding wrist strap at all times. Place all electronic components on a static-dissipative surface or in a static-shielded bag when they are not in the chassis.*



**Caution!** *The computer is provided with a battery-powered real-time clock circuit. There is a danger of explosion if battery is incorrectly replaced. Replace only with same or equivalent type recommended by the manufacturer. Discard used batteries according to manufacturer's instructions.*



**Caution!** *There is a danger of a new battery exploding if it is incorrectly installed. Do not attempt to recharge, force open, or heat the battery. Replace the battery only with the same or equivalent type recommended by the manufacturer. Discard used batteries according to the manufacturer's instructions.*



## 1.8 Jumper Settings

This section provides instructions on how to configure your motherboard by setting the jumpers. It also includes the motherboard default settings and your options for each jumper.

### 1.8.1 How to set jumpers

You can configure your motherboard to match the needs of your application by setting the jumpers. A jumper is a metal bridge that closes an electrical circuit. It consists of two metal pins and a small metal clip (often protected by a plastic cover) that slides over the pins to connect them. To “close” (or turn on) a jumper, you connect the pins with the clip. To “open” (or turn off) a jumper, you remove the clip. Sometimes a jumper consists of a set of three pins, labeled 1, 2, and 3. In this case you connect either pins 1 and 2, or 2 and 3. A pair of needle-nose pliers may be useful when setting jumpers.

#### 1.8.1.1 CMOS and ME clear (JCMOS1)

The ASMB-785 motherboard contains a jumper that can erase CMOS data and reset the system BIOS information. Normally this jumper should be set with pins 1-2 closed. If you want to reset the CMOS data, set JCMOS1 to 2-3 closed for just a few seconds, and then move the jumper back to 1-2 closed. This procedure will reset the CMOS to its default setting.

**Table 1.5: JCMOS1**

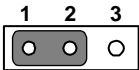
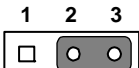
Function	Jumper Setting
* Keep CMOS data	 1-2 closed
Clear CMOS data	 2-3 closed
* default setting	

**1.8.1.2 ME update (JME1)**

The ASMB-785 contains a jumper that can update for ME firmware. Normally this jumper should be set with pin 1-2 closed. If you want to update ME firmware, set JME1 to 2-3 closed to disable ME for new ME firmware update.

**Table 1.6: JME1**

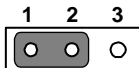
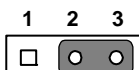
Function	Jumper Setting
*Lock ME update	 1-2 closed
ME update	 2-3 closed
* default setting	

**1.8.1.3 Watchdog timer output (JWDT1)**

The ASMB-785 contains a watchdog timer that will reset the CPU. This feature means the ASMB-785 will recover from a software failure or an EMI problem. The JWDT1 jumper settings control the outcome of what the computer will do in the event the watchdog timer is tripped.

**Table 1.7: Watchdog timer output (JWDT1)**

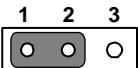
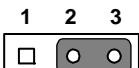
Function	Jumper Setting
*Reset	 1-2 closed
NC	 2-3 closed
* default setting	



**Note!** *The interrupt output of the watchdog timer is a low level signal. It will be held low until the watchdog timer is reset.*



#### 1.8.1.4 USB power switch (JUSB1/JUSB2)

The ASMB-785 contains a jumper that can support on board USB ports power source from +5Vsb or +5V. The JUSB1 jumper controls the USB2.0 and 3.0 ports of rear window. The JUSB2 jumper controls the USB2.0 and 3.0 ports of onboard header and connectors. The default setting is 1-2 closed which supports USB stand-by power under S5. When the jumper is 2-3 closed, the on board USB ports power source will be switched to +5V if you want to disable USB stand-by power under S5, and under 2-3 closed, which won't support S3 and S4 modes.

**Table 1.8: USB power switch (JUSB1/JUSB2)**

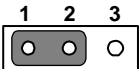
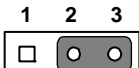
Function	Jumper Setting
*+5Vsb	 1-2 closed
+5V	 2-3 closed
* default setting	

#### 1.8.1.5 CPU,SYSTEM fan PWM/DC mode selection(CPUFAN\_SEL1, SYSFAN\_SEL1)

The ASMB-785 contains a jumper that can support PWM or DC mode. Normally this jumper should be set with pin 1-2 closed. If you want to change to DC mode, set CPUFAN\_SEL1, SYSFAN\_SEL1 to 2-3 closed for disable.

**Table 1.9: Fan mode selection (CPUFAN\_SEL1, SYSFAN\_SEL1)**

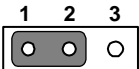
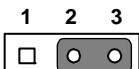
Function	Jumper Setting
*PWM mode	 1-2 closed
DC mode	 2-3 closed
* default setting	

### 1.8.1.6 ATX/AT mode selector (PSON1)

The ASMB-785 contains a jumper that can support ATX or AT mode. Normally this jumper should be set with pin 2-3 closed. If you want to change to AT mode, set PSON to 1-2 closed.

**Table 1.10: ATX/AT mode selector (PSON1)**

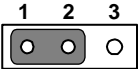
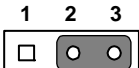
Function	Jumper Setting
AT Mode	 1-2 closed
* ATX Mode	 2-3 closed
* default setting	

### 1.8.1.7 PCIe link switch (JPEG1, JPEG2)

The ASMB-785 contains a jumper that can switch one PCIe x16 link on PCIEX16\_SLOT6 to two x8 link on PCIEX16\_SLOT6 & SLOT4. Default setting with pin 1-2 closed is one x16 on PCIEX16\_SLOT6 (PCIEX16\_SLOT4 can't work). If you want to use PCIEX16\_SLOT4 with x8 link, set JPEG1 to 2-3 closed and keep JPEG2 pin 1-2 closed for enable. Jumper setting for riser card support please refer to Section 2.15 PCIe x16 Expansion Slot.

**Table 1.11: PCIe link switch (JPEG1)**

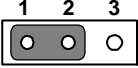
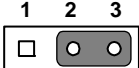
Function	Jumper Setting
* One x16 link	 1-2 closed
Two x8 link	 2-3 closed
* default setting	

### 1.8.1.8 PEG training (JPEG3)

The ASMB-785 contains a jumper that can support PEG training with pin 1-2 closed as default setting.

**Table 1.12: PEG training (JPEG3)**

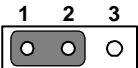
Function	Jumper Setting
* PEG training	 1-2 closed
* default setting	

### 1.8.1.9 PCI Clock Selection (JPCICLK1)

JPCICLK1 is a jumper to select PCI slot clock between 66 or 33 MHz, and the default setting is 33 MHz (2-3 closed).

**Table 1.13: PCI Clock Selection (JPCICLK1)**

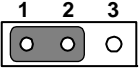
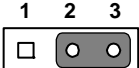
Function	Jumper Setting
PCI Clock at 66 MHz	 1-2 closed
*PCI Clock at 33 MHz	 2-3 closed
* default setting	

## 1.9 System Memory

ASMB-785 has four 288-pin memory sockets for DDR4 unbuffered ECC/Non-ECC 1600/1866/2133/2400 MHz memory modules with maximum capacity of 64 GB (Maximum 16 GB for each DIMM).

**Note!** ASMB-785 does NOT support registered DIMMs (RDIMMs).



## 1.10 Memory Installation Procedures

To install DIMMs, first make sure the two handles of the DIMM socket are in the “open” position. i.e. The handles lean outward. Slowly slide the DIMM module along the plastic guides on both ends of the socket, and then press the DIMM module right down into the socket, until you hear a click. This is when the two handles have automatically locked the memory module into the correct position of the DIMM socket. To remove the memory module, just push both handles outward, and the memory module will be ejected by the mechanism in the socket.

	Quantity of memory module installed		
	1	2	4
Socket / Color			
DIMM A0 (Black)			V
DIMM A1 (Blue)	V	V	V
DIMM B0 (Black)			V
DIMM B1 (Blue)		V	V

---

## 1.11 PCI Bus Routing Table

AD PCI slot INT	PCI_SLOT1	PCI_SLOT3	PCI_SLOT5
	AD16	AD17	AD18
A	A	B	C
B	B	C	D
C	C	D	A
D	D	A	B

# Chapter 2

Connecting  
Peripherals

## 2.1 Introduction

You can access most of the connectors from the top of the board as it is being installed in the chassis. If you have a number of cards installed, you may need to partially remove a card to make all the connections.

## 2.2 USB Ports (LAN1\_USB1\_2, LAN2\_USB5\_6, USB3\_4, USB7~13)

ASMB-785 provides up to 13 USB ports. USB7~13 are USB 2.0 ports supporting transmission rates up to 480 Mbps, and USB1~6 are USB 3.0 ports supporting transmission rates up to 5Gbps. These ports support Plug & Play and hot swapping for up to 127 external devices, which are able to be disabled in the BIOS menu.

The ASMB-785 is equipped with two (G2 sku) or four (G4 sku) high-performance 1000 Mbps Ethernet LANs. They are supported by all major network operating systems. The RJ-45 jacks on the rear plate provide convenient 1000 Mbps operation.

If all USB ports will be used, USB power is recommended to switch to +5V instead of +5VSB.

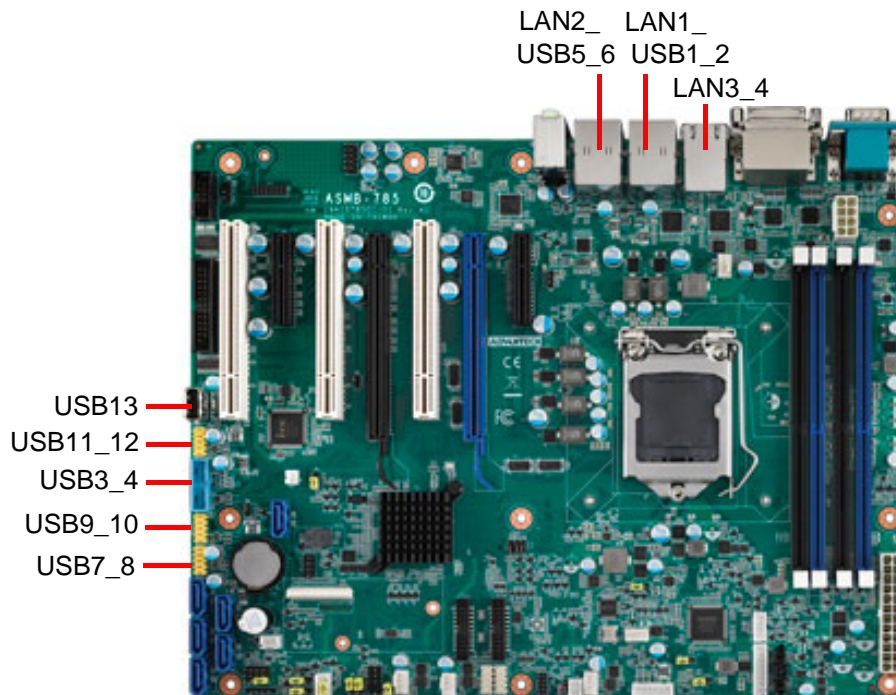

## 2.3 USB Power Switch (JUSB1/JUSB2)

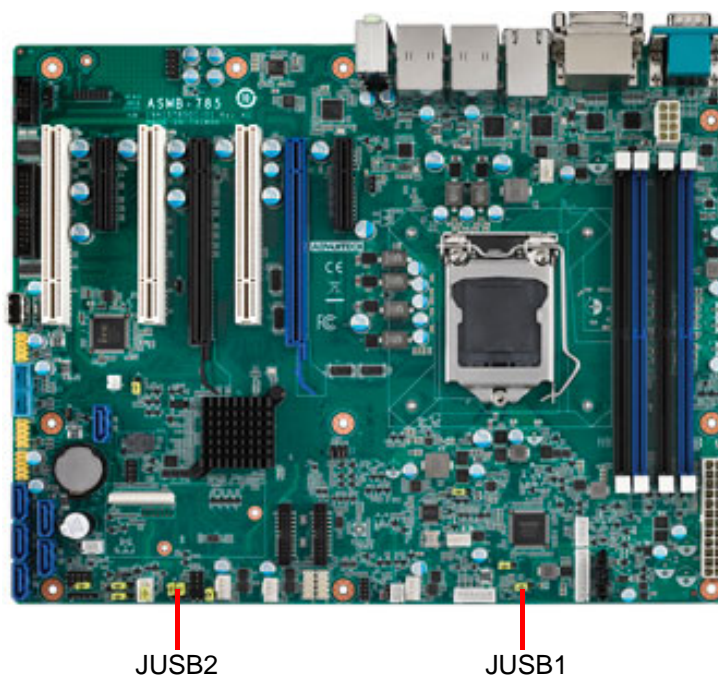

ASMB-785 allows user to set USB power between +5Vsb and +5V.  
When the jumper is set as +5V, the board doesn't support S3/S4.

Jumper	USB Ports
JUSB1	Rear Window: USB1_2, USB3_4, USB5_6
JUSB2	On board: USB7_8, USB9_10, USB11_12, USB13

**Note!** When USB power is switched to +5V, it can't be connected with powered KVM.

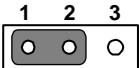
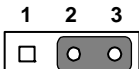
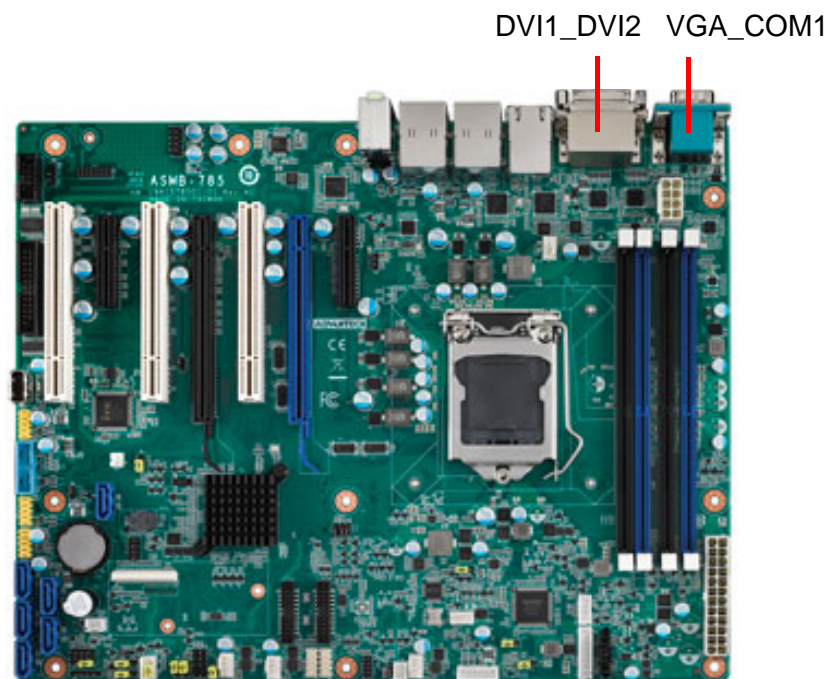

**Table 2.1: USB power switch (JUSB1/JUSB2)**

Function	Jumper Setting
*+5Vsb	 1-2 closed
+5V	 2-3 closed

\* default setting

## 2.4 VGA and DVI1, DVI2 Connector



The ASMB-785 includes one VGA and two DVI-D connectors, users could display all ports at the same time (The result may different because of OS support limitations).



## 2.5 Serial Ports (COM1 ~ COM6)

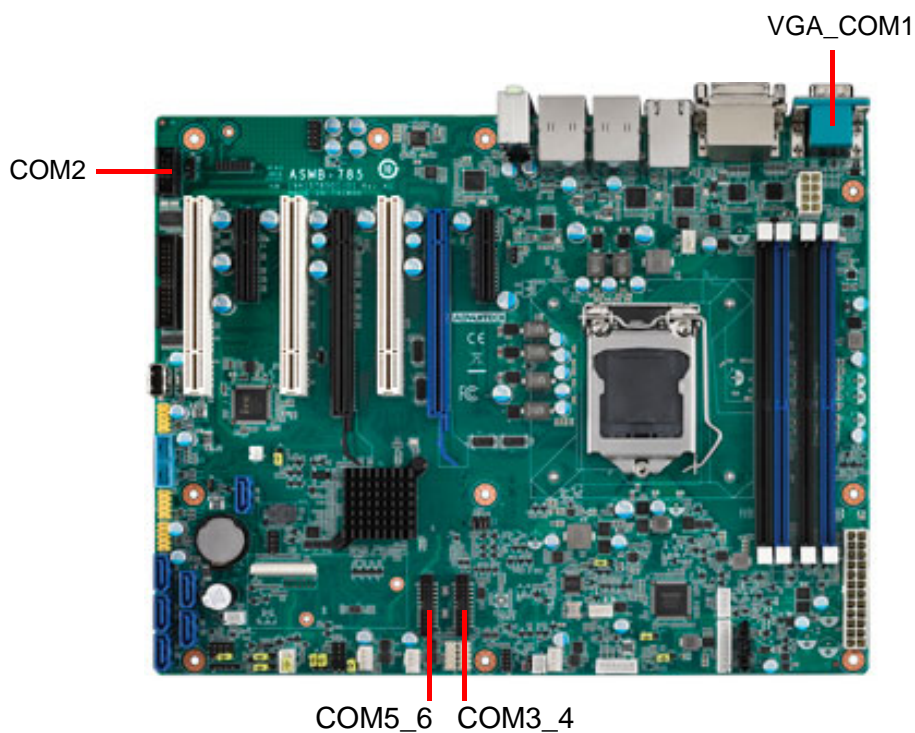

The ASMB-785 offers six serial ports (one on the rear panel and five onboard). All ports can connect to a serial mouse, printer or communications network.

The IRQ and address ranges for those ports are fixed. However, if you want to disable the port or change these parameters later, you can do this in the system BIOS setup. Different devices implement the RS-232 standards in different ways.

## 2.6 External Keyboard & Mouse (KBMS1)

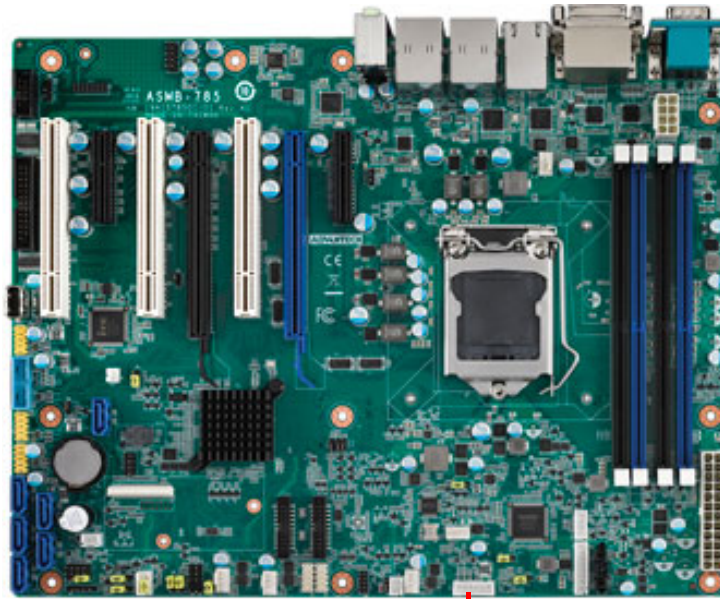

KBMS1

There is an onboard external keyboard and mouse connector on the motherboard. That gives system integrators greater flexibility in designing their systems.

## 2.7 CPU Fan Connector (CPUFAN0)

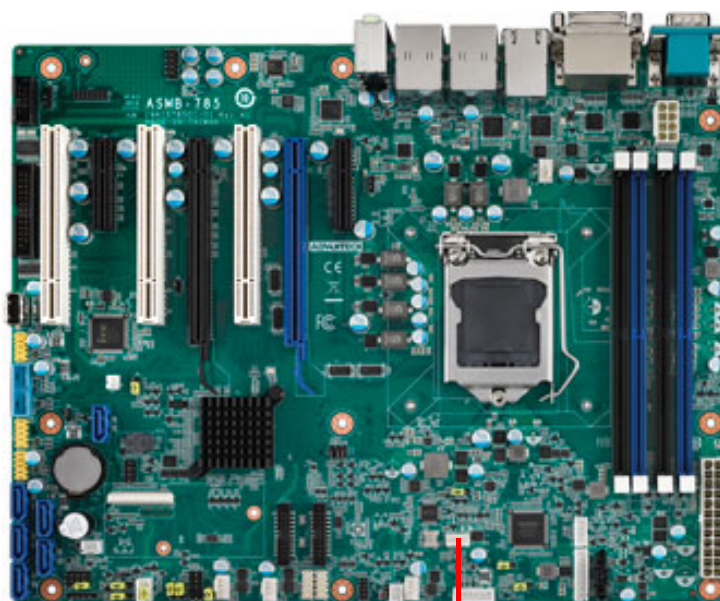

CPUFAN0

If a fan is used, this connector supports cooling fans that draw up to 2.5 A (30 W).

## 2.8 System FAN Connector (SYSFAN0 ~ SYSFAN3)

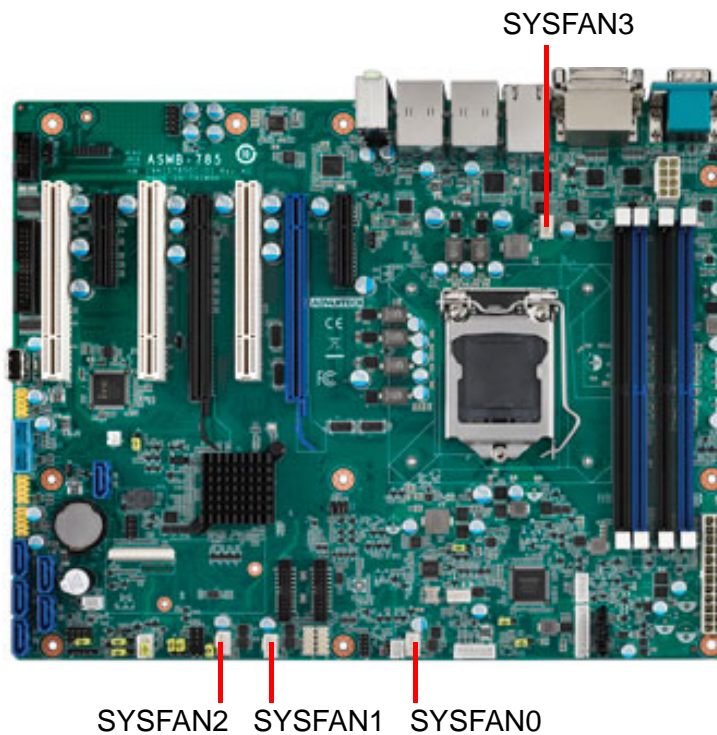

If a fan is used, this connector supports cooling fans that draw up to 2.5 A (30 W).

## 2.9 Front Panel Connectors (JFP1/2/3)

There are several external switches and LEDs to monitor and control the ASMB-785.

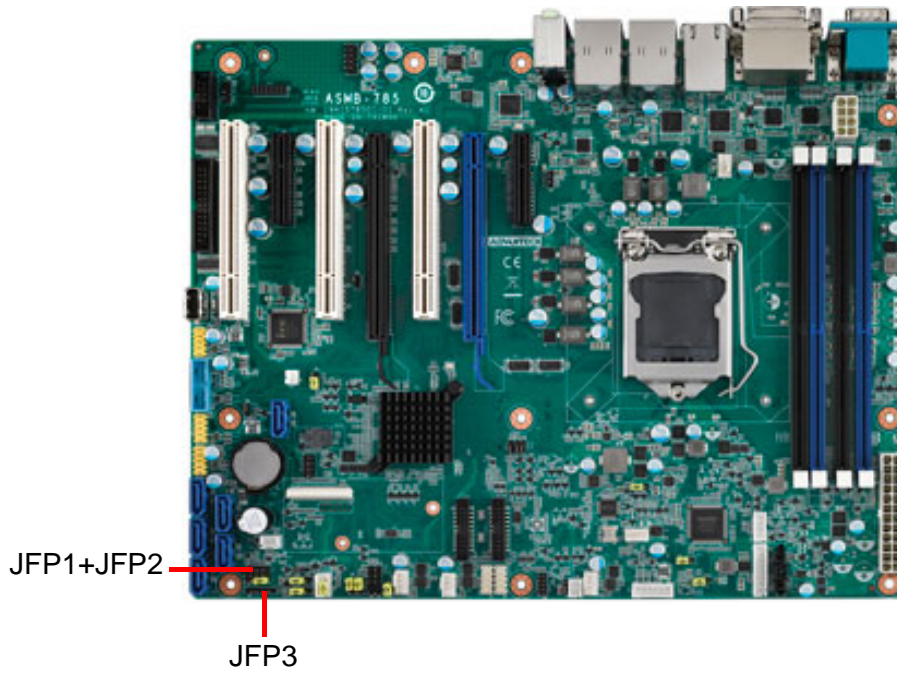

JFP1	3	6	9	12	PWRSW	RESET
&	2	5	8	11	HDDLED	SNMP SM_BUS
JFP2	1	4	7	10	SPEAKER	
JFP3	1	2	3	4	PWRLD & KEYLOCK	

## 2.9.1 Power LED (JFP3 pins 1, 3)

JFP3 is a 5-pin connector for the power LED. Refer to Appendix B for detailed information on the pin assignments. If a ATX power supply is used, the system's power LED status will be as indicated as follows.

**Table 2.2: PS/2 or ATX power supply LED status**

Power mode	LED
System On	On
System Suspend	Fast Flash
System Off	Off
System Off in deep sleep	Off

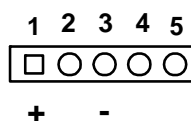

## 2.9.2 External Speaker (JFP2 pins 1, 4, 7, 10)

JFP2 pins 1, 4, 7, 10 connector for an external speaker. The ASMB-785 provides an onboard buzzer as an alternative. To enable the onboard buzzer, set pins 7-10 as closed.

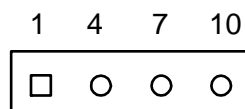

## 2.9.3 HDD LED Connector (JFP1 pins 2 & 5)

You can connect an LED to connector JFP1 to indicate when the HDD is active.

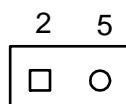

## 2.9.4 SNMP SMBus Connector (JFP2 pins 8 & 11)

ASMB-785 supports Advantech module for providing a platform independent system management. When you're installing module on ASMB-785, please connect it to pins 8 and 11 of JFP2. (Pin 8 is data pin, pin 11 is clock pin)

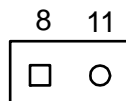

## 2.9.5 ATX Soft Power Switch (JFP1 pins 3 & 6)

If your computer case is equipped with an ATX power supply, you should connect the power on/off button on your computer case to pins 3 and 6 of JFP1. This connection enables you to turn your computer on and off.

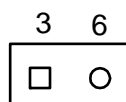

### 2.9.6 Reset Connector (JFP1 pins 9 & 12)

Many computer cases offer the convenience of a reset button.

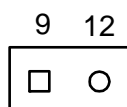

### 2.10 8-pin Alarm Board Connector (VOLT1)

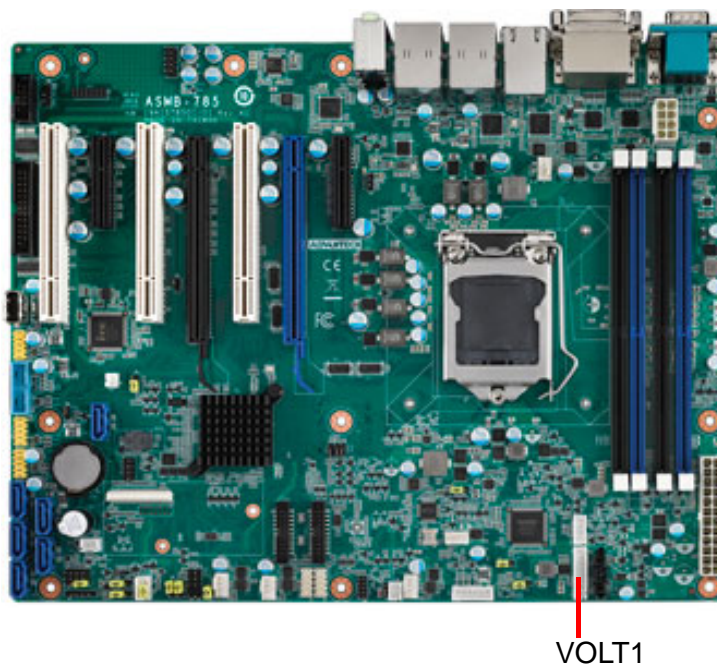

VOLT1 connects to the alarm board of Advantech chassis. These alarm boards monitors the input voltage of +12V, +5V, +5Vsb, -5V +3.3V and -12V, and give warnings if a power supply fails.

## 2.11 Case Open Connector (JCASE1)

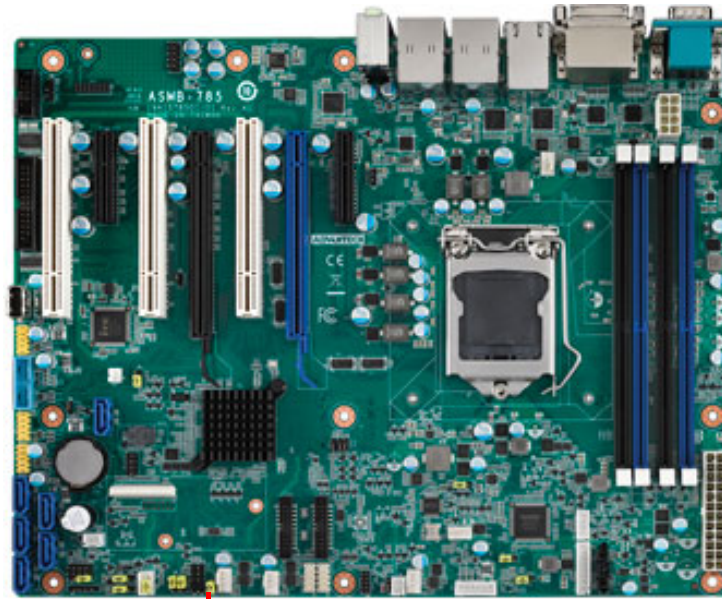

JCASE1

JCASE1 is for chassis with a case open sensor. The default setting of JCASE1 is shorted by jumper and disabled in the BIOS. Before using, please remove the jumper and attach the appropriate cable from the chassis. Then, change the BIOS setting to enable the case open function. Please refer to Chapter 3 BIOS Operation, section 3.2.2.6 HW Monitor. If the chassis is opened, the BIOS will inform you with a warning message of a chassis intrusion during system reboot and post screen.



## 2.12 Front Panel LAN Indicator Connector (LANLED1, LANLED2)

LANLED1 is extension connector of LAN1 & LAN2. LANLED2 is extension connector of LAN3 & LAN4 (G4 SKU only).

**Table 2.3: Front Panel LAN Indicator Connector (LANLED1)**

Pin	Signal	Pin	Signal
1	LAN1_LED0_ACT	2	LAN2_LED1_ACT
3	VCC3_LAN1LED	4	VCC3_LAN2LED
5	LAN1_LED1_1000M	6	LAN2_LED2_1000M
7	LAN1_LED2_100M	8	LAN2_LED0_100M
9	VCC3	10	NC

**Table 2.4: Front Panel LAN Indicator Connector (LANLED2)**

Pin	Signal	Pin	Signal
1	LAN3_LED1_ACT	2	LAN4_LED1_ACT
3	VCC3_LAN3LED	4	VCC3_LAN4LED
5	LAN3_LED2_1000M	6	LAN4_LED2_1000M
7	LAN3_LED0_100M	8	LAN4_LED0_100M
9	VCC3	10	NC



LANLED2 LANLED1

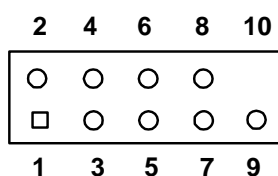

## 2.13 Serial ATA Interface (SATA0~5)

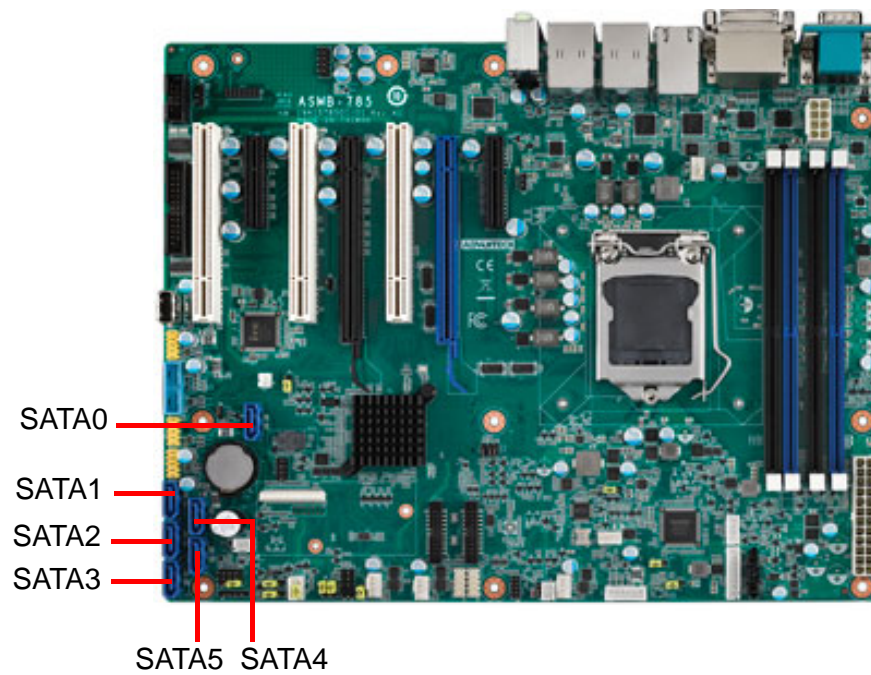

ASMB-785 features six high performance serial ATA III interfaces (up to 600 MB/s, blue connector).

## 2.14 PCI Slots (PCI\_SLOT1, PCI\_SLOT3, PCI\_SLOT5)

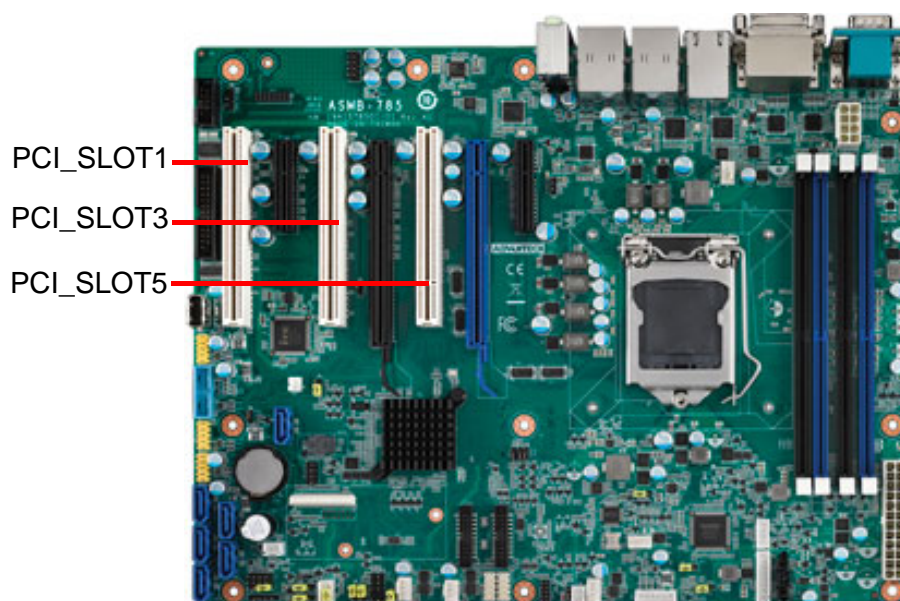

There are three 32bit PCI slots designed on ASMB-785, and default clock is 33 Mhz. PCI clock could be selected between 33 or 66 MHz by JPCICLK1 jumper.

## 2.15 PCIe x16 Expansion Slot (PCIEX16\_SLOT4 and PCIEX16\_SLOT6)

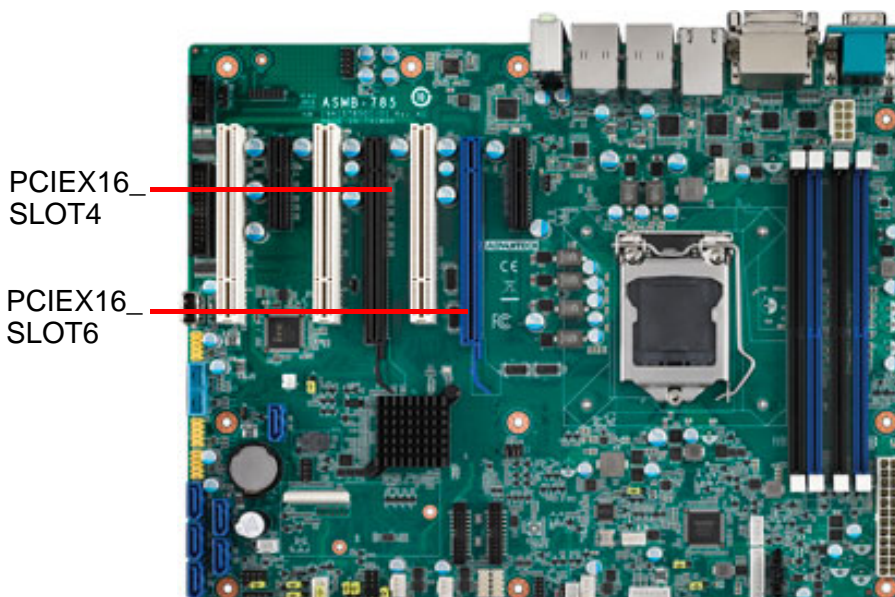

The ASMB-785 provides one PCIe x16 slots (x16 link) or two PCIe x16 slots (x8 link) for users to install add-on VGA cards when their applications require higher graphics performance than the CPU embedded graphics controller can provide, or high bandwidth demanded I/O cards, such as a frame grabber card, RAID card and a 10G LAN card. One x16 link on PCIEX16\_SLOT6 or two x8 link on PCIEX16\_SLOT6 & SLOT4 can be set via JPEG1 and JPEG2.

**Note!** *If there is only one PCIe x16 card it should be installed on PCIEx16\_SLOT6, and JPEG1 & JPEG2 is set as 1 PCIe x16 link (both JPEG1 and JPEG2 are 1-2 closed).*

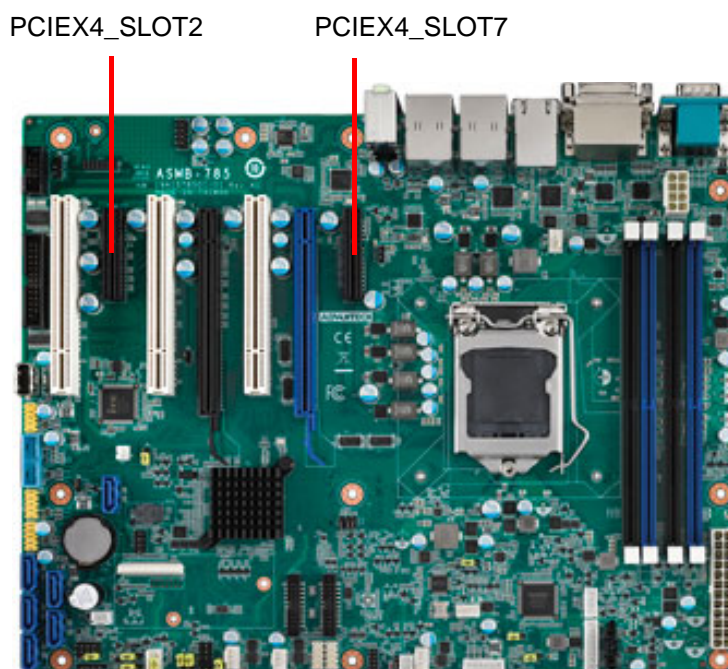

**Table 2.5: PCIEX16\_SLOT6 Configuration for Riser Card (JPEG1, JPEG2)**

Function	JPEG1	JPEG2	Riser Card Support
*PCIe x16			1U: AIMB-RF10F-01A1E 2U: AIMB-R431F-21A1E
PCIe x8/x8			2U: ASMB-RF3X8-21A1E
PCIe x8/x4/x4			2U: ASMB-RF348-21A1E

\* default setting

## 2.16 PCIe x4 Expansion Slot (PCIEX4\_SLOT2, PCIEX4\_SLOT7)



PCIEX4\_SLOT2 is Gen3 x4 link.

PCIEX4\_SLOT7 is Gen3 x4 link.

## 2.17 Auxiliary 8-pin power connector (ATX12V1)

For a fully configured system, we recommend that you use a power supply unit (PSU) that complies with ATX 12V Specification 2.0 (or later version). Do not forget to connect the 8-pin EATX12V power plug, otherwise the system will not boot.

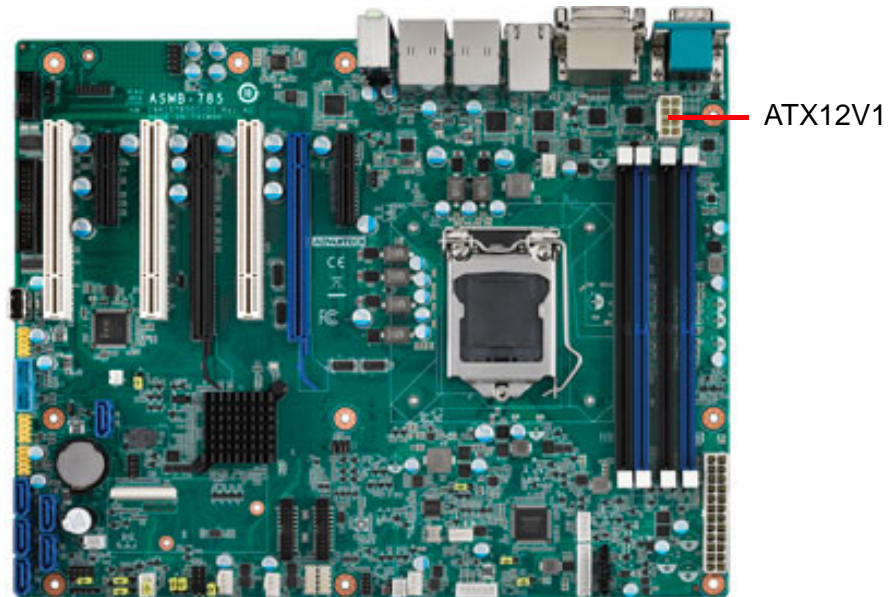

## 2.18 SPI Flash Connector(SPI\_CN1)

SPI flash card pin header can be connected to BIOS-flashing tools to flash the BIOS, during which ASMB-785 cannot be powered on

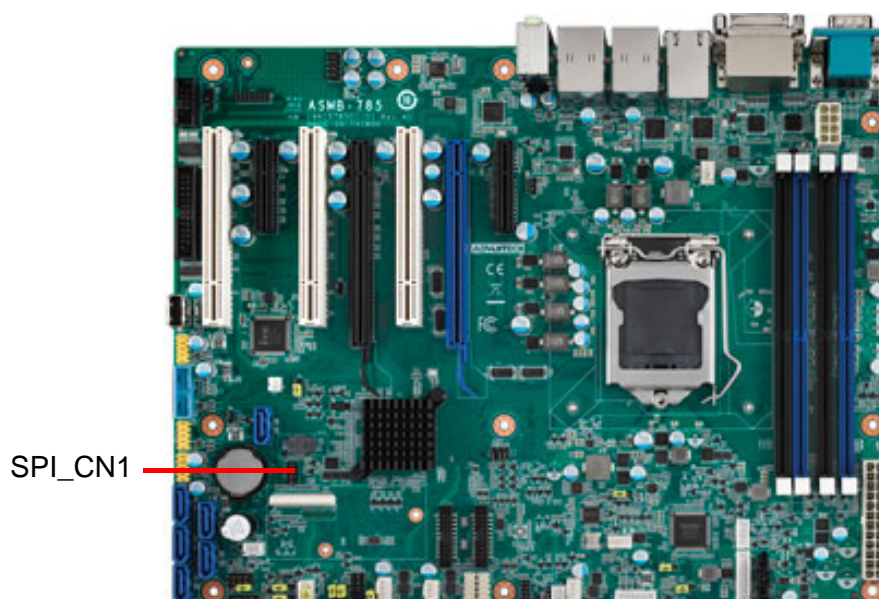

## 2.19 Low Pin Count Connector (LPC1)

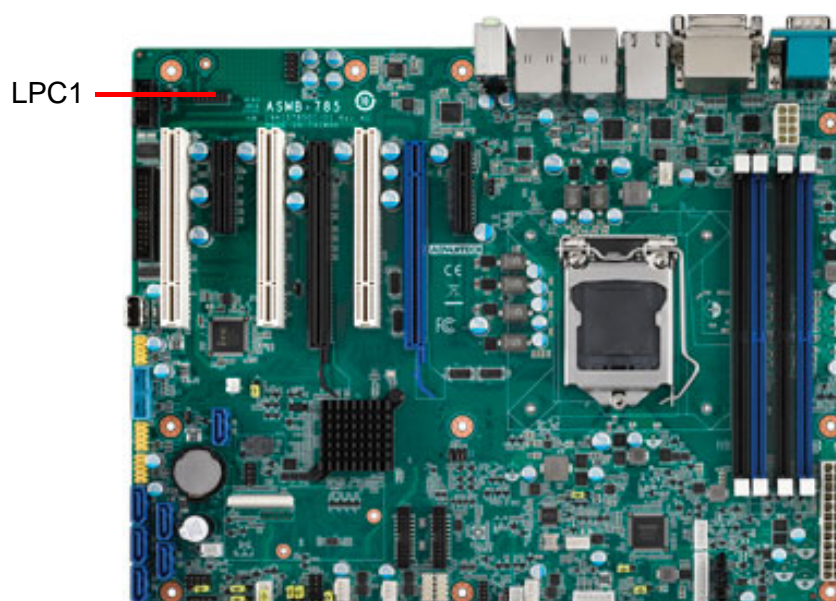

LPC connector on ASMB-785 is reserved for Advantech TPM and COM 232/485 modules. The slot-2 & 3 can't be used when Advantech's COM module is installed.

**Table 2.6: Advantech LPC Module List**

Advantech P/N	Description
PCA-TPM-00A1E	TPM Module
PCA-COM232-00A1E	4 ports RS-232 module connect to LPC connector

**Table 2.6: Advantech LPC Module List**

PCA-COM485-00A1E 4 ports RS-485 module connect to LPC connector

## 2.20 Parallel Port (LPT1)

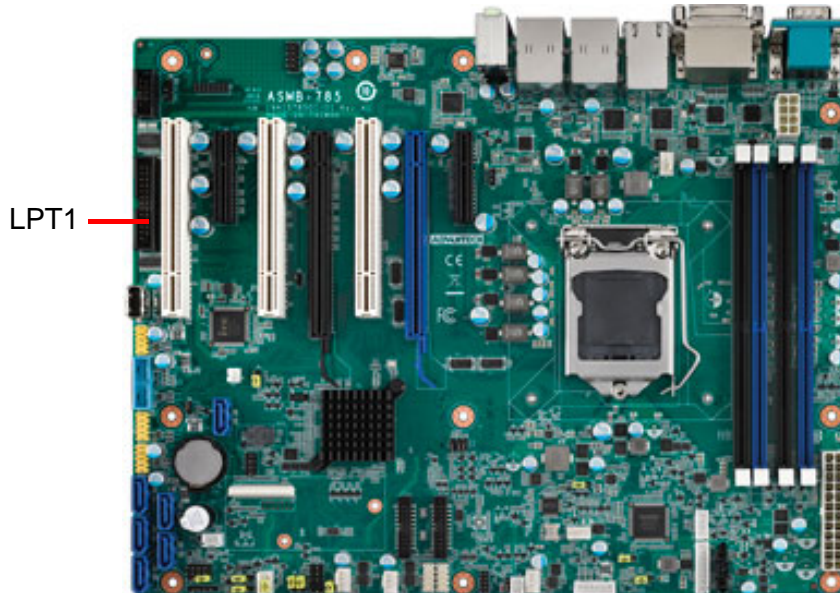

The parallel port is normally used to connect the motherboard to a printer. The ASMB-785 includes an onboard parallel port, accessed through a 25-pin flat-cable connector, LPT1.

## 2.21 PCI Clock Selection (JPCICLK1)

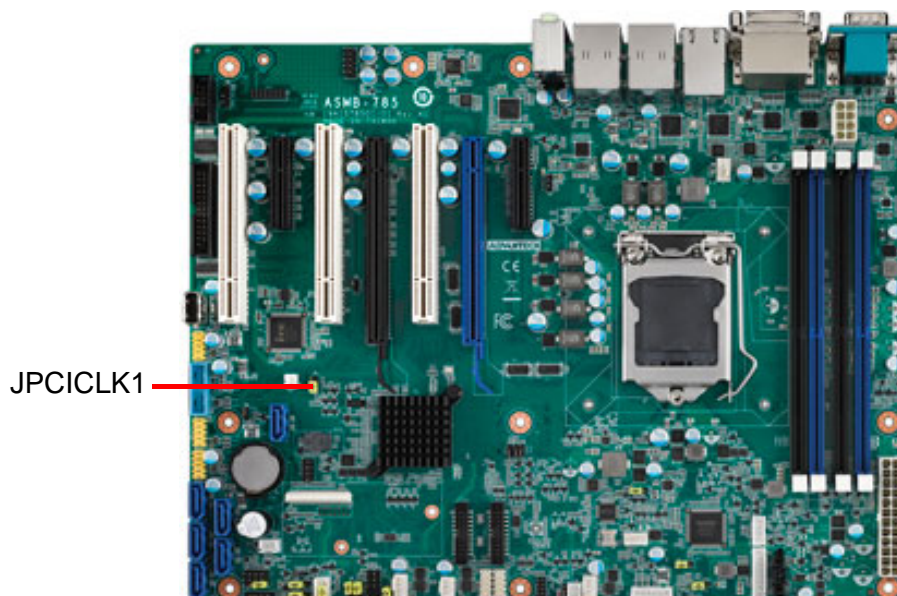

JPCICLK1 is a jumper to select a PCI slot clock speed between 66 or 33 MHz, the default setting is 33 MHz (2-3 closed).

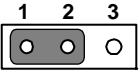
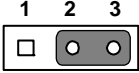

**Table 2.7: PCI Clock Selection (JPCICLK1)**

Function	Jumper Setting
PCI Clock at 66 MHz	 1-2 closed
*PCI Clock at 33 MHz	 2-3 closed
* default setting	



# Chapter 3

BIOS Operation

## 3.1 Introduction

With the AMI BIOS Setup program, you can modify BIOS settings and control the special features of your computer. The Setup program uses a number of menus for making changes and turning the special features on or off. This chapter describes the basic navigation of the ASMB-785 setup screens.



**Figure 3.1 Main setup screen**

AMI's BIOS ROM has a built-in Setup program that allows users to modify the basic system configuration. This information is stored in NVRAM area so it retains the Setup information when the power is turned off.

## 3.2 Entering BIOS Setup

Press <Del> or <Esc> at bootup to enter AMI BIOS Setup Utility, the Main Menu will appear on the screen. Use arrow keys to select among the items and press <Enter> to accept or enter the sub-menu.

When users first enter the BIOS Setup Utility, they enter the Main setup screen. Users can always return to the Main setup screen by navigating to the Main tab. There are two Main Setup options. They are described in this section. The Main BIOS Setup screen is shown below.

### 3.2.1 Main Menu

Press <Del> or <Esc> at bootup to enter AMI BIOS CMOS Setup Utility, the Main Menu will appear on the screen. Use arrow keys to select among the items and press <Enter> to accept or enter the sub-menu.



**Figure 3.2 Main setup screen**

The Main BIOS setup screen has two main frames. The left frame displays all the options that can be configured. Grayed-out options cannot be configured; options in blue can be. The right frame displays the key legend.

Above the key legend is an area reserved for a text message. When an option is selected in the left frame, it is highlighted in white. Often a text message will accompany it.

#### ■ System time / System date

Use this option to change the system time and date. Highlight System Time or System Date using the <Arrow> keys. Enter new values through the keyboard. Press the <Tab> key or the <Arrow> keys to move between fields. The date must be entered in MM/DD/YY format. The time must be entered in HH:MM:SS format.

### 3.2.2 Advanced BIOS Features Setup

Select the Advanced tab from the ASMB-785 setup screen to enter the Advanced BIOS setup screen. You can select any of the items in the left frame of the screen, such as CPU configuration, to go to the sub menu for that item. You can display an Advanced BIOS Setup option by highlighting it using the <Arrow> keys. All Advanced BIOS Setup options are described in this section. The Advanced BIOS Setup screens are shown below. The sub menus are described on the following pages.

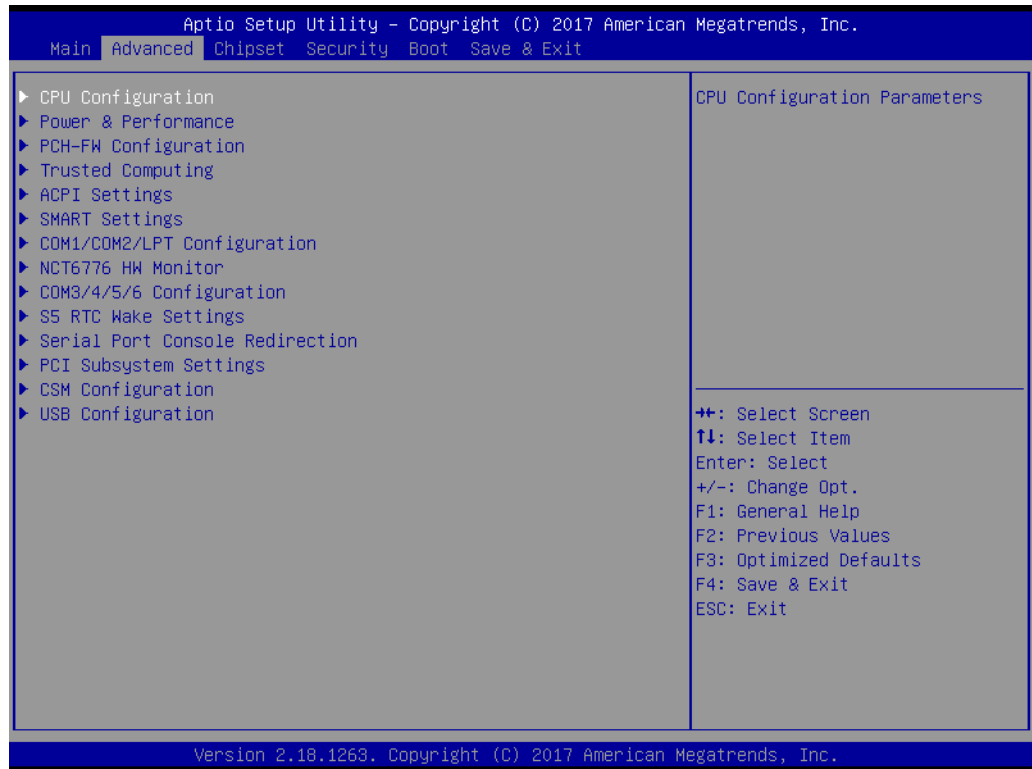

**Figure 3.3 Advanced BIOS features setup screen**

### 3.2.2.1 CPU Configuration

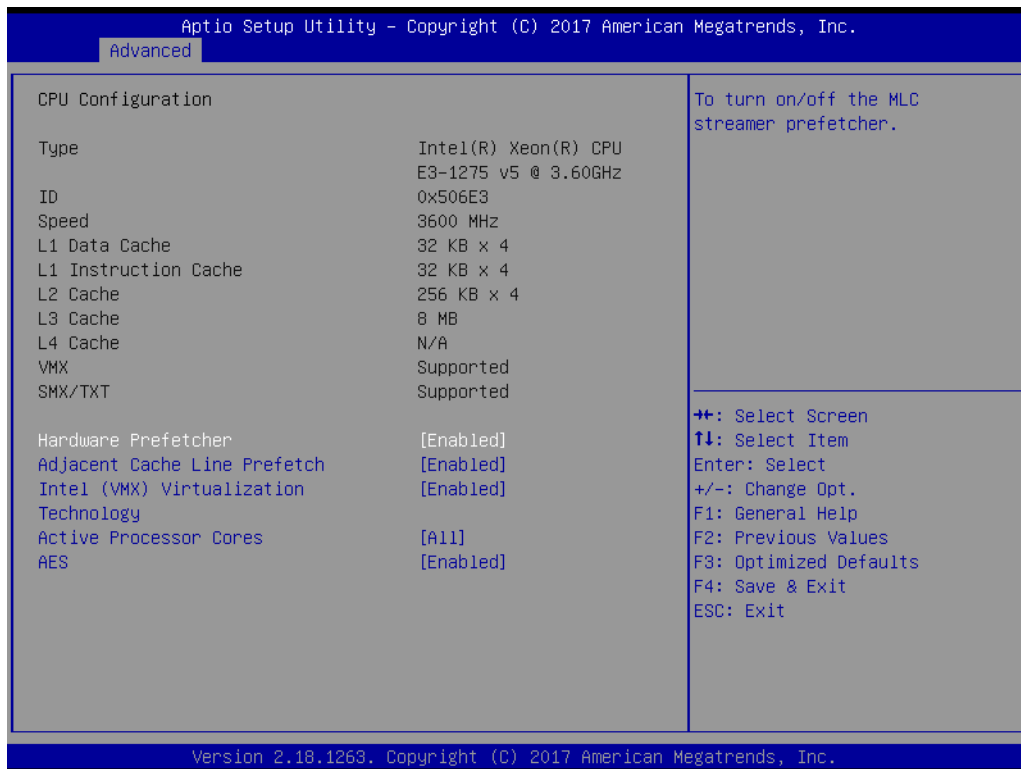

**Figure 3.4 CPU Configuration**

- **Hardware Prefetcher**

Hardware Prefetcher is a technique that fetches instructions and/or data from memory into the CPU cache memory well before the CPU needs it, so that it can improve the load-to-use latency. You may choose to enable or disable it.
- **Adjacent Cache Line Prefetch**

The Adjacent Cache-Line Prefetch mechanism, like automatic hardware prefetch, operates without programmer intervention. When enabled through the BIOS, two 64-byte cache lines are fetched into a 128-byte sector, regardless of whether the additional cache line has been requested or not. You may choose to enable or disable it.
- **Intel (VMX) Virtualization Technology**

This feature is used to enable or disable the Intel Virtualization Technology (IVT) extension. It allows multiple operating systems to run simultaneously on the same system. It does this by creating virtual machines, each running its own x86 operating system.
- **Active Processor Cores**

Number of cores to enable in each processor package.
- **AES**

This item is to enable or disable CPU advanced encryption standard instructions.

### 3.2.2.2 Power & Performance

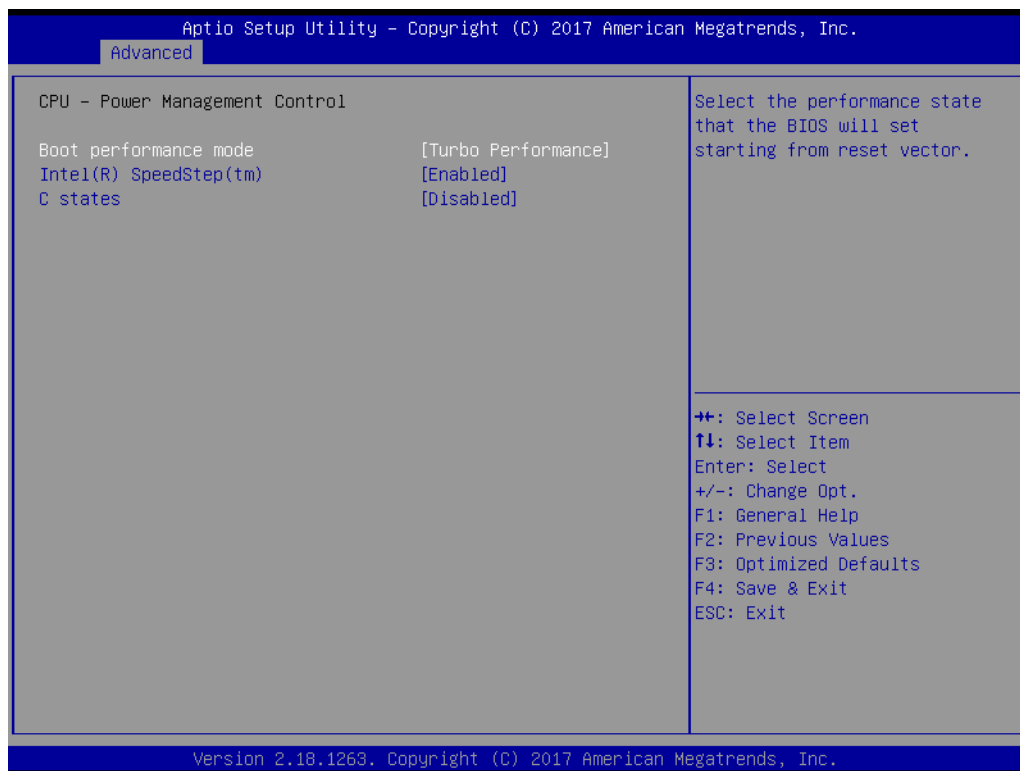

**Figure 3.5 CPU Power Management Control**

- **Boot performance mode**  
Select the performance state that the BIOS will set before OS handoff.
- **Intel SpeedStep (tm)**  
Allows more than two frequency ranges to be supported



- **C States**

Enable/Disable CPU power management. Allows CPU to go to C states when it's not 100% utilized.

### 3.2.2.3 PCH-FW Configuration

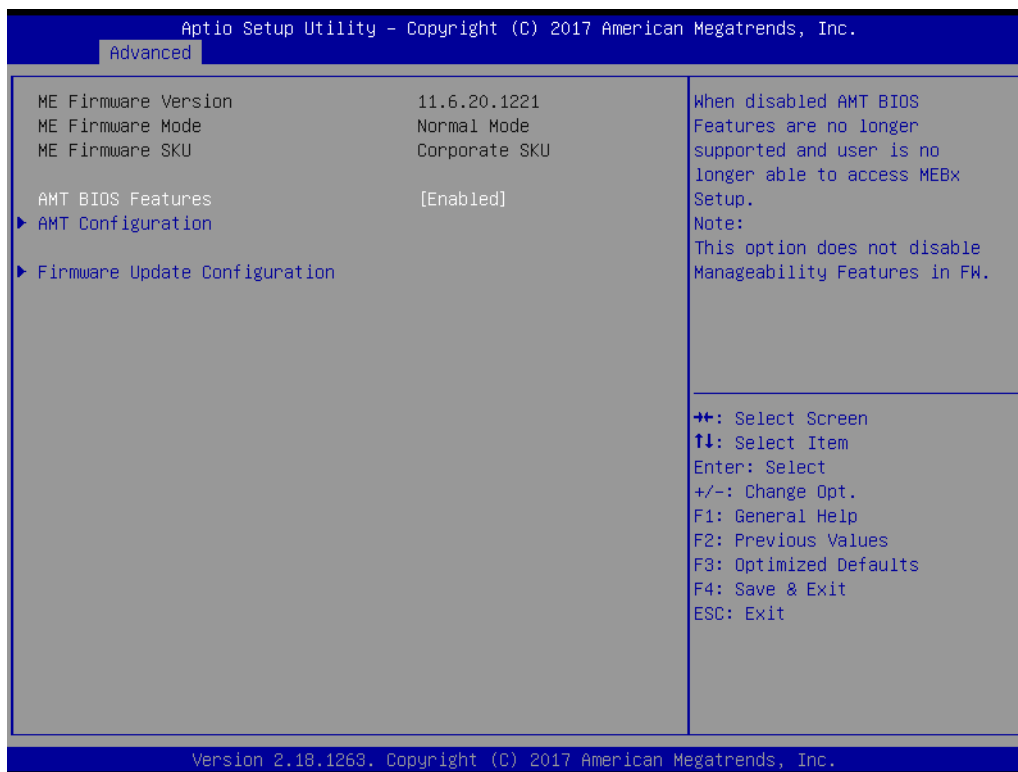

**Figure 3.6 Intel ME FW Configuration Information**

This page shows the Intel ME configuration.

- **AMI BIOS Features**

When "Disable", AMT BIOS features are no longer supported and user is no longer able to access MEBx setup. This option does not disable manageability features in FW.

### 3.2.2.4 AMT Configuration

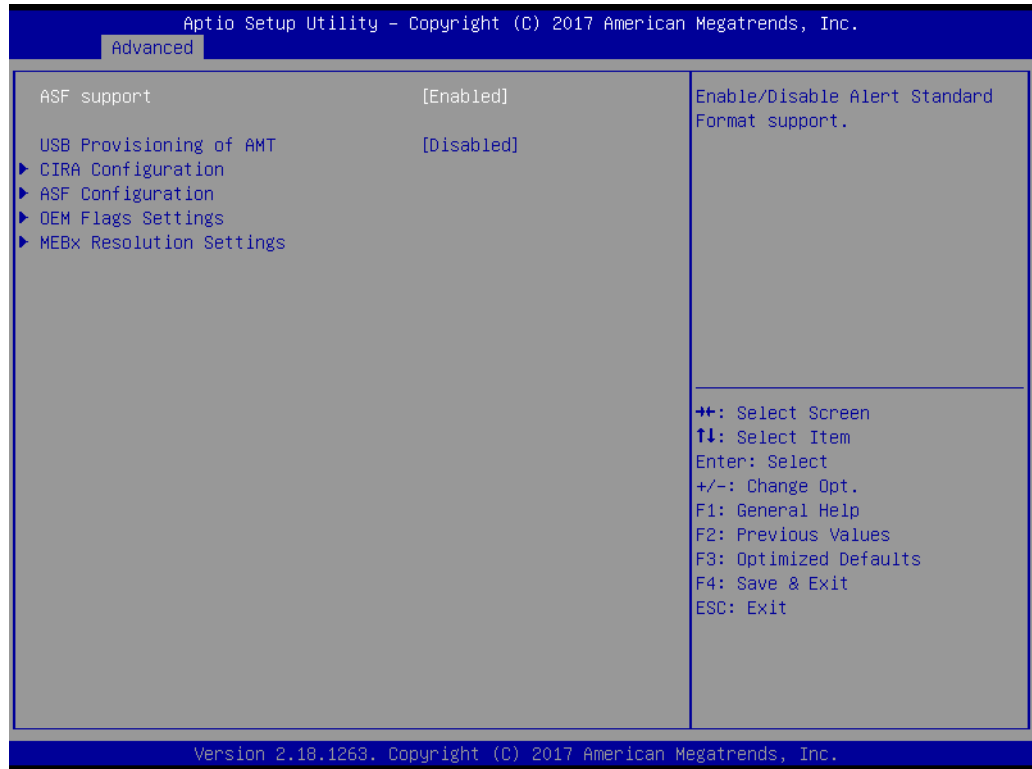

**Figure 3.7 ASF Support**

- **USB Provisioning of AMT**  
To disabled or enabled USB Provisioning of AMT.
- **CIRA Configuration**  
To configure remote assistance process parameters.



**Figure 3.8 Activate Remote Assistance Process**

### ■ ASF Configuration

To configure alert standard format parameters.

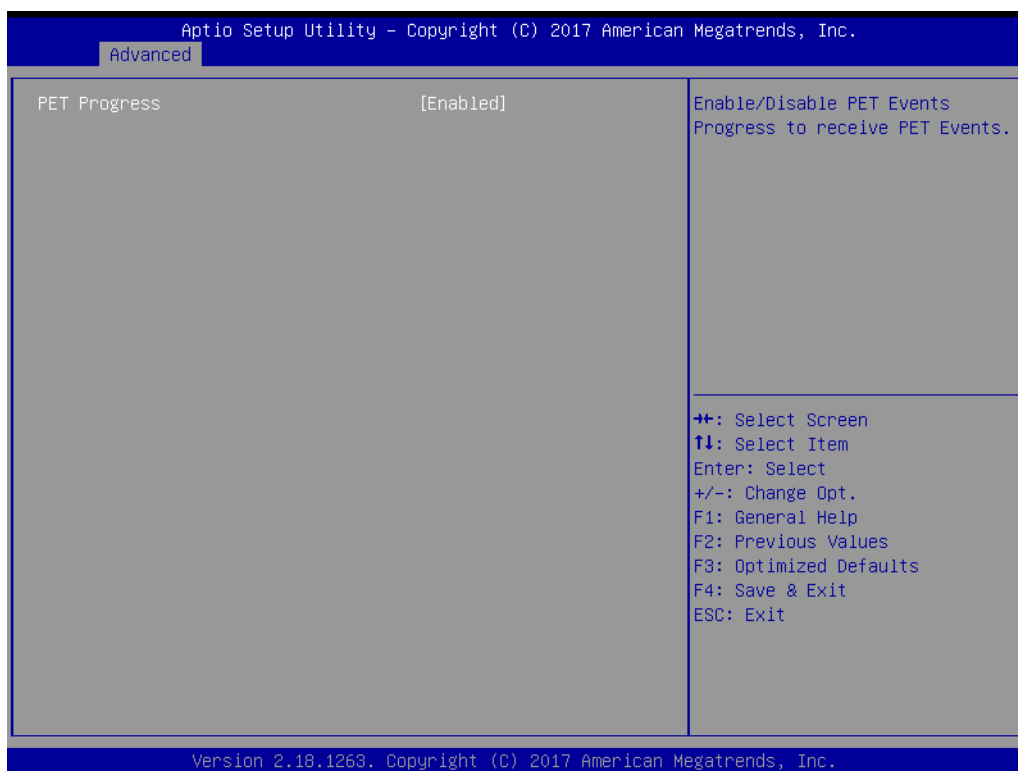

**Figure 3.9 PET Progress**

### ■ OEM Flags Settings

To configure OEM flags



**Figure 3.10 OEM Flags Settings**

- **MEBx Resolution Settings**  
Resolution settings for MEBx display modes

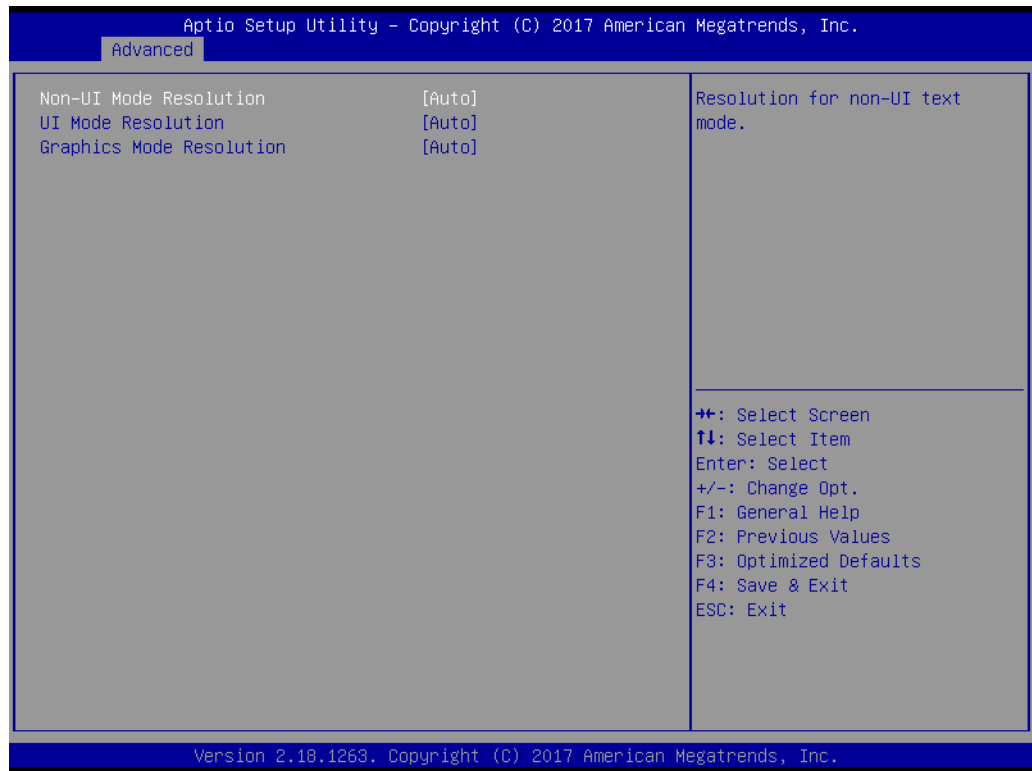

**Figure 3.11 MEBx Resolution Settings**

### 3.2.2.5 Firmware Update Configuration

To enable or disable ME FW Image Re-Flash function.



**Figure 3.12 ME FW Image Re-Flash**

### 3.2.2.6 Trusted Computing

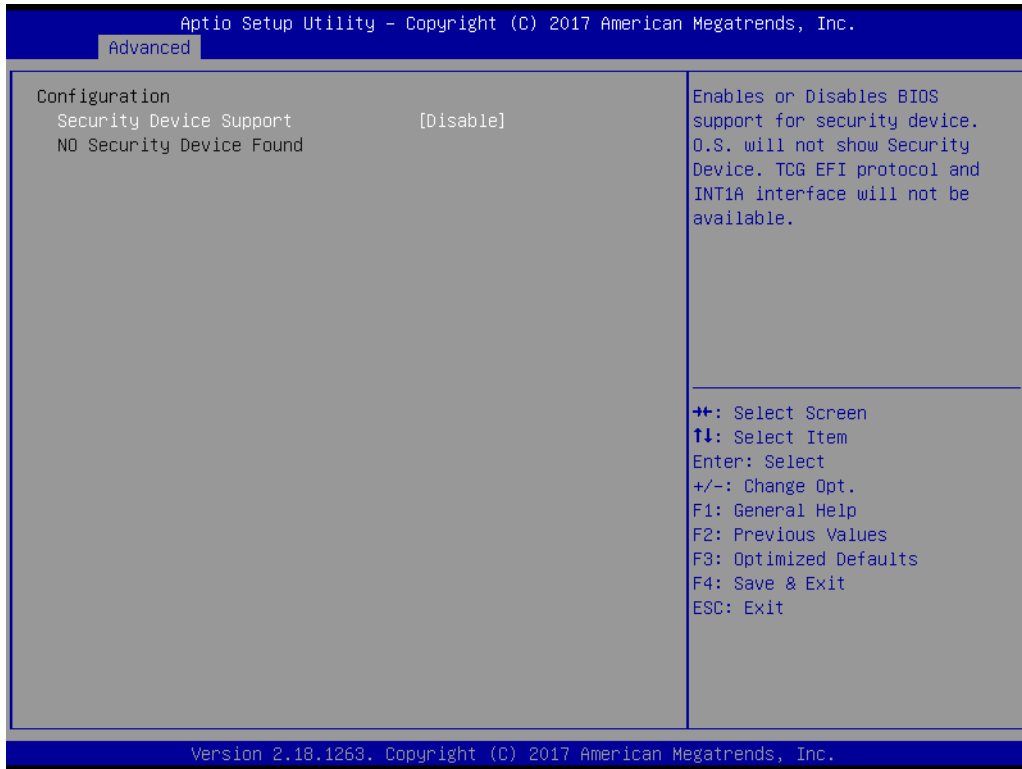
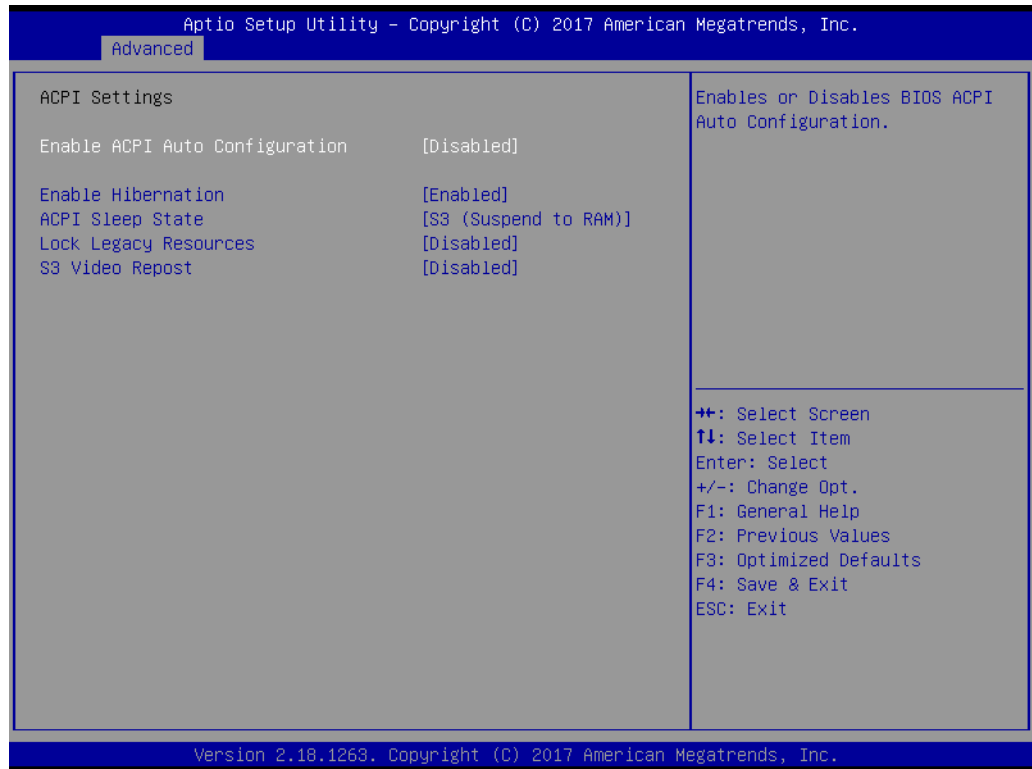

**Figure 3.13 TPM Settings**

- **Security Device Support**

“Enable” or “disable” TPM Support. You can purchase Advantech LPC TPM module to enable TPM function. P/N: PCA-TPM-00A1E

### 3.2.2.7 ACPI Settings



**Figure 3.14 ACPI Settings**

- **Enable ACPI Auto Configuration**  
"Enable" or "Disable" BIOS ACPI Auto Configuration.
- **Enable Hibernation**  
"Enable" or "disable" Hibernation.
- **ACPI Sleep State**  
Specifies the ACPI sleep state when the system enters suspend.
- **Lock Legacy Resources**  
"Enable" or "Disable" Lock Legacy Resources.
- **S3 Video Repost**  
This item is to enabled or disabled S3 video repost.

### 3.2.2.8 SMART Settings



Figure 3.15 SMART Setting

- **SMART Self Test**

This item is to enable or disable SMART self test on all HDDs during post.

### 3.2.2.9 COM1/COM2/LPT Configuration

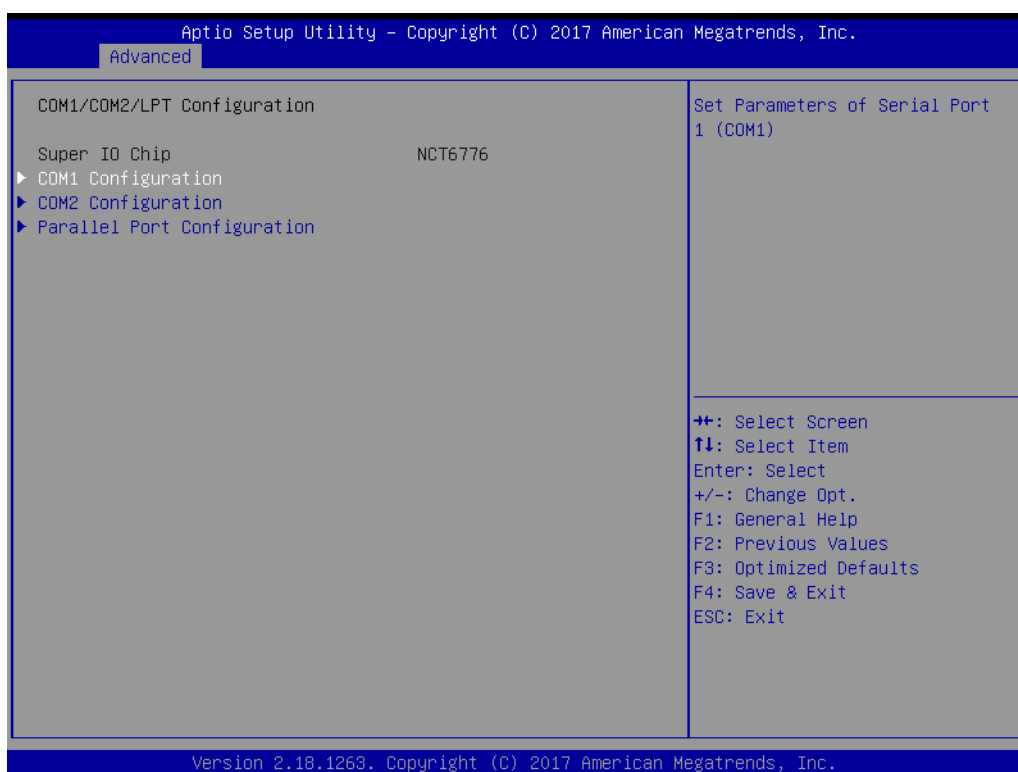
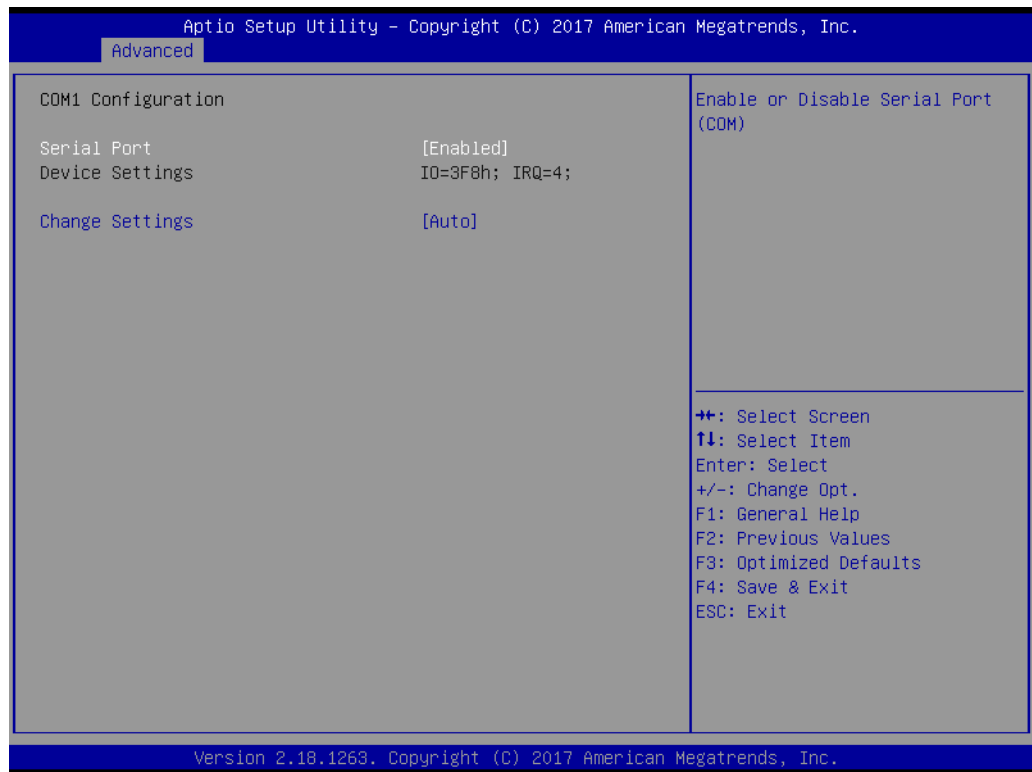
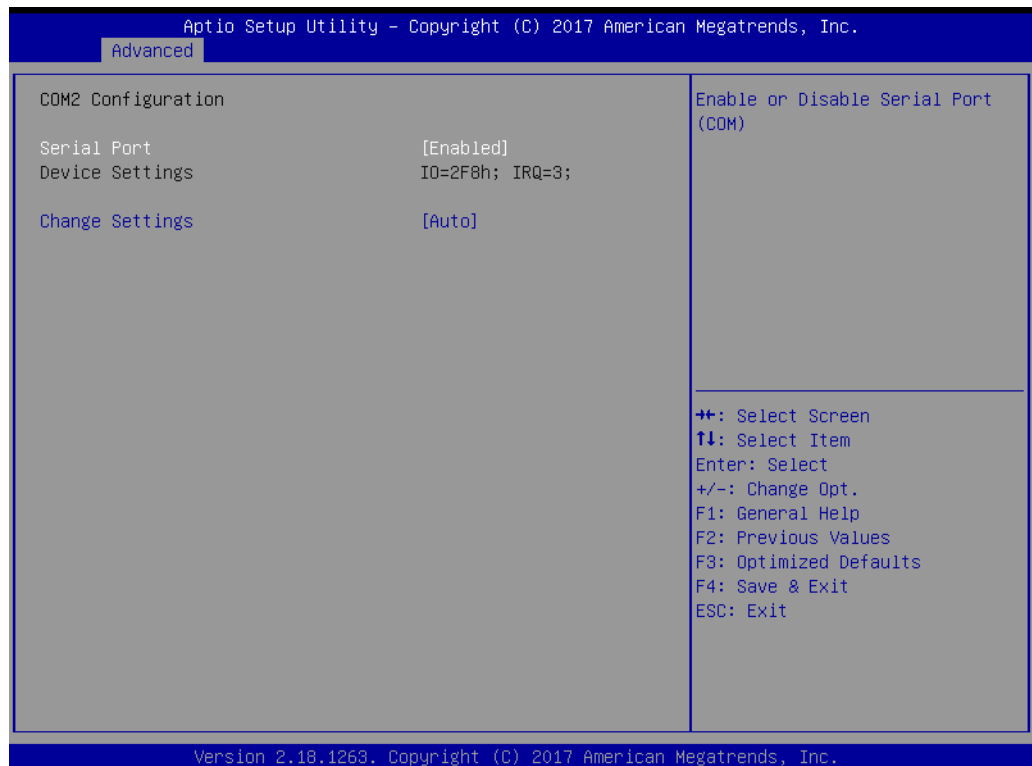

Figure 3.16 COM1/COM2/LPT Configuration



**Figure 3.17 COM1 Configuration**



**Figure 3.18 COM2 Configuration**

**COM1 Configuration**

- **Serial Port**  
“Enable” or “disable” COM1.
- **Change Settings**  
Select optimal settings for COM1.



## COM2 Configuration

- **Serial Port**  
“Enable” or “disable” COM2.
- **Change Settings**  
Select optimal settings for COM2.

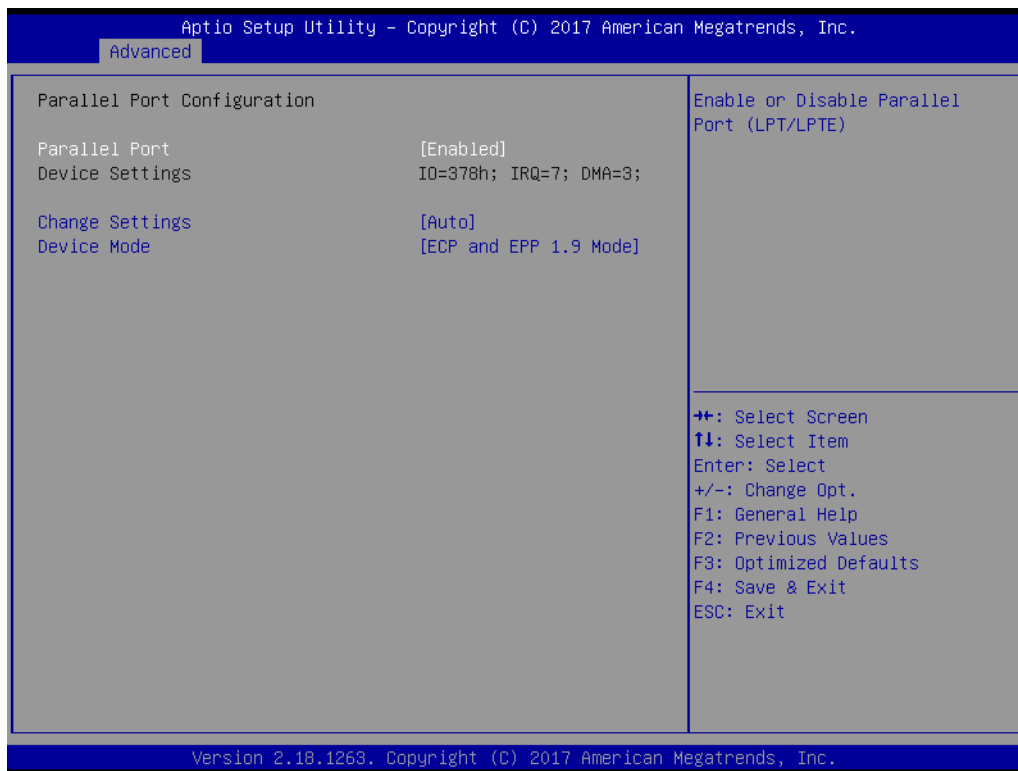

**Figure 3.19 Parallel Port Configuration**

- **Parallel Port Configuration**  
Enable or disable Parallel Port.

### 3.2.2.10 NCT6776 HW Monitor

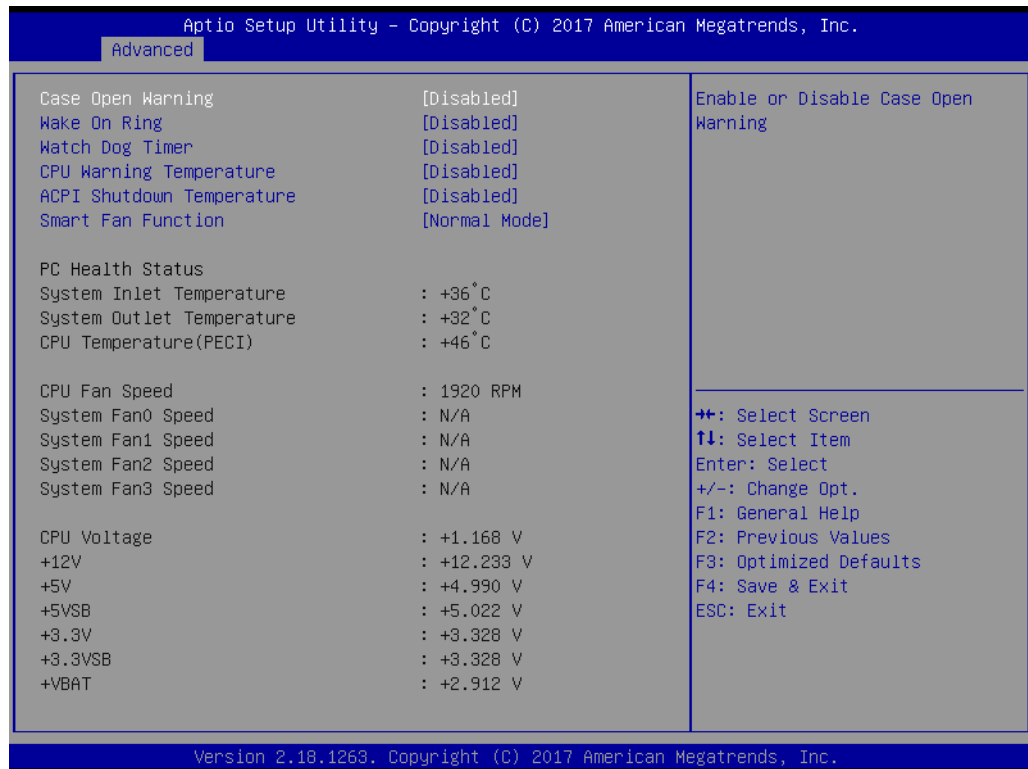

**Figure 3.20 PC Health Status**

- **Case Open Warning**  
Enable/Disable the chassis Intrusion monitoring function. When enabled and the case is opened, a warning message will show in post screen.
- **Wake On Ring**  
Enable/Disable Wake On Ring Function.
- **Watch Dog Timer**  
Enable/Disable Watch Dog Timer Function.
- **CPU Warning Temperature**  
Use this to set the CPU warning temperature threshold. When the system reaches the warning temperature, the speaker will beep.
- **ACPI Shutdown Temperature**  
Use this to set the ACPI shutdown temperature threshold. When the system reaches the shutdown temperature, it will be automatically shut down by ACPI OS to protect the system from overheat damage.
- **Smart Fan Function**  
ASMB-785 offers three different fan curves:
  - 1.Normal Mode - Enable smart fan for normal system configuration.
  - 2.Quiet Mode - Enable smart fan for quiet system with no expansion cards.
  - 3.Disable - All fans run as full speed.

### 3.2.2.11 COM3/4/5/6 Configuration



**Figure 3.21 COM3/4/5/6 Configuration**

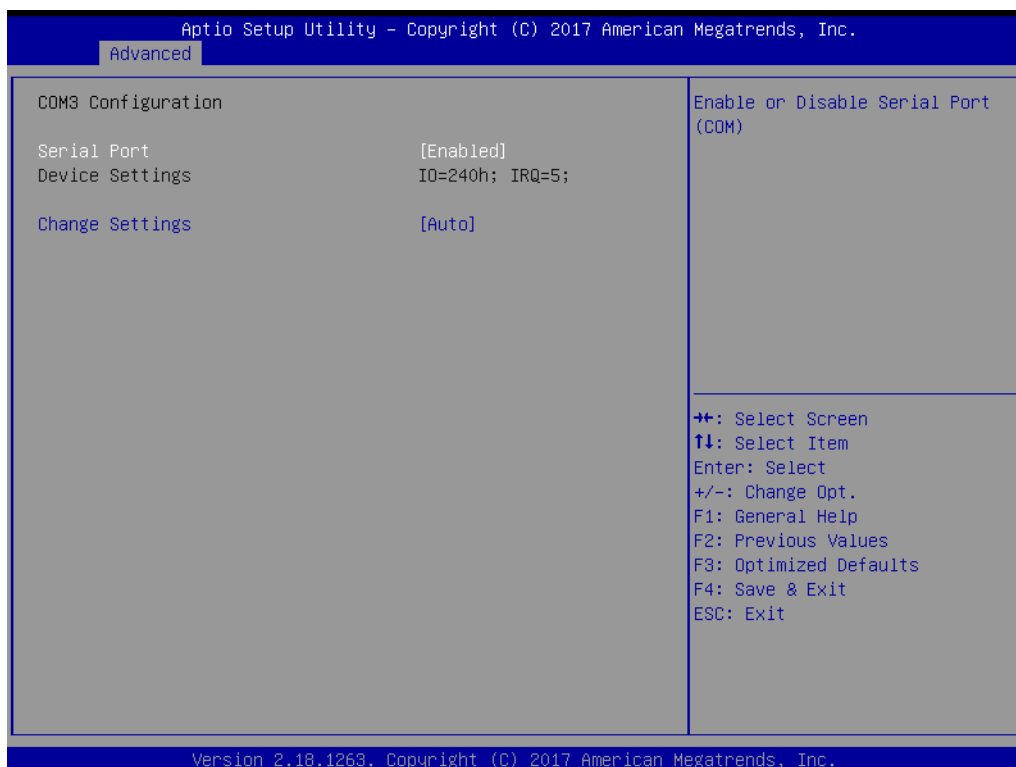

**Figure 3.22 COM3 Configuration**

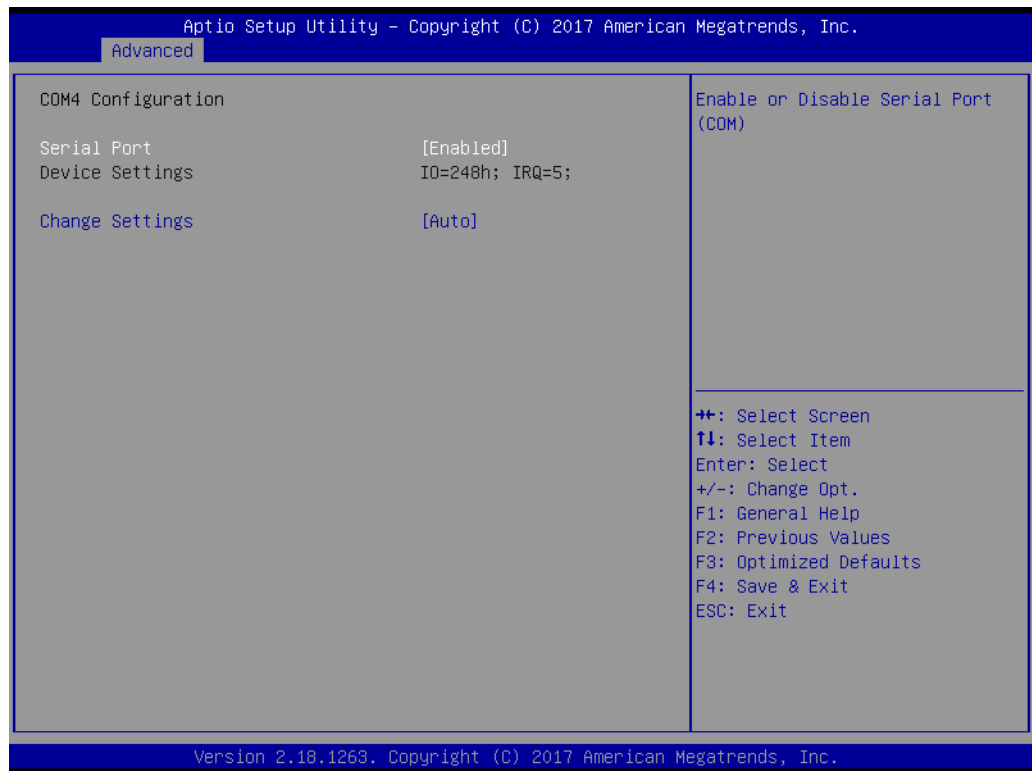

**Figure 3.23 COM4 Configuration**

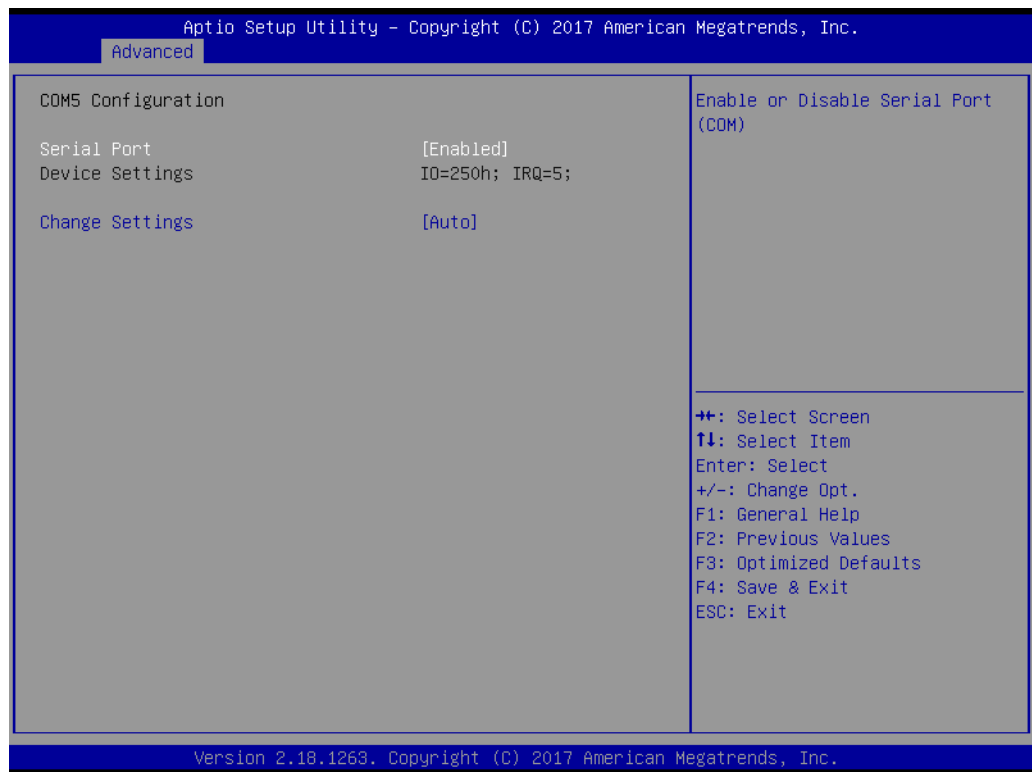

**Figure 3.24 COM5 Configuration**

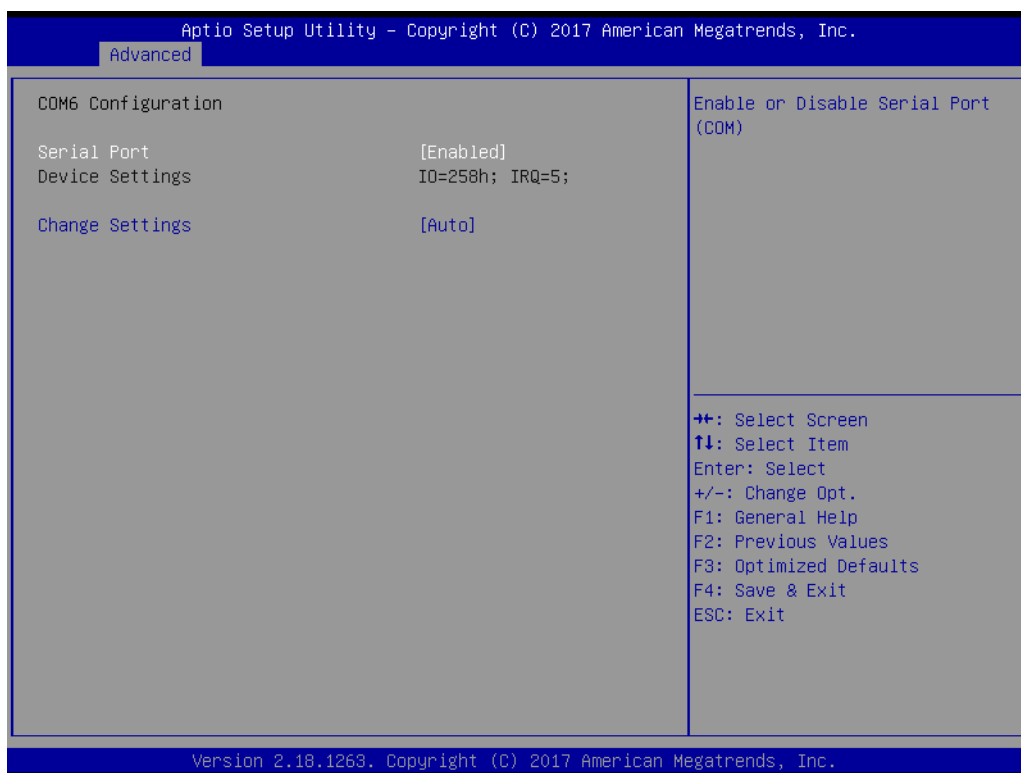

**Figure 3.25 COM6 Configuration**

### COM3 Configuration

- **Serial Port**  
"Enable" or "Disable" COM3.
- **Change Settings**  
Select optimal settings for COM3.

### COM4 Configuration

- **Serial Port**  
"Enable" or "Disable" COM4.
- **Change Settings**  
Select optimal settings for COM4.

### COM5 Configuration

- **Serial Port**  
"Enable" or "Disable" COM5.
- **Change Settings**  
Select optimal settings for COM5.

### COM6 Configuration

- **Serial Port**  
"Enable" or "Disable" COM6.
- **Change Settings**  
Select optimal settings for COM6.

### 3.2.2.12 PCA-COM232/COM485 Configuration

**Note!** (This item only shows when a PCA COM module is installed)

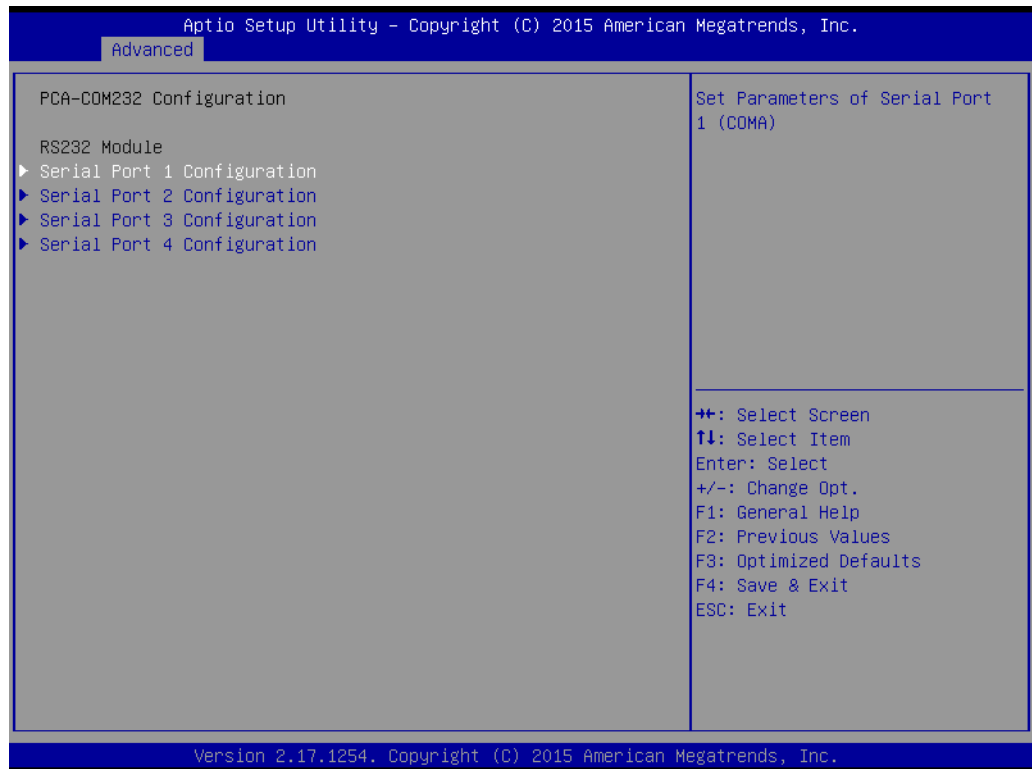

**Figure 3.26 PCA-COM232 Configuration**

ASMB-785 offers extra four COM ports through LPC connector.

You need to purchase "PCA-COM232-00A1E" or "PCA-COM485-00A1E" then install it in the LPC connector.

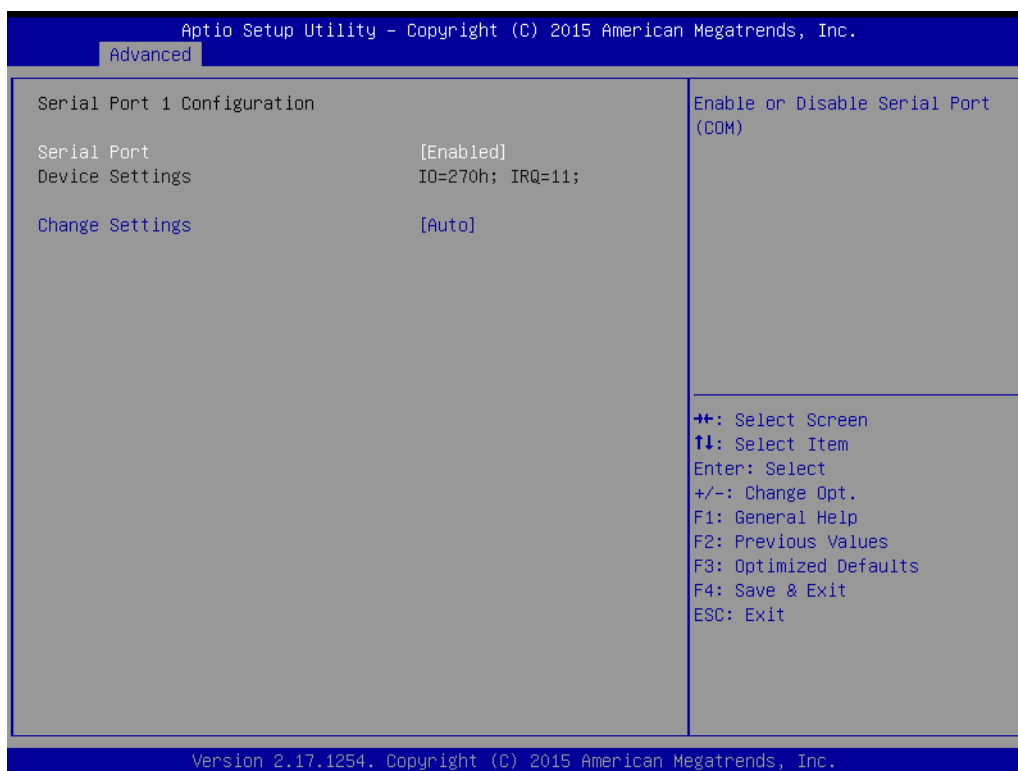

**Figure 3.27 Serial Port 1 Configuration**

### Serial Port 1 Configuration Legacy Console Redirection Settings

- **Serial Port**  
"Enable" or "Disable" Serial Port 1.
- **Change Settings**  
Select optimal settings for Serial Port 1.

### Serial Port 2 Configuration

- **Serial Port**  
"Enable" or "Disable" Serial Port 2.
- **Change Settings**  
Select optimal settings for Serial Port 2.

### Serial Port 3 Configuration

- **Serial Port**  
"Enable" or "Disable" Serial Port 3.
- **Change Settings**  
Select optimal settings for Serial Port 3.

### Serial Port 4 Configuration

- **Serial Port**  
"Enable" or "Disable" Serial Port 4.
- **Change Settings**  
Select optimal settings for Serial Port 4.

### 3.2.2.13 S5 RTC Wake Settings

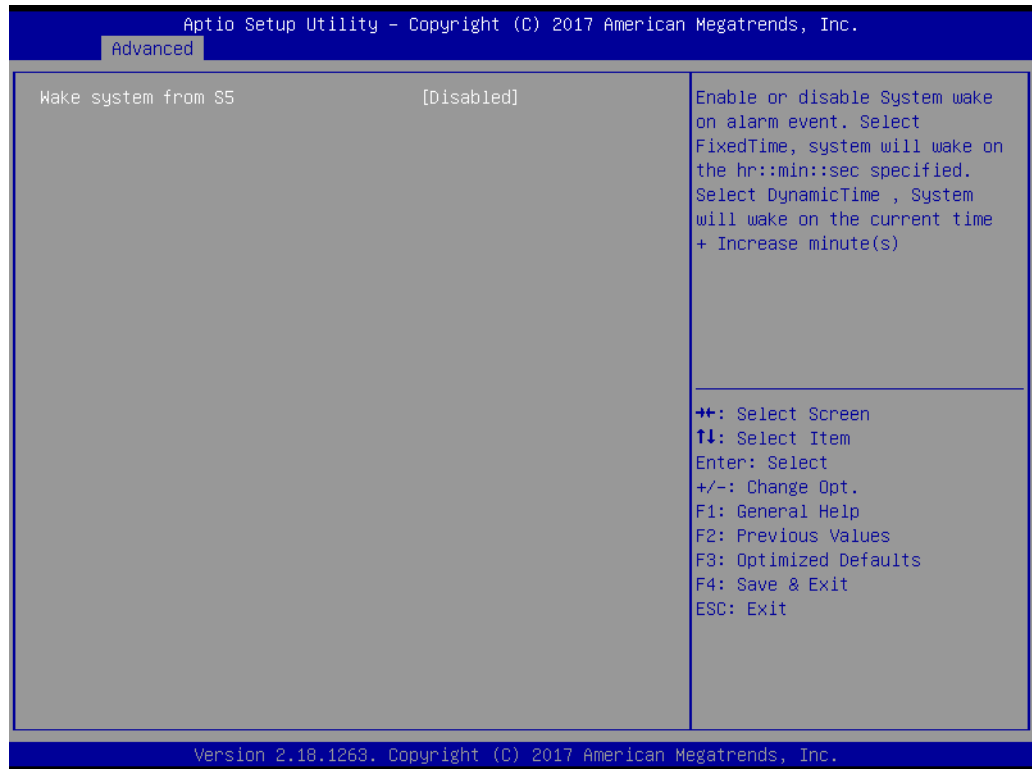
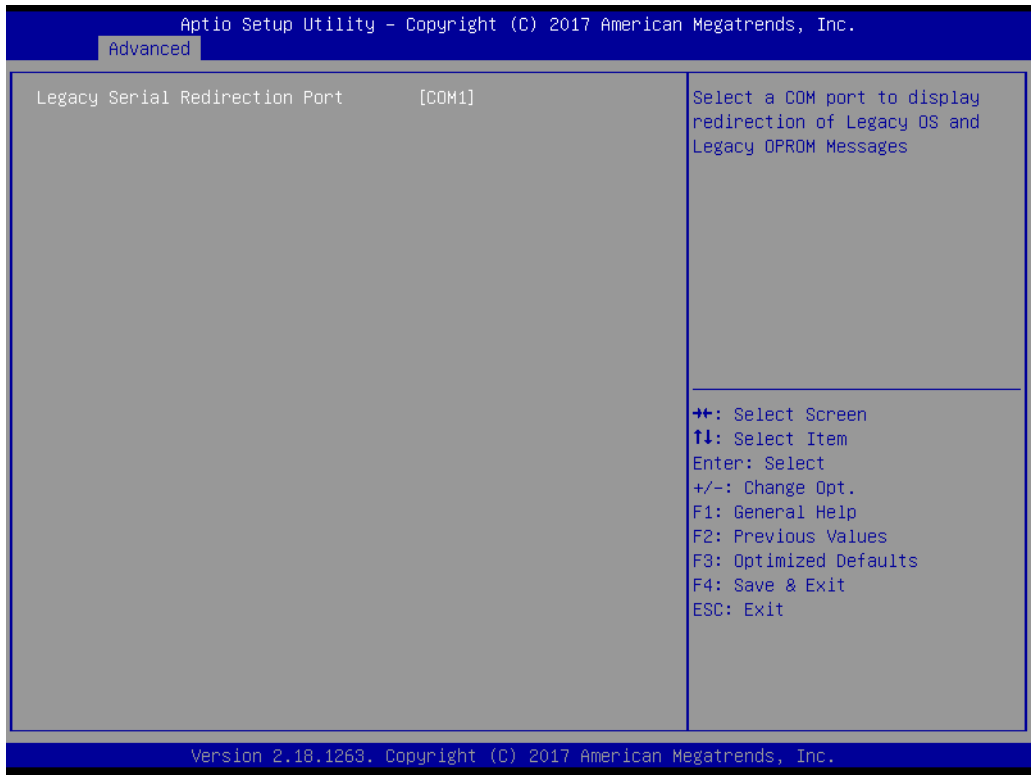
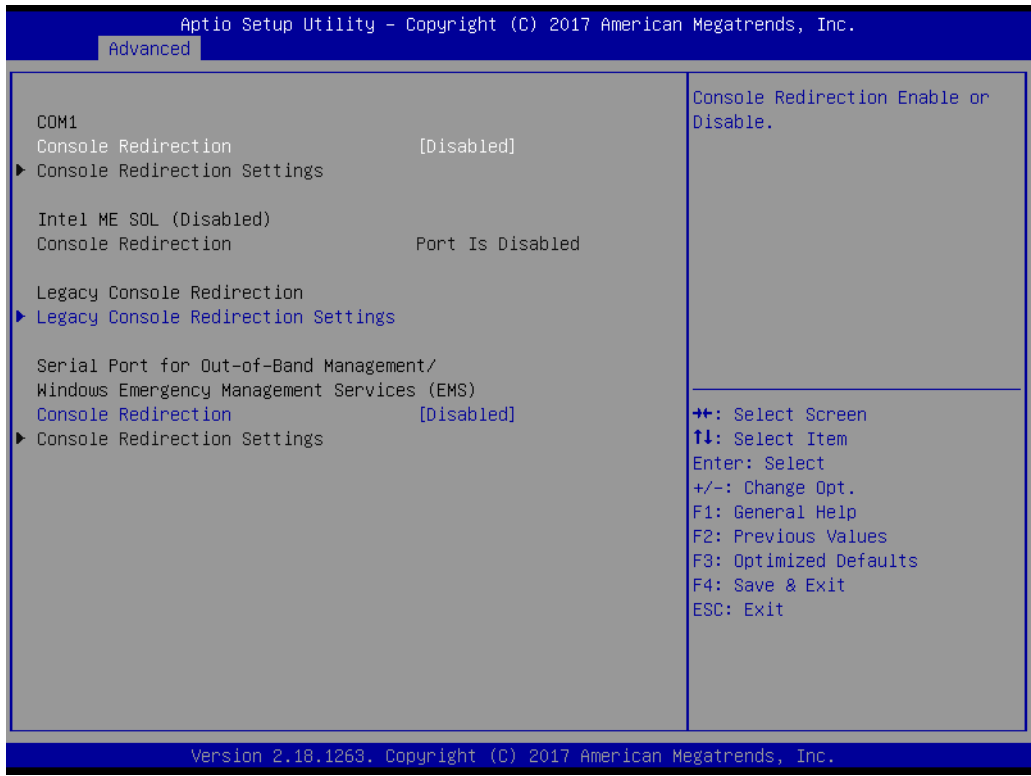

**Figure 3.28 S5 RTC Wake Settings**

- **Wake system from S5**  
Enable/Disable system wake on alarm event. Select fixed time, system will wake on the hr::min::sec specified. Selected dynamic time, system will wake on the current time + increase minutes.



### 3.2.2.14 Serial Port Console Redirection



**Figure 3.29 Serial Port Console Redirection**

- **Console Redirection**

Enable or disable the console redirection feature.

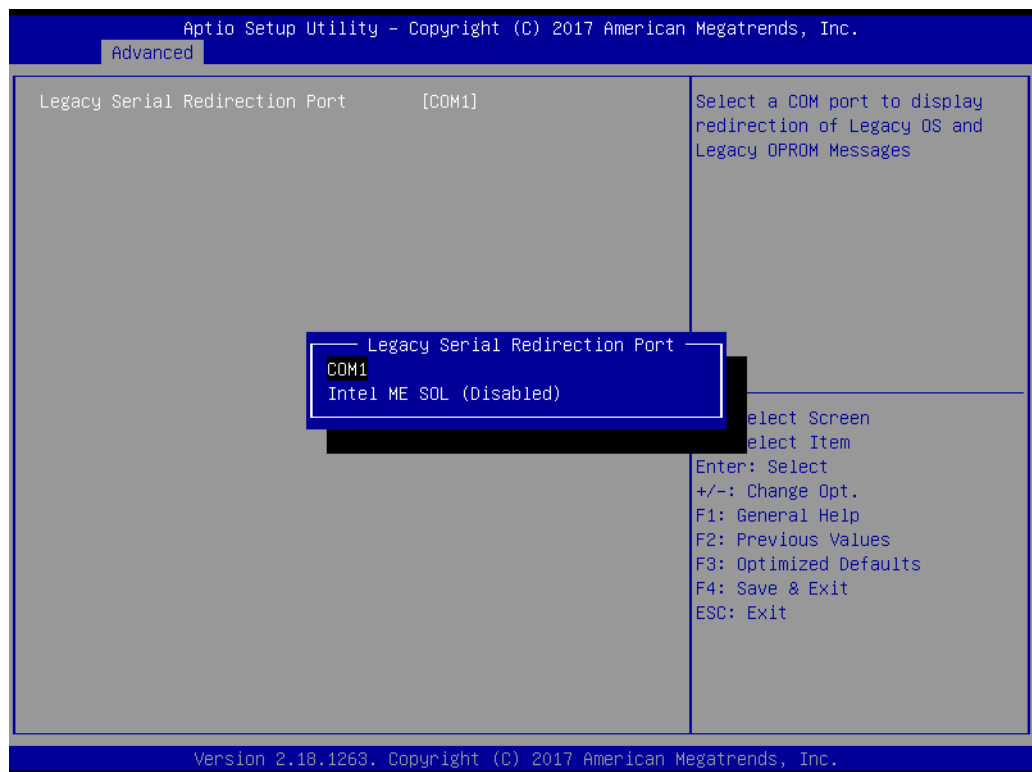
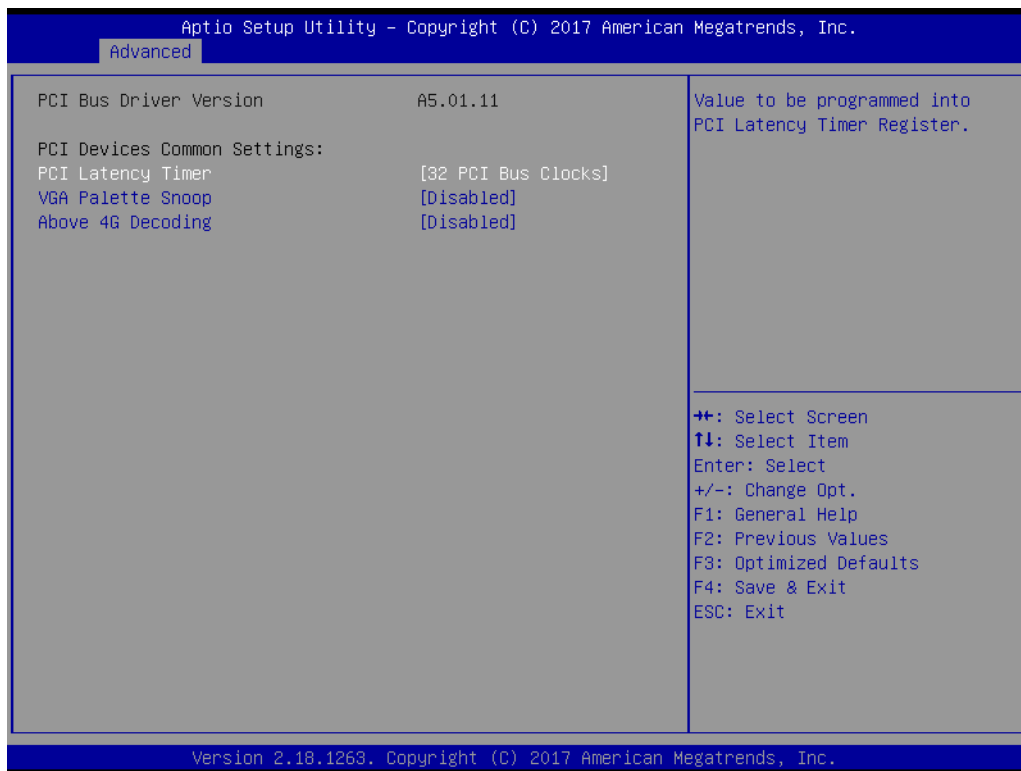

**Figure 3.30 Legacy Console Redirection Settings**

- **Legacy Console Redirection Settings**

Select a COM port to display redirection of legacy OS and legacy OpROM messages.

### 3.2.2.15 PCI Subsystem Settings



**Figure 3.31 PCI subsystem settings screen**

- **PCI Latency Timer**  
Value in units of PCI clocks for PCI device latency timer register.
- **VGA Palette Snoop**  
This item is designed to solve problems caused by some non-standard VGA cards.
- **Above 4G Decoding**  
Enable/Disable 64bit capable devices to be decoded in above 4G address space (only if system supports 64 bit PCI decoding).

### 3.2.2.16 CSM Configuration



Figure 3.32 CSM Configuration

- **CSM Support**  
To enable or disable CSM support.
- **GateA20 Active**  
This item is useful when RT code is executed above 1MB. When this is set to "UPON RQUEST", GA20 can be disabled using BIOS services. When it's set to "Always", it does not allow disabling of GA20.
- **Option ROM Messages**  
"Force BIOS or Keep Current" to set the display mode for Option ROM
- **INT19 Trap Response**  
This item executes the Interrupt trap response for the OpROM immediately. When set to "Immediate", the trap will be executed right away. When it's set as "Postponed", the trap will be executed during legacy boot.
- **Boot option filter**  
This option controls Legacy/UEFI ROMs priority.
- **Option ROM execution**
- **Network**  
Controls the execution of UEFI and legacy PXE OpROM
- **Storage**  
Controls the execution of UEFI and Legacy Storage OpROM
- **Video**  
Controls the execution of UEFI and Legacy Video OpROM
- **Other PCI devices**  
Determines execution of OpROM policy for devices other than Network, Storage or Video.

### 3.2.2.17 USB Configuration

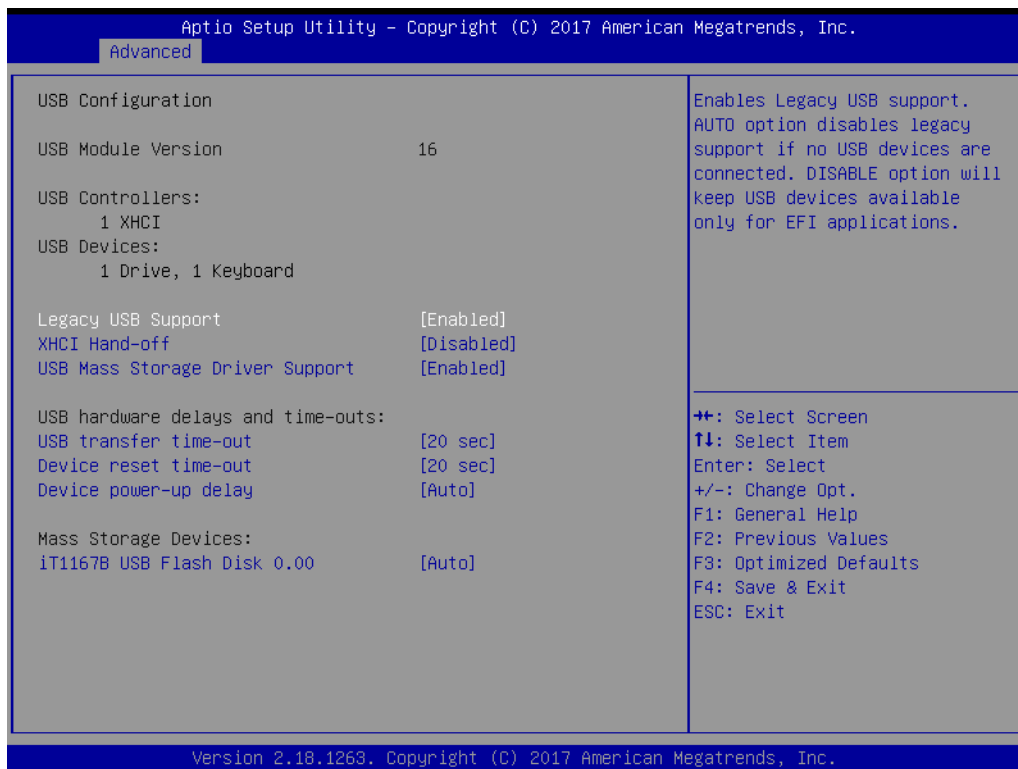

**Figure 3.33 USB Configuration**

- **Legacy USB Support**  
This is for supporting USB devices under legacy OS such as DOS. When choosing "AUTO", the system will automatically detect if any USB device is plugged into the computer and enable USB legacy mode and disable USB legacy mode when no USB device is plugged in.
- **XHCI Hand-off**  
Enables or disables support for OS without XHCI hand-off features.
- **USB Mass Storage Driver Support**  
To enable or disable USB mass storage driver support.
- **USB transfer time-out**  
Allows you to select the USB transfer time-out value. [1,5,10,20sec]
- **Device reset time-out**  
Allows you to select the USB device reset time-out value. [10,20,30,40 sec]
- **Device power-up delay**  
This item appears only when you set the Device power-up delay item to [manual].

### 3.2.3 Chipset

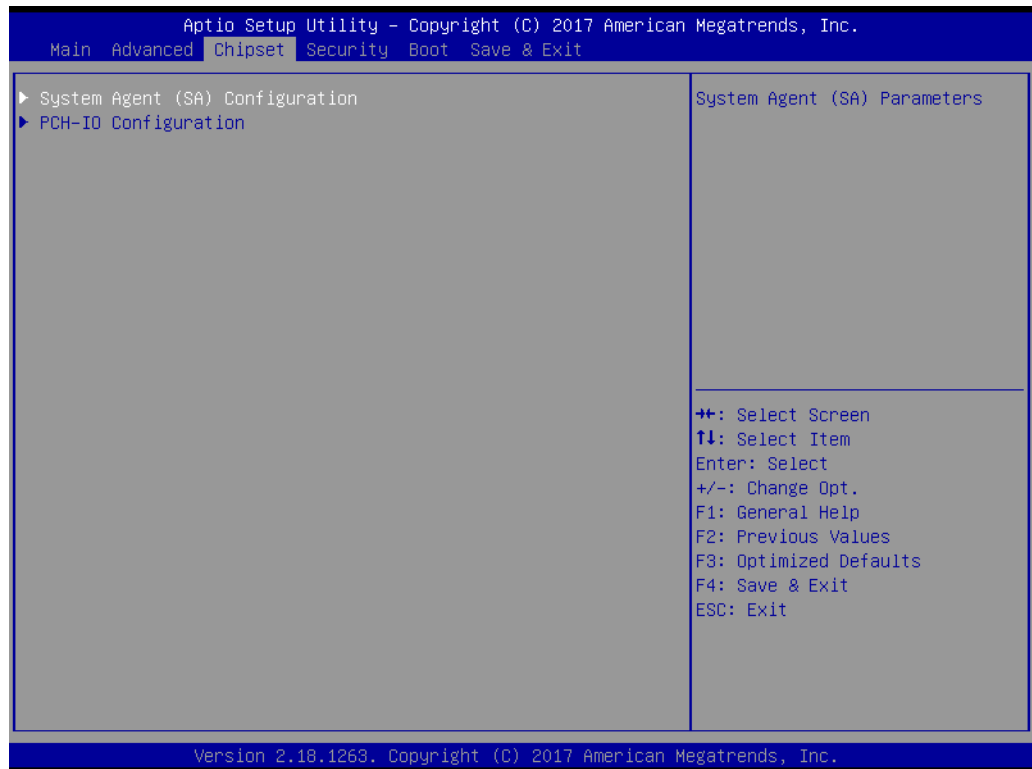

Figure 3.34 Chipset

#### 3.2.3.1 System Agent (SA) Configuration

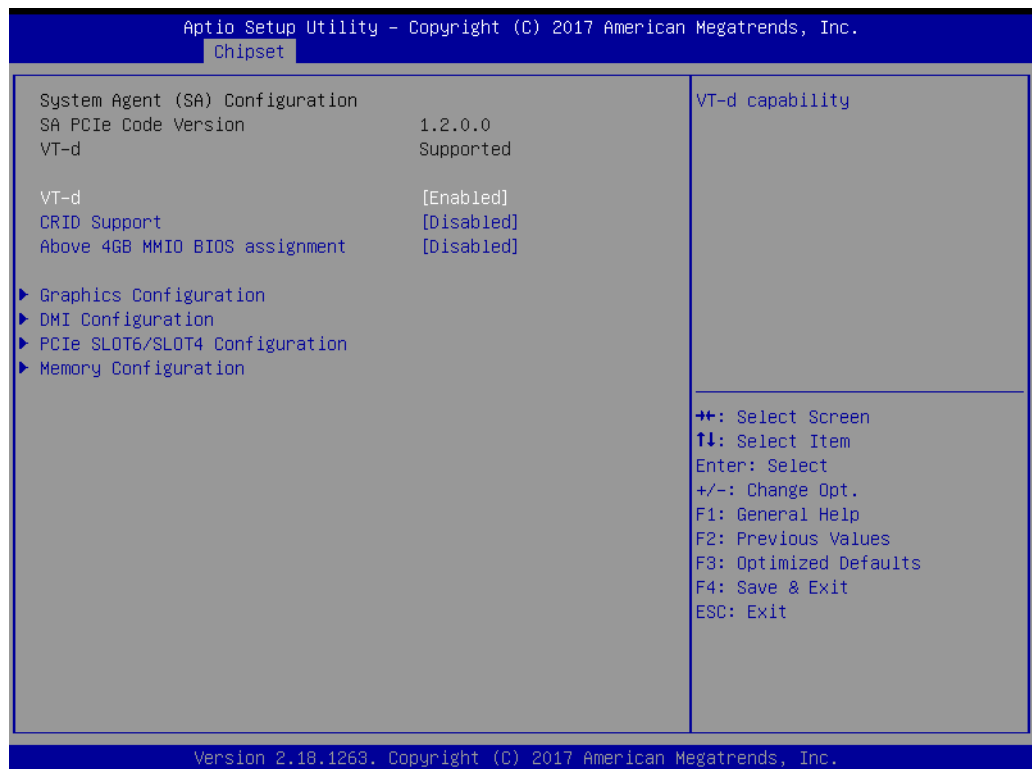
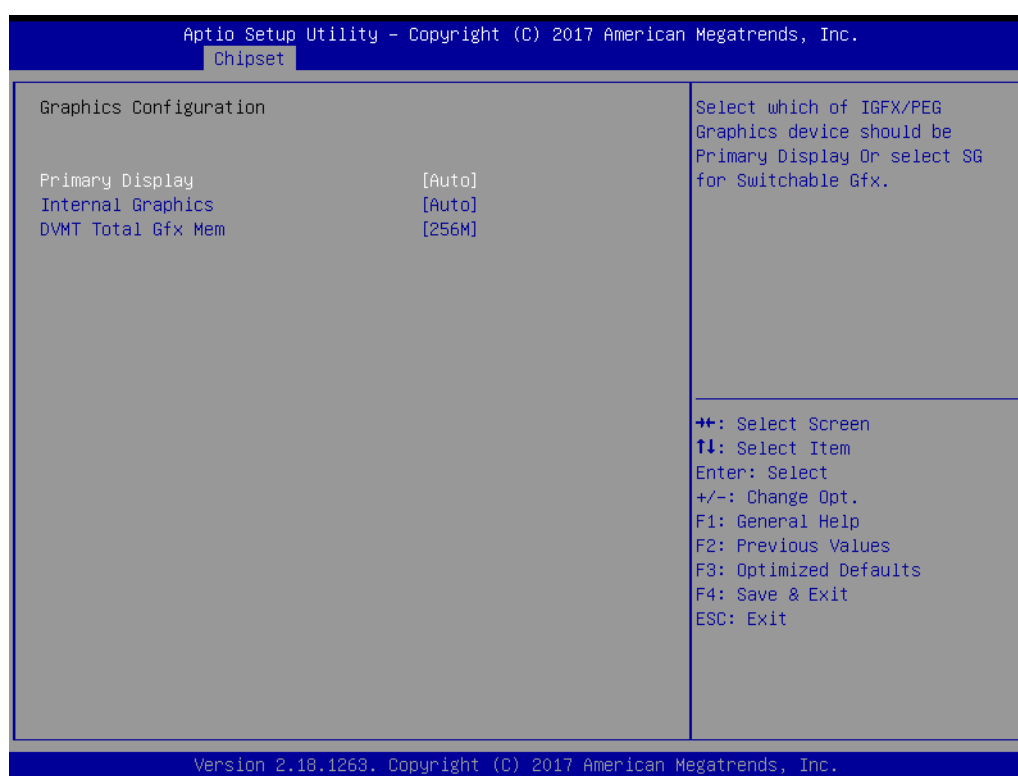

Figure 3.35 System Agent (SA) Configuration

- **VT-d**  
To enable or disable VT-d function on MCH.
- **CRID Support**  
Enable/Disable CRID control for Intel SIPP.
- **Above 4G MMIO BIOS assignment**  
Enable/Disable above 4GB Memory Mapped IO BIOS assignment.  
This is disabled automatically when Aperture Size is set to 2048MB

### 3.2.3.2 Graphics Configuration



**Figure 3.36 Graphics Configuration**

- **Primary Display**  
Select which of graphic device should be primary display or select SG for switchable Gfx.
- **Internal Graphics**  
To enable/disable/Auto internal graphics.
- **DVMT Total Gfx Mem**  
This item is to select DVMT5.0 Total Graphic Memory size used by the Internal Graphics Device.

### 3.2.3.3 DMI Configuration

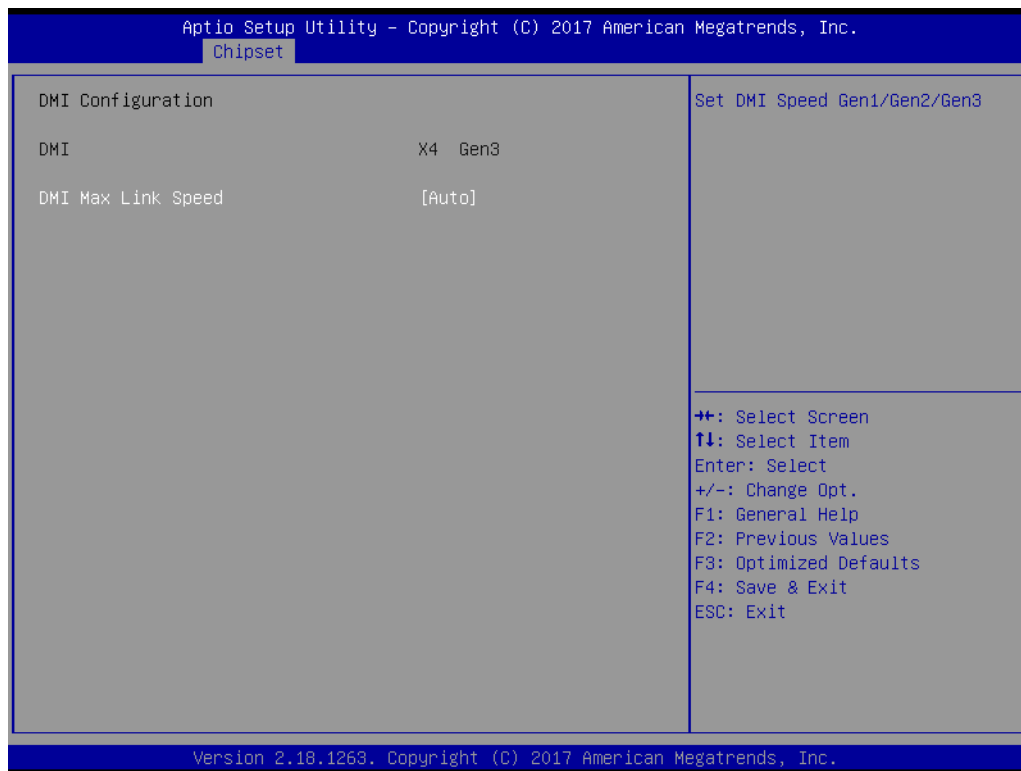

Figure 3.37 DMI Configuration

- **DMI Max Link Speed**  
Set DMI speed Auto/Gen1/Gen2/Gen3.

### 3.2.3.4 PCIe SLOT6/SLOT4 Configuration

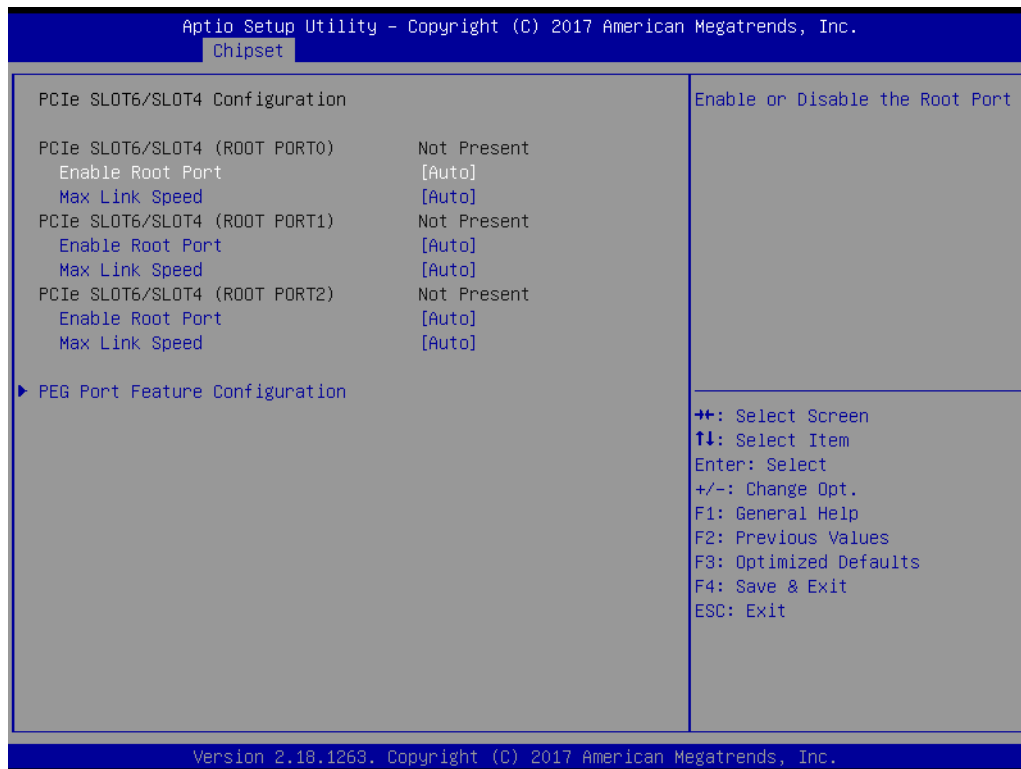
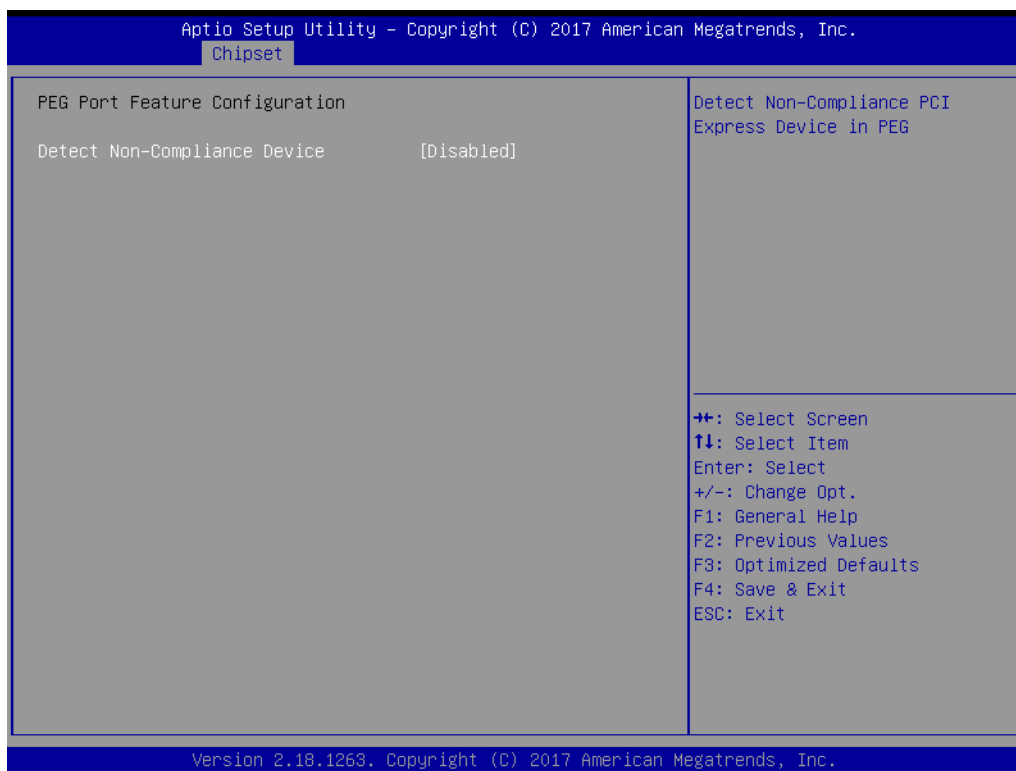

Figure 3.38 NB PCIe Configuration



- **PCIe SLOT6/SLOT4 (ROOT PORT0)**  
**Enable Root Port:**  
 Enable or Disable the Root Port.  
**Max Link Speed:**  
 Configure PEG 0:1:0 Max Speed.
- **PCIe SLOT6/SLOT4 (ROOT PORT1)**  
**Enable Root Port:**  
 Enable or Disable the Root Port.  
**Max Link Speed:**  
 Configure PEG 0:1:1 Max Speed.
- **PCIe SLOT6/SLOT4 (ROOT PORT2)**  
**Enable Root Port:**  
 Enable or Disable the Root Port.  
**Max Link Speed:**  
 Configure PEG 0:1:2 Max Speed.
- **PEG Port Feature Configuration**  
 Detect Non-Compliance PCI Express Device in PEG.



**Figure 3.39 PEG Port Feature Configuration**

### 3.2.3.5 Memory Configuration

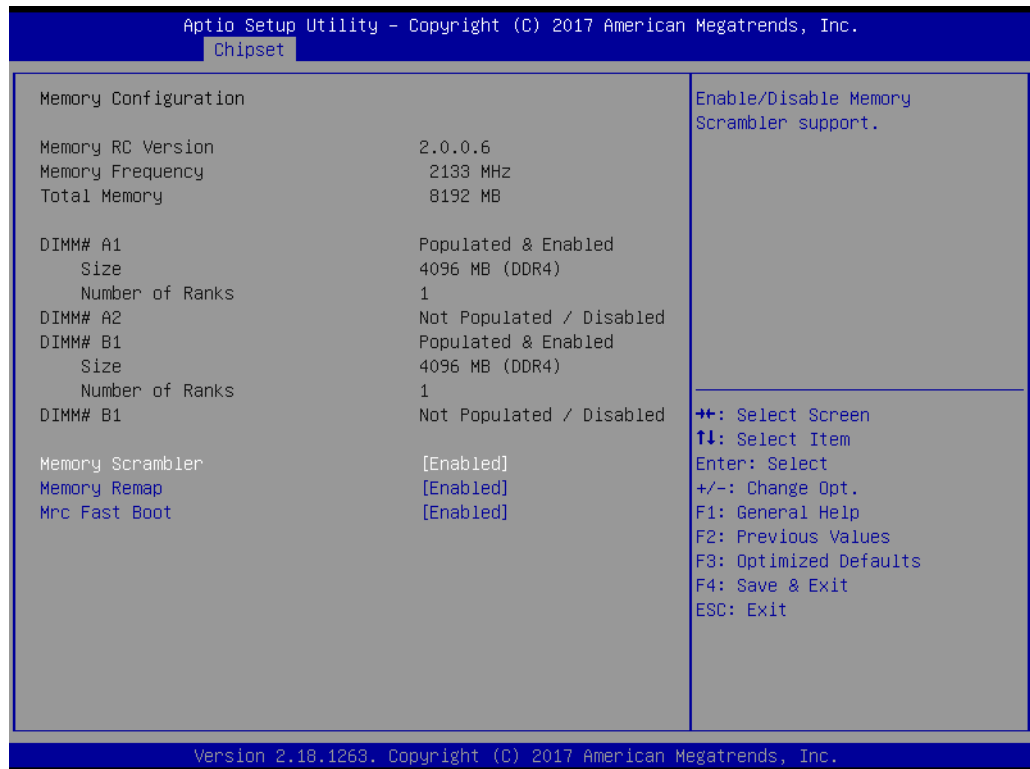

**Figure 3.40 Memory Configuration**

- **Memory Scrambler**  
Enable/Disable Memory Scrambler support.
- **Memory Remap**  
Enable/Disable Memory Remap above 4G.
- **Mrc Fast Boot**  
Enable/Disable fast path through the MRC.

### 3.2.3.6 PCH-IO Configuration

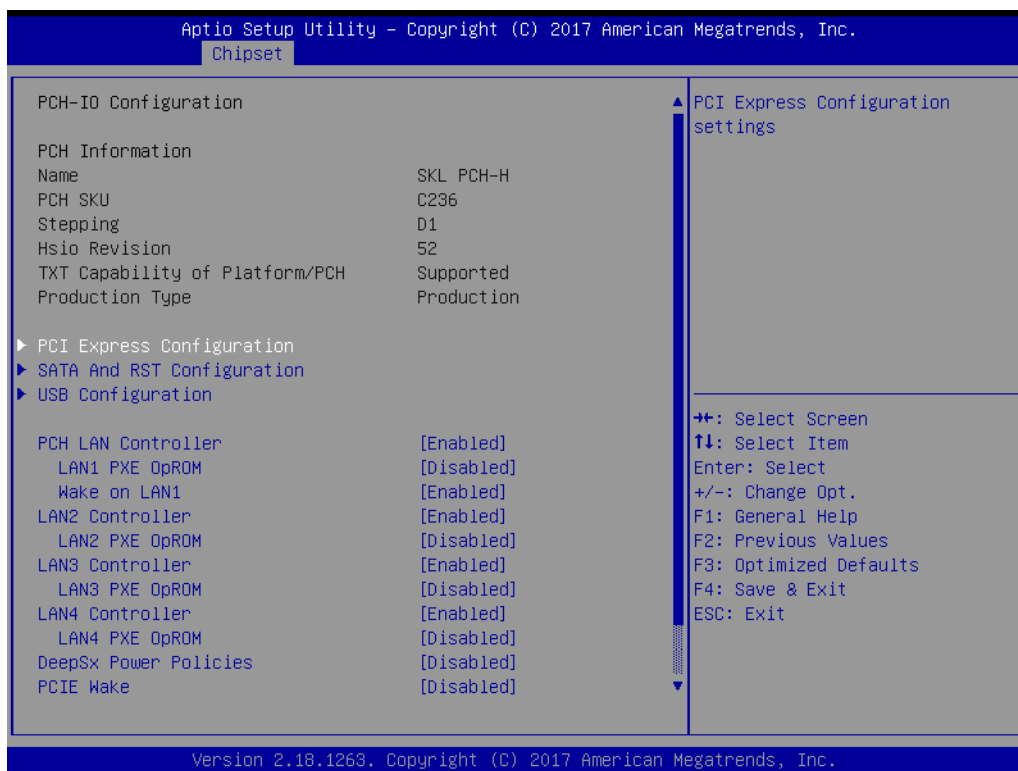
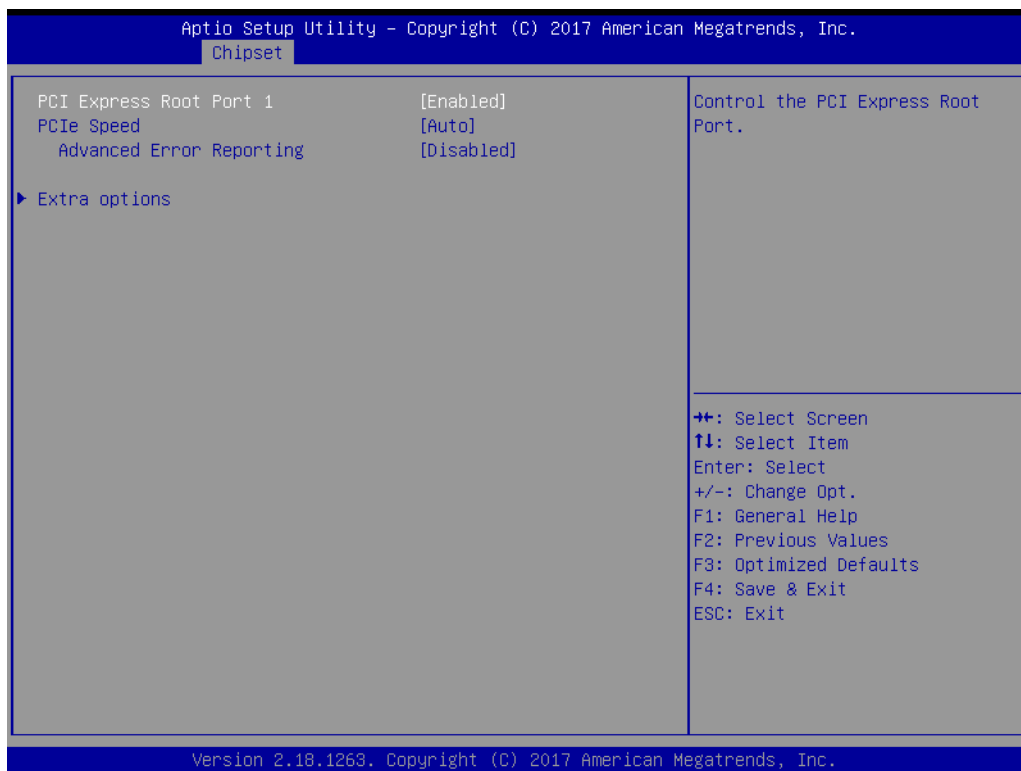

Figure 3.41 PCH-IO Configuration

- **PCH LAN Controller**  
Enable/Disable onboard LAN1
- **LAN1 PXE OpROM**  
Enable/Disable boot option for LAN1 controller
- **Wake on LAN1**  
Enable/Disable integrated LAN to wake the system
- **LAN2 Controller**  
Enable/Disable onboard LAN2
- **LAN2 PXE OpROM**  
Enable/Disable boot option for LAN2 controller
- **LAN3 Controller**  
Enable/Disable onboard LAN3
- **LAN3 PXE OpROM**  
Enable/Disable boot option for LAN3 controller
- **LAN4 Controller**  
Enable/Disable onboard LAN4
- **LAN4 PXE OpROM**  
Enable/Disable boot option for LAN4 controller
- **Deep Sx Power Policies**  
Enable or disable Deep Sx feature. When Deep Sx is enabled, most power including 5VSB will be off during Deep Sx for energy saving.
- **PCIE Wake**  
To enable or disable PCIE to wake the system from S5.
- **Serial IRQ Mode**





**Figure 3.43 PCI Express Slot 2 Configuration**

- **PCI Express Root Port 1 (PCIE SLOT2)**  
Control the PCI Express Root Port.
- **PCIe Speed**  
To set PCIe speed for PCI Express Slot 2.
- **Advanced Error Reporting**  
Enable/Disable advanced error reporting.
- **Extra Options**  
PCI Express Root Port extra options

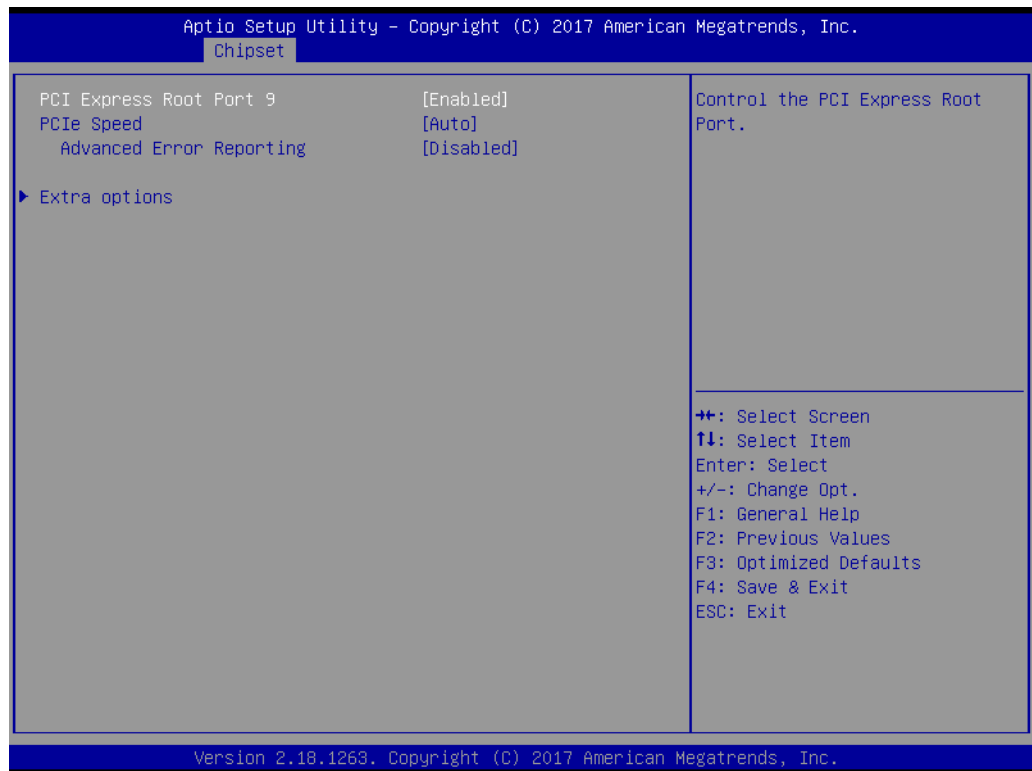
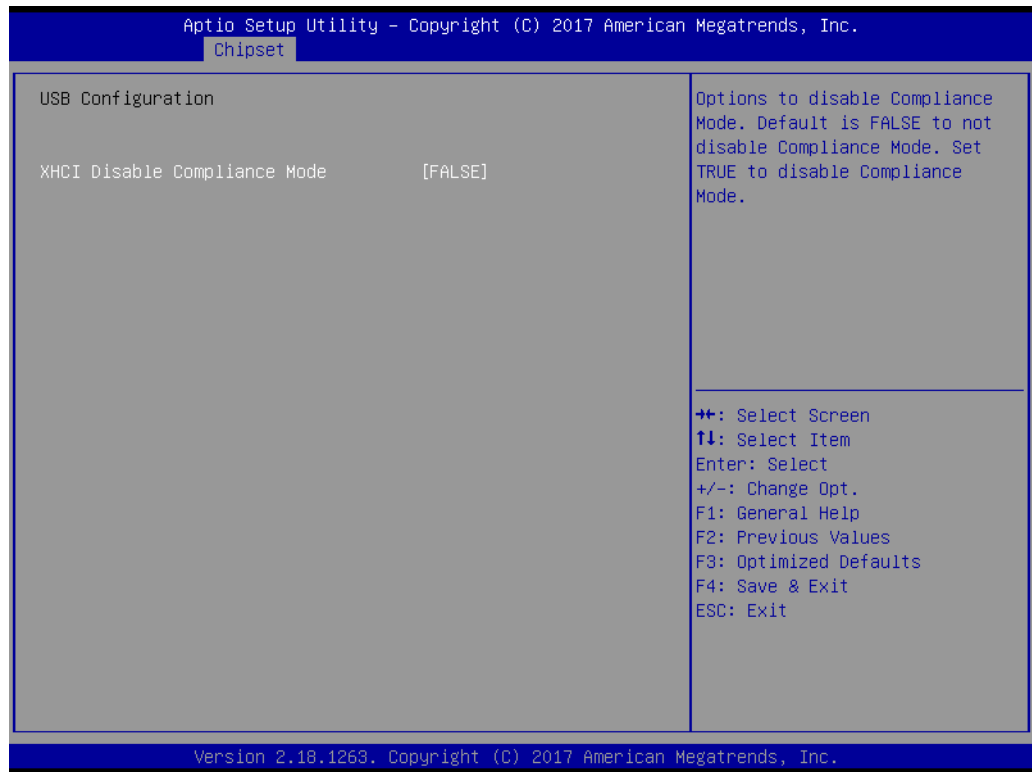

**Figure 3.44 PCI Express Slot 7 Configuration**

- **PCI Express Root Port 9 (PCIE SLOT7)**  
Control the PCI Express Root Port.
- **PCIe Speed**  
To set PCIe speed for PCI Express Slot 7.
- **Advanced Error Reporting**  
Enable/Disable advanced error reporting
- **Extra Opions**  
PCI Express Root Port extra options



### 3.2.3.9 USB Configuration

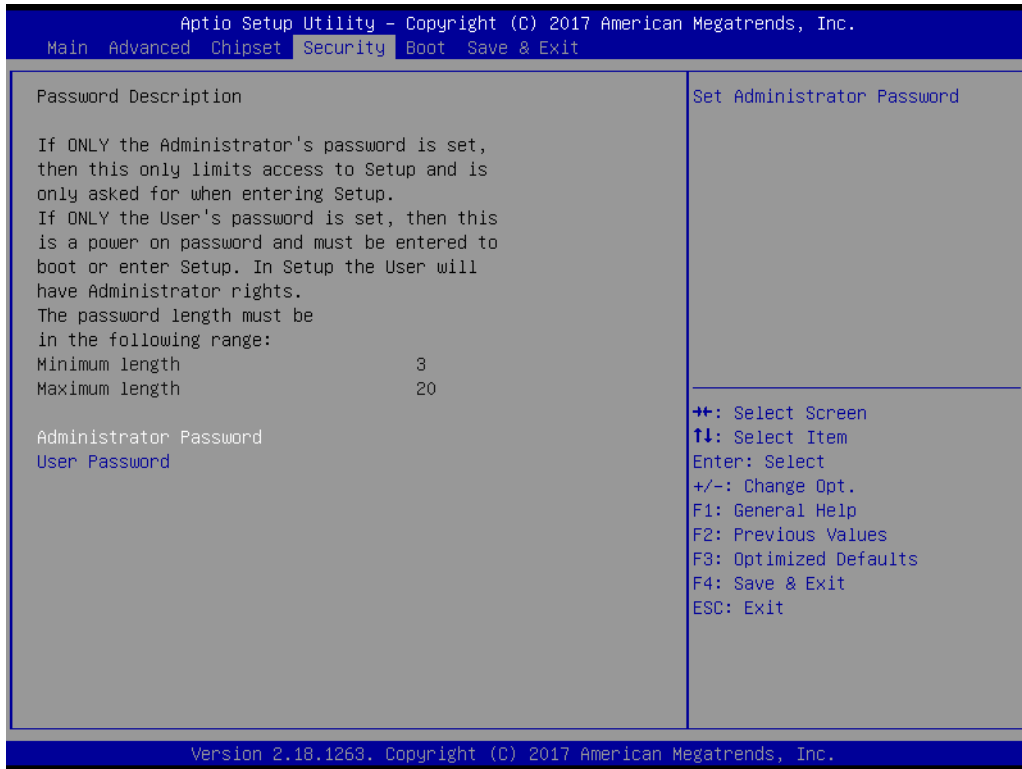

**Figure 3.46 USB Configuration**

- **XHCI Disable Compliance Mode**  
Options to disable Compliance Mode Default is FALSE to not disable Compliance Mode.  
Set TRUE to disable Compliance Mode.



### 3.2.4 Security



**Figure 3.47 Security**

Select Security Setup from the ASMB-785 Setup main BIOS setup menu. All Security Setup options, such as password protection, are described in this section. To access the sub menu for the following items, select the item and press <Enter>.

## 3.2.5 Boot

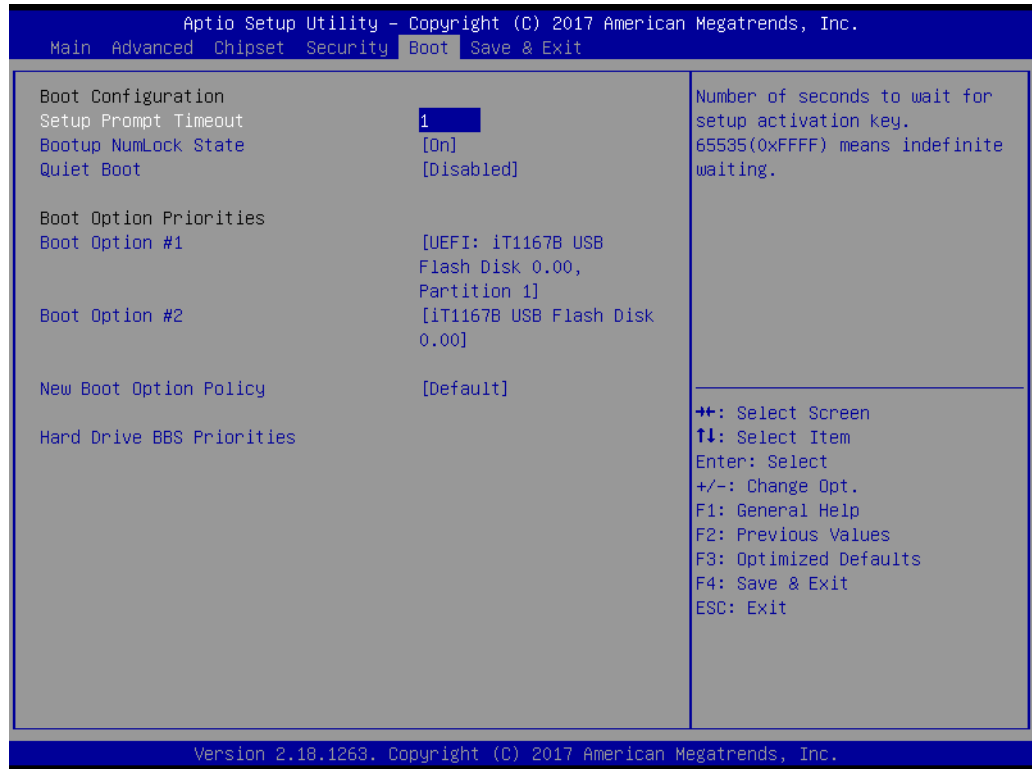
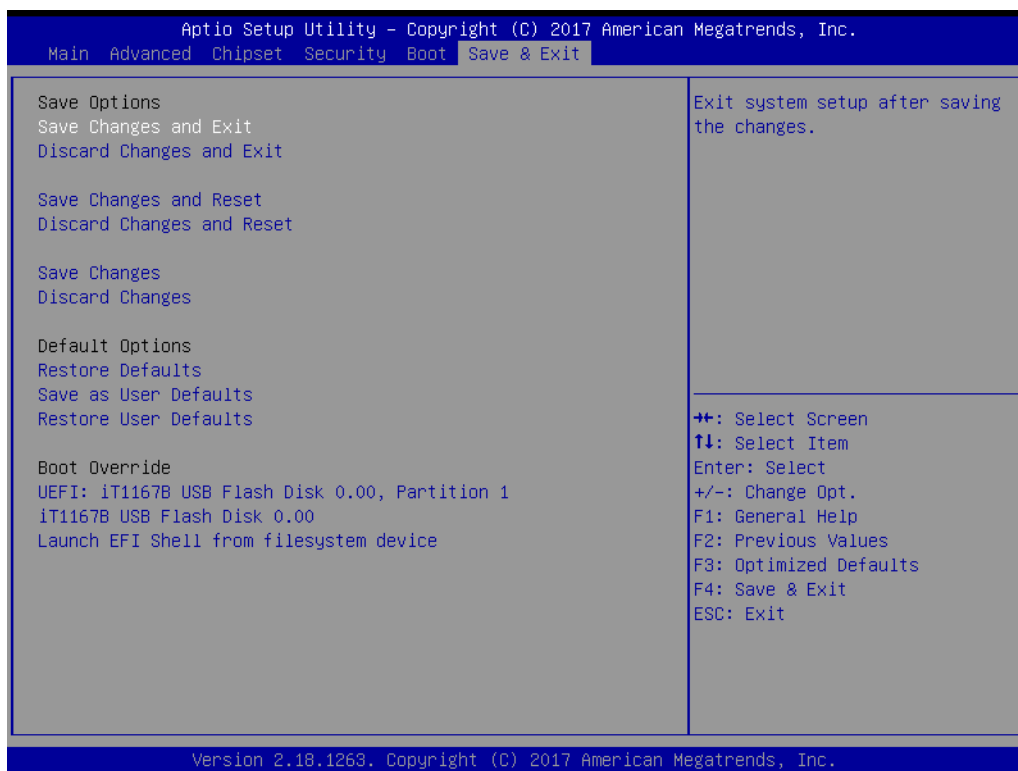

Figure 3.48 Boot

- **Setup Prompt Timeout**  
Use the <+> and <-> keys to adjust the number of seconds to wait for setup activation key.
- **Bootup NumLock State**  
“On” or “Off” power-on state for the NumLock.
- **Quiet Boot**  
If this option is set to Disabled, the BIOS displays normal POST messages. If Enabled, an OEM Logo is shown instead of POST messages.
- **Boot Option Priorities**
- **New Boot Option Policy**  
Controls the placement of newly detected UEFI boot options.

### 3.2.6 Save & Exit



**Figure 3.49 Save & Exit**

- **Save Changes and Exit\***  
When you have completed system configuration, select this option to save your changes, exit BIOS setup and boot into the OS so the new system configuration parameters can take effect.
- **Discard Changes and Exit**  
Select this option to quit setup without making any permanent changes to the system configuration.
- **Save Changes and Reset**  
When you have completed system configuration, select this option to save your changes, exit BIOS setup and reboot into the computer so the new system configuration parameters can take effect.
- **Discard Changes and Reset**  
Select this option to quit Setup and reset computer without making any permanent changes to the system configuration.
- **Save Changes**  
Select this option to save your changes.
- **Discard Changes**  
Select this option to discard your changes.
- **Restore Defaults**  
Select this option to restore BIOS configuration as origin.
- **Save as User Defaults**  
Select this option to save user's configuration.
- **Restore User Defaults**  
Select this option to restore BIOS to user's configuration.

---

- **Launch EFI Shell from file system device**

This option allows you to attempt to launch the EFI Shell application (shellx64.efi) from one of the available file system devices.

\*When you make some critical changes, the system will still reboot even you choose "Save changes and exit".

# Chapter 4

Chipset Software  
Installation Utility

## 4.1 Before You Begin

To facilitate the installation of the enhanced display drivers and utility software, read the instructions in this chapter carefully. The drivers for the ASMB-785 are located on the software installation DVD.

**Note!** *The files on the software installation DVD are compressed. Do not attempt to install the drivers by copying the files manually. You must use the supplied SETUP program to install the drivers.*



Before you begin, it is important to note that most display drivers need to have the relevant software application already installed in the system prior to installing the enhanced display drivers. In addition, many of the installation procedures assume that you are familiar with both the relevant software applications and operating system commands. Review the relevant operating system commands and the pertinent sections of your application software's user manual before performing the installation.

## 4.2 Introduction

The Intel® Chipset Software Installation (CSI) utility installs the Windows INF files that outline to the operating system how the chipset components will be configured. This is needed for the proper functioning of the following features:

- Serial ATA interface support
- USB 1.1/2.0/3.0 support
- Identification of Intel chipset components in the Device Manager

**Note!** *The chipset driver is used for the following versions of Windows, and it has to be installed before installing all the other drivers:*



- Windows® server 2008 R2 (64-bit)
- Windows® server 2012 R2 (64-bit)
- Windows® server 2016 (64-bit)
- Windows® 7 (32-bit)
- Windows® 7 (64-bit)
- Windows® 8.1 (32-bit)
- Windows® 8.1 (64-bit)
- Windows® 10 (64-bit)

## 4.3 Windows OS Driver Setup

Insert the driver DVD into your system's DVD-ROM drive. You can see the driver folders items. Move the mouse cursor over the folder "01-Chipset". In CSI folder, you can click find an executable file to complete implementation of the driver.

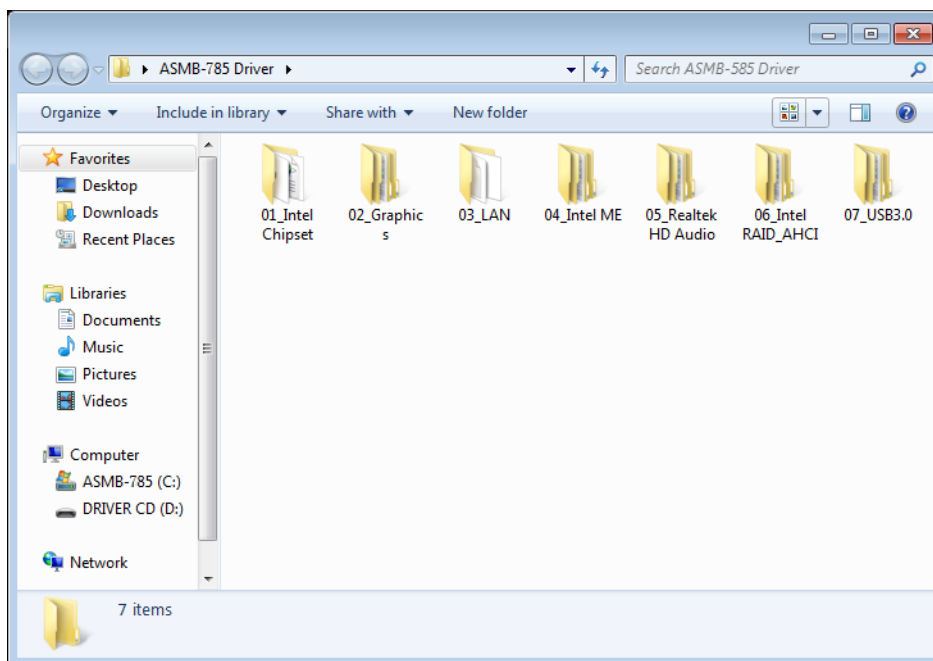





# Chapter 5

## VGA Setup

## 5.1 Introduction

The Intel® Xeon® E3-1200 v5/v6 and 6th/7th Gen. Core™ i3/i5/i7 series processors are embedded with an integrated graphics controller. You need to install the VGA driver to enable this function, which includes the following features:

- Optimized integrated graphic solution: With Intel® Graphics Flexible Display Interface, it supports versatile display options and 32-bit 3D graphics engine. Dual independent display, enhanced display modes for widescreen flat panels for extend, twin, and clone dual display modes. Optimized 3D support delivers an intensive and realistic visual experience.

## 5.2 Windows OS Driver Setup

**Note!** Before installing this driver, make sure the INF driver has been installed in your system. See Chapter 4 for information on installing the INF driver.



Insert the driver DVD into your system's DVD-ROM drive. You can see the driver folders items. Navigate to the "02 Graphics" folder and click the executable file to complete the installation of the drivers for Windows® OS.

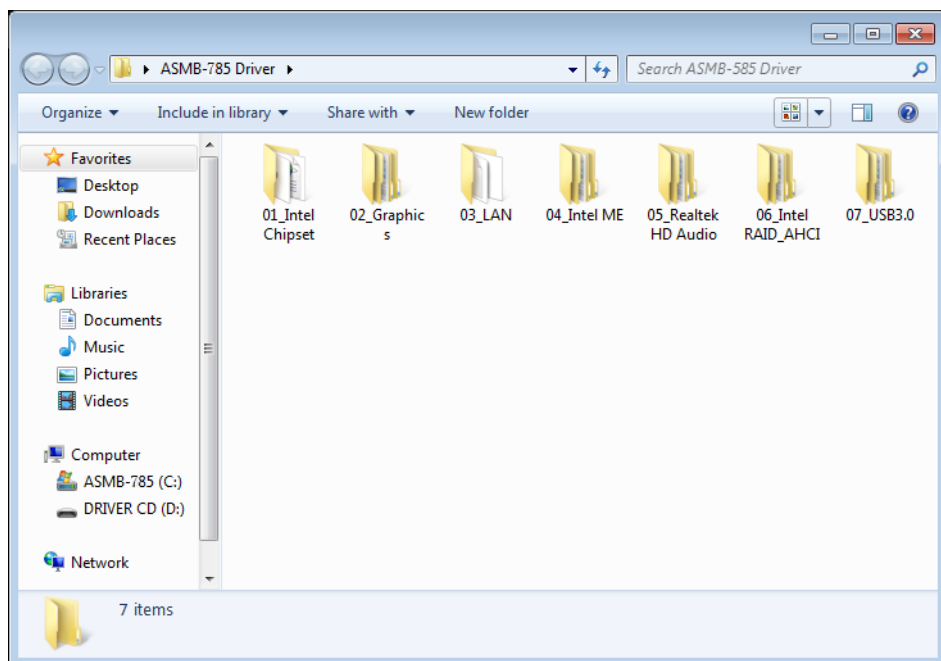

# Chapter 6

## LAN Configuration

## 6.1 Introduction

The ASMB-785 is equipped up to two or four Gigabit Ethernet LANs via dedicated PCI Express x1 lanes (GbE LAN1: Intel® I219LM; GbE LAN2~4: Intel® I210-AT that offer bandwidth of up to 500 MB/sec, eliminating the bottleneck of network data flow and incorporating Gigabit Ethernet at 1000 Mbps.

## 6.2 Features

- 10/100/1000 Mbps Ethernet controller
- 10/100/1000 Mbps triple-speed MAC
- Full duplex at 10, 100, or 1000 Mbps and half duplex at 10 or 100 Mbps
- Wake-on-LAN (WOL) support
- PCIe x1 host interface

## 6.3 Installation

**Note!** Before installing the LAN drivers, make sure the CSI utility has been installed on your system. See Chapter 4 for information on installing the CSI utility.



The integrated Intel® gigabit Ethernet controller supports all major network operating systems. However, the installation procedure varies with different operating systems. In the following sections, refer to the one that provides the driver setup procedure for the operating system you are using.

## 6.4 Windows OS Driver Setup (LAN)

Insert the driver DVD into your system's DVD-ROM drive. Select folder "03-LAN" then click the proper LAN driver for the OS.

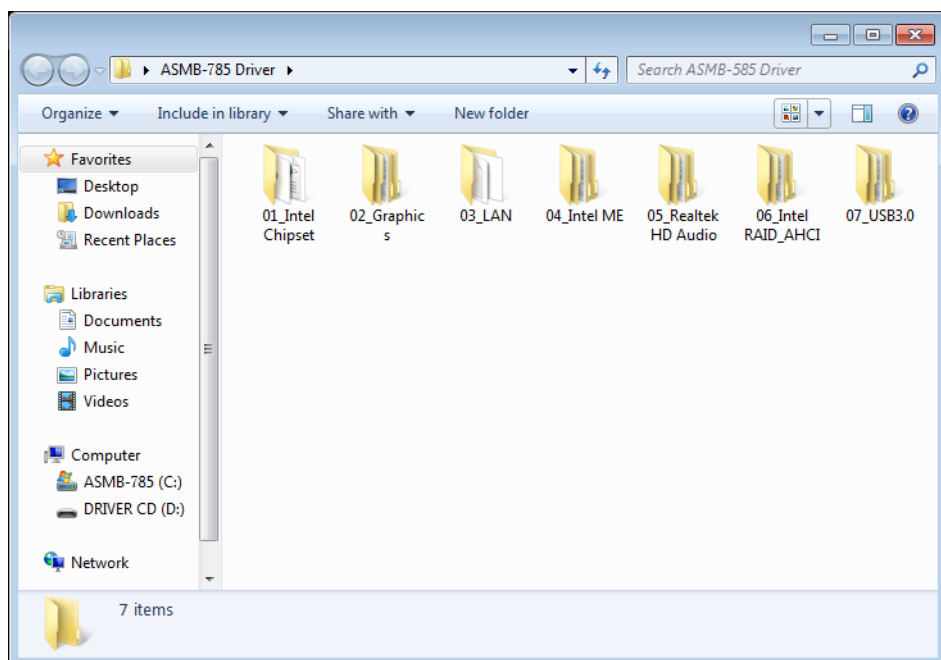

# Chapter 7

Intel ME

## 7.1 Introduction

The Intel ME software components that need to be installed depend on the system's specific hardware and firmware features. The installer detects the system's capabilities and installs the relevant drivers and applications.

## 7.2 Installation

Insert the driver DVD into your system's DVD-ROM drive. Navigate to the "04\_Intel ME" folder to install the driver.

**Note!** *If the Intel® Management Engine (Xeon® ME) driver has not been successfully installed, you may see an error on a "PCI Simple Communications Controller" in Device Manager.*



*If you use Win7 OS and there is a problem with ME installing, please find the folder "ME update kit for Win7" to fix it.*

The integrated Intel® gigabit Ethernet controller supports all major network operating systems. However, the installation procedure varies with different operating systems. In the following sections, refer to the one that provides the driver setup procedure for the operating system you are using.

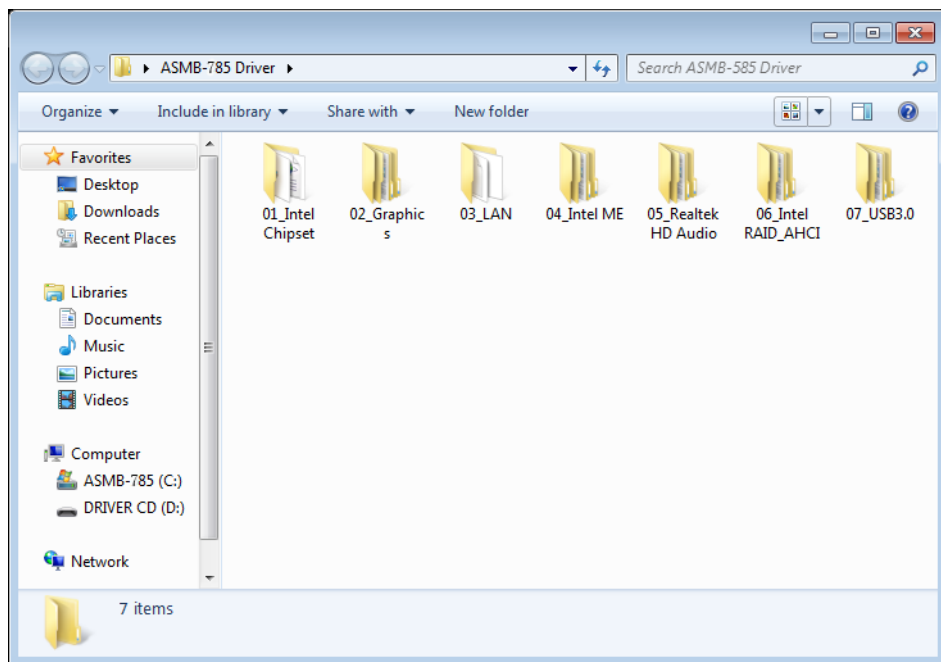

# Chapter 8

Intel USB 3.0

## 8.1 Introduction

ASMB-785 provides Intel® USB 3.0 and the data transfer rate of USB3.0 (5Gbps) is 10 times to USB2.0 (480Mbps).

## 8.2 Installation

Insert the driver DVD into your system's DVD-ROM drive. Navigate to the "07\_USB3.0" folder to install the driver.

**Note!** *The Intel® USB 3.0 eXtensible Host Controller Driver is not supported on Windows\* XP and Windows\* Vista. For these operating systems, ensure your BIOS settings have the xHCI Mode set to "Auto" or "Smart Auto". This will reconfigure the USB 3.0 ports to function as USB 2.0 ports using the native Windows\* EHCI driver.*

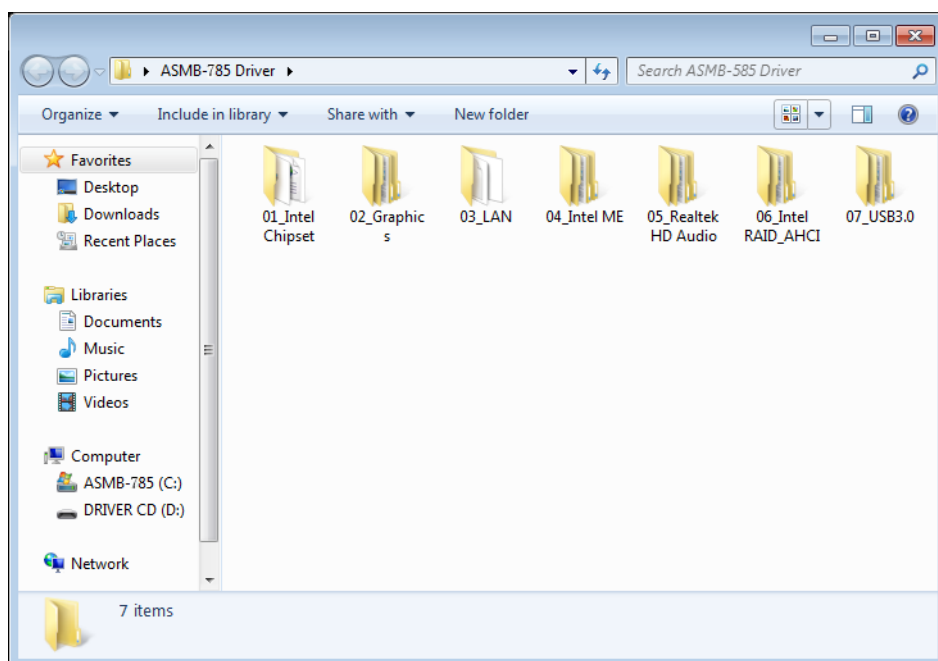



# Chapter 9

## SATA RAID Setup

## 9.1 Introduction

To support demanding disk I/O, Intel® C236 chipset integrates seven Serial ATA controllers with software RAID 0, 1, 5, 10 capabilities.

RAID 0 striping increases the storage performance and is designed to speed up data transfer rates for disk-intensive applications.

RAID 1 mirroring protects valuable data that might be lost in the event of a hard drive failure.

RAID 5 array contains three or more hard drives where the data is divided into manageable blocks called strips. Parity is a mathematical method for recreating data that was lost from a single drive, which increases fault-tolerance. The data and parity are striped across all the hard drives in the array. The parity is striped in a rotating sequence to reduce bottlenecks associated with the parity calculations.

RAID 10 array uses four hard drives to create a combination of RAID levels 0 and 1. The data is striped across a two-drive array forming the RAID 0 component. Each of the drives in the RAID 0 array is then mirrored by a RAID 1 component.

## 9.2 SATA RAID Driver and Utility Setup

The driver is in the DVD "06\_Intel RAID\_AHCI" folder. You may go to the directory of the DVD and follow Intel's installation guide to install the driver and utility.

**Note!** For the detailed installation instructions for the SATA RAID driver and utility, please check the User Guide in the driver CD. Path: folder "Intel Rapid Storage Technology" in "06\_Intel RAID\_AHCI".



**Note!** Before you install the Intel® Rapid Storage Technology, please read the "readme.txt" which is in the folder "Intel Rapid Storage Technology" in "06\_Intel RAID\_AHCI".

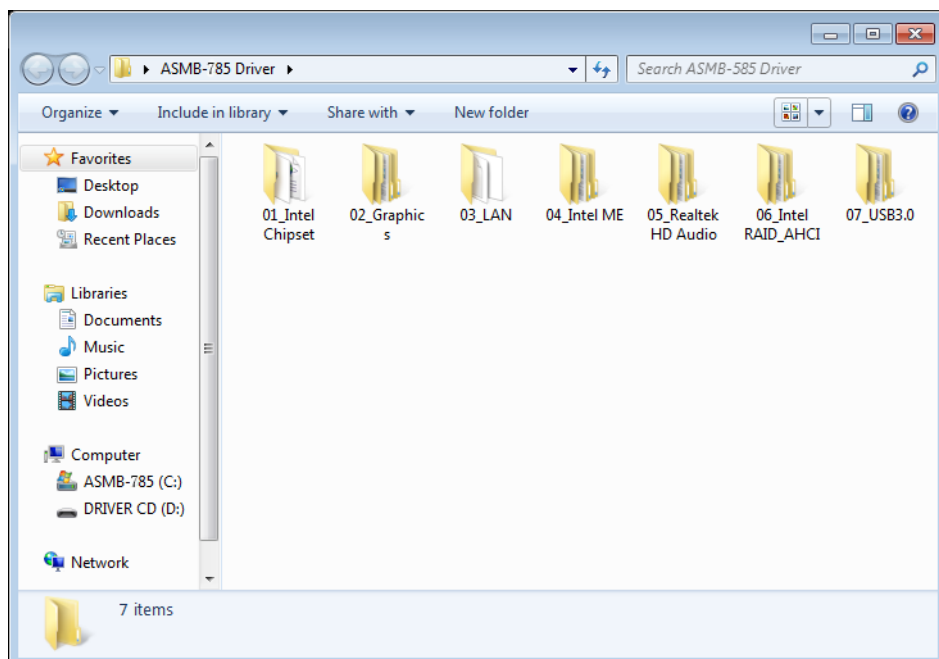

# Chapter 10

HD Audio

## 10.1 Introduction

ASMB-785 equipped with Realtek ALC892 Audio chip. It provides "Line-out" & "Microphone" two ports for any related applications.

## 10.2 Installation

The driver is in the DVD's "05\_Realtek HD Audio" folder. You may go to the directory of the DVD and follow the installation guide to install the driver and utility.

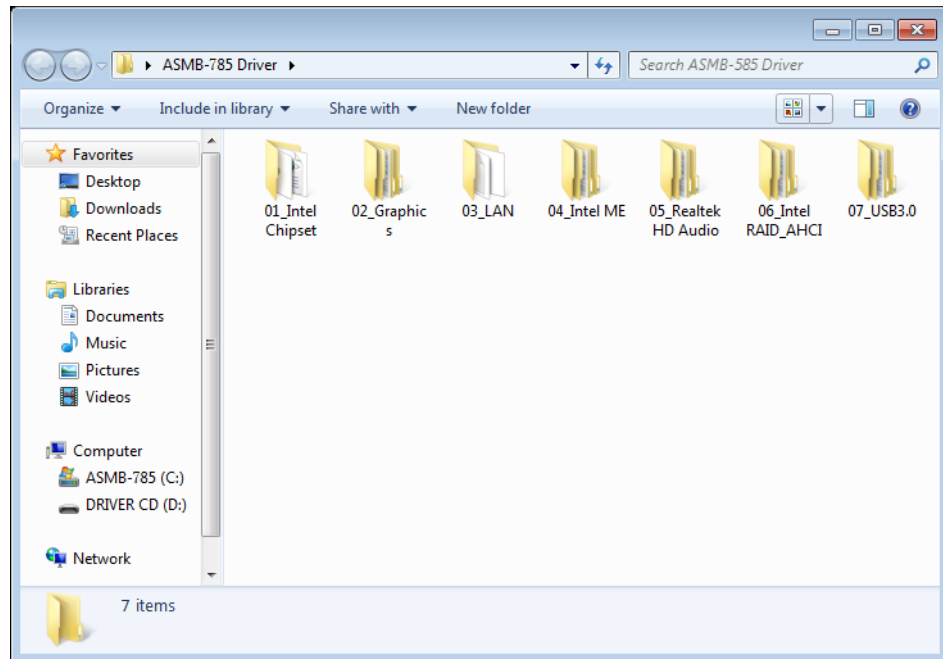

# Appendix **A**

Programming the  
Watchdog Timer

---

The ASMB-785's watchdog timer can be used to monitor system software operation and take corrective action if the software fails to function within the programmed period. This section describes the operation of the watchdog timer and how to program it.

## A.1 Watchdog timer overview

The watchdog timer is built in to the super I/O controller NCT6776D. It provides the following functions for user programming:

- Can be enabled and disabled by the user's program
- Timer can be set from 1 to 255 seconds
- Generates an interrupt or resets signal if the software fails to reset the timer before time-out

## A.2 Programming the Watchdog Timer

The I/O port address of the watchdog timer is 2E (hex) and 2F (hex). 2E (hex) is the address port. 2F (hex) is the data port. You must first write an address value into address port 2E (hex), and then write/read data to/from the assigned register through data port 2F (hex).

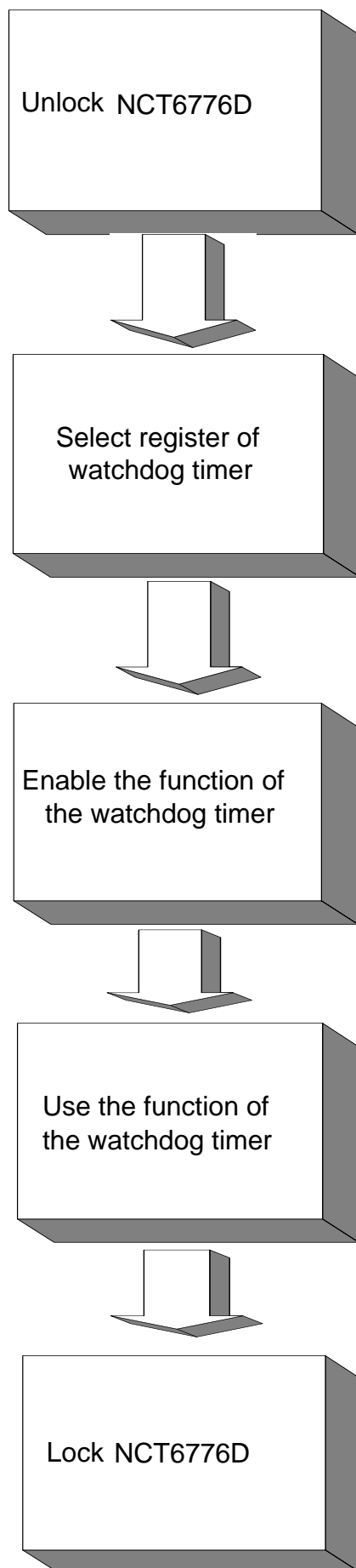

**Table A.1: Watchdog timer registers**

Address of register (2E)	Read/Write	Value (2F) & description
87 (hex)	-	Write this address to I/O address port 2E (hex) twice to unlock the NCT6776D
07 (hex)	write	Write 08 (hex) to select register of watchdog timer.
30 (hex)	write	Write 01 (hex) to enable the function of the watchdog timer. Disabled is set as default.
F5 (hex)	write	Set seconds or minutes as units for the timer. Write 0 to bit 3: set seconds as counting unit. [default]. Write 1 to bit 3: set minutes as counting unit. Write 1 to bit 4: Watchdog timer count mode is 1000 times faster. If bit 3 is 0, the count mode is 1/1000 seconds mode. If bit 3 is 1, the count mode is 1/1000 minutes mode.
F6 (hex)	write	0: stop timer [default] 01 ~ FF (hex): The amount of the count, in seconds or minutes, depends on the value set in register F5 (hex). This number decides how long the watchdog timer waits for strobe before generating an interrupt or reset signal. Writing a new value to this register can reset the timer to count with the new value.
F7 (hex)	read/write	Bit 6: Write 1 to enable keyboard to reset the timer, 0 to disable.[default] Bit 5: Write 1 to generate a timeout signal immediately and automatically return to 0. [default=0] Bit 4: Read status of watchdog timer, 1 means timer is "timeout".
AA (hex)	-	Write this address to I/O port 2E (hex) to lock NCT6776D.

## A.2.1 Example Programs

### Enable watchdog timer and set 10 seconds as the timeout interval

```

;-----
Mov dx,2eh ; Unlock NCT6776D
Mov al,87h
Out dx,al
Out dx,al
;-----
Mov al,07h ; Select registers of watchdog timer
Out dx,al
Inc dx
in al,dx
Or al,08h
Out dx,al
;-----
Dec dx; Enable the function of watchdog timer
Mov al,30h
Out dx,al
Inc dx
Mov al,01h
Out dx,al
;-----

```



```

Dec dx ; Set second as counting unit
Mov al,0f5h
Out dx,al
Inc dx
In al,dx
And al,not 08h
Out dx,al
;-----
Dec dx ; Set timeout interval as 10 seconds and start counting
Mov al,0f6h
Out dx,al
Inc dx
Mov al,10; 10 minutes
Out dx,al
;-----
Dec dx ; lock NCT6776D
Mov al,0aah
Out dx,al
Enable watchdog timer and set 5 minutes as the timeout interval
;-----
Mov dx,2eh ; unlock NCT6776D
Mov al,87h
Out dx,al
Out dx,al
;-----
Mov al,07h ; Select registers of watchdog timer
Out dx,al
Inc dx
In al,dx
Or al,08h
Out dx,al
;-----
Dec dx ; Enable the function of watchdog timer
Mov al,30h
Out dx,al
Inc dx
Mov al,01h
Out dx,al
;-----
Dec dx ; Set minute as counting unit
Mov al,0f5h
Out dx, al
Inc dx
In al,dx
Or al, 08h

```

```

Out dx,al
;-----
Dec dx ; Set timeout interval as 5 minutes and start counting
Mov al,0f6h
Out dx,al
Inc dx
Mov al,5; 5 minutes
Out dx,al
;-----
Dec dx ; lock NCT6776D
Mov al,0aah
Out dx,al
Enable watchdog timer to be reset by mouse
;-----
Mov dx,2eh ; unlock NCT6776D
Mov al,87h
Out dx,al
Out dx,al
;-----
Mov al,07h ; Select registers of watchdog timer
Out dx,al
Inc dx
Mov al,08h
Out dx,al
;-----
Dec dx ; Enable the function of watchdog timer
Mov al,30h
Out dx,al
Inc dx
In al,dx
Or al,01h
Out dx,al
;-----
Dec dx ; Enable watchdog timer to be reset by mouse
Mov al,0f7h
Out dx,al
Inc dx
In al,dx
Or al,80h
Out dx,al
;-----
Dec dx ; lock NCT6776D
Mov al,0aah
Out dx,al
Enable watchdog timer to be reset by keyboard

```

```

;-----
Mov dx,2eh ; unlock NCT6776D
Mov al,87h
Out dx,al
Out dx,al
;-----
Mov al,07h ; Select registers of watchdog timer
Out dx,al
Inc dx
Mov al,08h
Out dx,al
;-----
Dec dx ; Enable the function of watchdog timer
Mov al,30h
Out dx,al
Inc dx
Mov al,01h
Out dx,al
;-----
Dec dx ; Enable watchdog timer to be strobed reset by keyboard
Mov al,0f7h
Out dx,al
Inc dx
In al,dx
Or al,40h
Out dx,al
;-----
Dec dx ; lock NCT6776D
Mov al,0aah
Out dx,al
Generate a time-out signal without timer counting
;-----
Mov dx,2eh ; unlock NCT6776D
Mov al,87h
Out dx,al
Out dx,al
;-----
Mov al,07h ; Select registers of watchdog timer
Out dx,al
Inc dx
Mov al,08h
Out dx,al
;-----
Dec dx ; Enable the function of watchdog timer
Mov al,30h

```

---

```
Out dx,al
Inc dx
In al,dx
Or al,01h
Out dx,al
;-----
Dec dx ; Generate a time-out signal
Mov al,0f7h
Out dx,al ;Write 1 to bit 5 of F7 register
Inc dx
In al,dx
Or al,20h
Out dx,al
;-----
Dec dx ; lock NCT6776D
Mov al,0aah
Out dx,al
```

# Appendix **B**

I/O Pin Assignments

## B.1 USB2.0 Header (USB7~12)

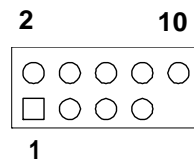

**Table B.1: USB Header (USB6~11)**

Pin	Signal	Pin	Signal
1	USB_VCC5	2	USB_VCC5
3	USB_D-	4	USB_D-
5	USB_D+	6	USB_D+
7	GND	8	GND
9	Key	10	N/C

## B.2 USB3.0 Header (USB3\_4)

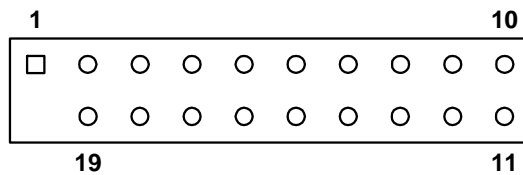

**Table B.2: USB 3.0 Header (USB3\_4)**

Pin	Signal	Pin	Signal
1	+5V_USB2_3	20	NC
2	USB3_RX_DN5	19	+5V_USB2_3
3	USB3_RX_DP5	18	USB3_RX_DN6
4	GND	17	USB3_RX_DP6
5	USB3_TX_DN5	16	GND
6	USB3_TX_DP5	15	USB3_TX_DN6
7	GND	14	USB3_TX_DP6
8	USB2_N2	13	GND
9	USB2_P2	12	USB2_N3
10	USB_OC	11	USB2_P3

## B.3 VGA Connector (VGA)

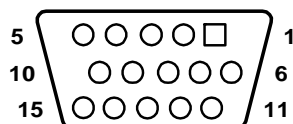

**Table B.3: VGA Connector (VGA)**

Pin	Signal	Pin	Signal
1	RED	9	VCC
2	GREEN	10	GND
3	BLUE	11	N/C
4	N/C	12	SDT
5	GND	13	H-SYNC
6	GND	14	V-SYNC
7	GND	15	SCK
8	GND		

## B.4 RS-232 Interface (COM2)

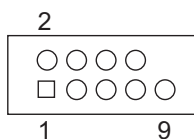

**Table B.4: RS-232 Interface (COM2)**

COM1/COM2	
Pin	Signal
1	DCD
2	DSR
3	RXD
4	RTS
5	TXD
6	CTS
7	DTR
8	RI
9	GND

## B.5 External Keyboard and Mouse Connector (KBMS1)

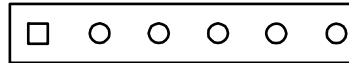

**Table B.5: External Keyboard and Mouse Connector (KBMS1)**

Pin	Signal
1	KB CLK
2	KB DATA
3	MS DATA
4	GND
5	VCC
6	MS CLK

## B.6 System Fan Power Connector (SYSFAN0~3)

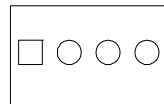

**Table B.6: Fan Power Connector**

Pin	Signal
1	GND
2	+12 V
3	DETECT
4	PWM

## B.7 Power LED and Keyboard Lock (JFP3)

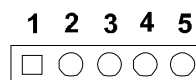
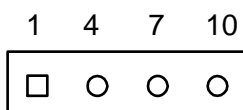

**Table B.7: Power LED and Keyboard Lock (JFP3)**

Pin	Function
1	LED power + (3.3 V)
2	NC
3	LED power -
4	#keylock
5	Ground



## B.8 External Speaker Connector (JFP2)



**Table B.8: External Speaker Connector (JFP2)**

Pin	Function
1	SPK_VCC
4	SPK_OBS
7	SPK_BUZ
10	SPK_OUT

## B.9 HDD LED Connector (JFP2)

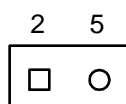

**Table B.9: HDD LED Connector (JFP2)**

Pin	Signal
2	HDD_LED+
5	HDD_LED-

## B.10 SNMP SMBus Connector (JFP2)

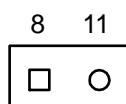

**Table B.10: SNMP SMBus Connector (JFP2)**

Pin	Signal
8	HWM_SDA
11	HWM_SCL

## B.11 ATX Soft Power Switch (JFP1)

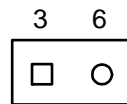

**Table B.11: ATX Soft Power Switch (JFP1)**

Pin	Signal
3	PWR-BTN
6	GND

## B.12 Reset Connector (JFP1)

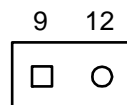

**Table B.12: Reset Connector (JFP1)**

Pin	Signal
9	RESET
12	GND

## B.13 USB/LAN ports (LAN1\_USB1\_2 and LAN2\_USB5\_6)

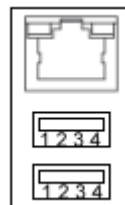

**Table B.13: USB Port**

Pin	Signal	Pin	Signal
1	VCC_DUAL	3	Data0+
2	Data0-	4	GND

**Table B.14: Giga LAN 10/100/1000 Mbps RJ-45 port**

Pin	Signal	Pin	Signal
1	MID0+	5	MID2+
2	MID0-	6	MID2+
3	MID1+	7	MID3+
4	MID1-	8	MID3+

## B.14 Front Panel Audio Connector (FPAUD1)

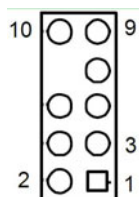

**Table B.15: Front Panel Audio Connector (FPAUD1)**

Pin	Signal
1	MIC2_L
2	AGND
3	MIC2_R
4	PRESENSE
5	LIN2_R
6	MIC_DEC
7	FIO_JD
8	N/A
9	LIN2_L
10	LINEOUT2_DEC

## B.15 8-pin Alarm Board Connector (VOLT1)

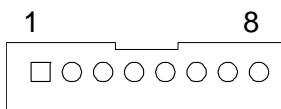

**Table B.16: 8-pin Alarm Board Connector (VOLT1)**

Pin	Signal	Pin	Signal
1	5VSB	5	VCC
2	GND	6	VCC3
3	GND	7	-12V
4	-5V	8	+12V

## B.16 Case Open Connector (JCASE1)

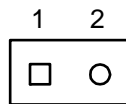

**Table B.17: Case Open Connector (JCASE1)**

Pin	Signal
1	CASEOP
2	GND

## B.17 Front Panel LAN LED Connector (LAN\_LED1,LAN\_LED2)

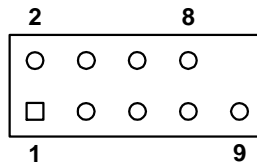

**Table B.18: LAN LED Connector (LANLED1)**

Pin	Signal	Pin	Signal
1	LAN1_LED0_ACT	2	LAN2_LED1_ACT
3	VCC3_LAN1LED	4	VCC3_LAN2LED
5	LAN1_LED1_1000M	6	LAN2_LED2_1000
7	LAN1_LED2_100M	8	LAN2_LED0_100
9	VCC3	10	N/C

**Table B.19: LAN LED Connector (LANLED2)**

Pin	Signal	Pin	Signal
1	LAN3_LED1_ACT	2	LAN4_LED1_ACT
3	VCC3_LAN3LED	4	VCC3_LAN4LED
5	LAN3_LED2_1000M	6	LAN4_LED2_1000M
7	LAN3_LED0_100M	8	LAN4_LED0_100M
9	VCC3	10	NC

## B.18 SPI\_CN1: SPI Flash Card Pin Connector

**Table B.20: SPI\_CN1:SPI Flash Card Pin Connector**

Pin	Signal	Pin	Signal
1	+3VSB	2	GND
3	SPI_CS#	4	SPI_CLK
5	SPI_MISO	6	SPI_MOSI
7	N/A	8	NC

## B.19 GPIO Connector (GPIO1)

**Table B.21: GPIO Connector (GPIO1)**

Pin	Definition	Pin	Definition
1	SIO_GPIO0	2	SIO_GPIO4
3	SIO_GPIO1	4	SIO_GPIO5
5	SIO_GPIO2	6	SIO_GPIO6
7	SIO_GPIO3	8	SIO_GPIO7
9	VCC_GPIO0	10	GND

## B.20 SMBUS1: Connector of SMBUS from PCH

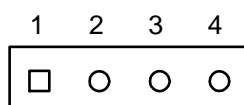

**Table B.22: SMBUS Connector**

Pin	Signal
1	+5V
2	Clock
3	Data
4	GND

## B.21 System I/O Ports

**Table B.23: System I/O ports**

Addr. range (Hex)	Device
000-01F	DMA controller
020-021	Interrupt controller 1, programmable interrupt controller
022-03F	Motherboard resources
040-043	System timer
060-060	Standard PS/2 Keyboard
064-064	Standard PS/2 Keyboard
070-077	Real-time clock, non-maskable interrupt (NMI) mask
081-091	DMA controller
0A0-0A1	Interrupt controller 2, programmable interrupt controller
0C0-0DF	DMA controller
0F0-0F0	Numeric data processor
A35-A36	On-board hardware monitor
2F8-2FF	Serial port 2
778-77F	Printer port (LPT1)
3B0-3BB	Intel HD Graphics
3C0-3DF	Intel HD Graphics
3F8-3FF	Serial port 1

## B.22 Interrupt Assignments

**Table B.24: Interrupt assignments**

Priority	Interrupt#	Interrupt source
1	NMI	Parity error detected
2	IRQ0	Interval timer
3	IRQ1	PS/2 Keyboard
-	IRQ2	Interrupt from controller 2 (cascade)
4	IRQ8	Real-time clock
5	IRQ9	Cascaded to INT 0A (IRQ 2)
6	IRQ10	Intel 8 series/C226 Chipset Family SMBus Controller
7	IRQ11	Available
8	IRQ12	PS/2 mouse
9	IRQ13	Numeric data processor
10	IRQ14	Available
11	IRQ15	Available
12	IRQ3	Serial communication port 2
13	IRQ4	Serial communication port 1
14	IRQ5	Available
15	IRQ6	Available
16	IRQ7	Parallel port 1 (print port)

## B.23 1st MB Memory Map

**Table B.25: 1st MB memory map**

Addr. range (Hex)	Device
E0000h - FFFFFh	BIOS
D0000h - DFFFFh	Unused
C0000h - CFFFFh	VGA BIOS
A0000h - BFFFFh	Video Memory
00000h - 9FFFFh	Base memory

## B.24 Parallel Port (LPT1)

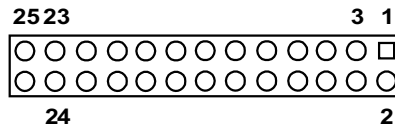

**Table B.26: Parallel Port (LPT1)**

Pin	Signal	Pin	Signal
1	STROBE*	14	GND*
2	AFD*	15	D6
3	D0	16	IGND
4	ERR*	17	D7
5	D1	18	GND
6	INIT*	19	ACK*
7	D2	20	GND
8	SLIN*	21	BUSY
9	D3	22	GND
10	GND	23	PE
11	D4	24	GND
12	GND	25	SLCT
13	D5	26	N/C

**ADVANTECH**

*Enabling an Intelligent Planet*

**[www.advantech.com](http://www.advantech.com)**

Please verify specifications before quoting. This guide is intended for reference purposes only.

All product specifications are subject to change without notice.

No part of this publication may be reproduced in any form or by any means, electronic, photocopying, recording or otherwise, without prior written permission of the publisher.

All brand and product names are trademarks or registered trademarks of their respective companies.

© Advantech Co., Ltd. 2017